

TECHNOLOGY IN MOTION





















MACO PROTECT

DOOR LOCKS



Catalogue 2016



N^o	Part number		Shootbolt width
	Packing unit		Finger operated door shootbolt length
	Handle centre (HC)		Sash rebate width (SRW), standard
	Backset (BS)	G-TS =	Handle operated door lock
	Spindle size	Z-TS =	Cylinder operated door lock
	Handle height (HH)	Z-TF =	Triple Latch Door Lock
	Sash rebate height (SRH)	Z-TA =	Automatic Door Lock Triple Latch Lock
	Faceplate width	Z-RS =	Cylinder operated mortise lock
	Number of security cams (i.S.)	MF =	Multifunctional latch
	Number of standard cams	ZS =	Additional lock
L	Overall component length	B-TV =	Balcony door lock
W	Width	MM =	Multi-Matic
H	Height	U =	U-faceplate
	Right-angled latch plate dimensions	PZ	Profile cylinder (PC)
	Frontal faceplate height	RZ	Round cylinder (RC)
	Back faceplate height	i.S. =	Security Cam
	Cutting measure	VZ =	Standard cam
	Radius	HO =	Hook (protruding upwards)
	Shootbolt throw	BO =	Bolt
		HO-BO =	Hook & bolt combination
		MF-BO =	Multifunctional latch & bolt combination
		MF-HO =	Multifunctional latch & hook combination
		SFG =	French casement drive gear
		EV =	End piece
		K+ =	Case position above handle height



Dear MACO customer,

You are holding our new order catalogue in your hands. Our main aim was to present our product range in a simple and easy-to-understand manner in order to provide you with a practical working document. In addition to this catalogue, our package leaflet and assembly instructions will help you to process and install our products correctly. These are available to download from extranet.maco.eu or www.maco.eu.

Our products help to ensure that windows, doors and large-scale elements offer optimum function and security. As a premium manufacturer, that carries out its business according to the highest standards, the optimum quality and functionality of our hardware is our top priority. While we guarantee the best possible product characteristics for our hardware components, the responsibility for professional installation and correct fixing lies in your hands.

We want to support you, as a dealer or fabricator, with your responsibility for the safety of your products. Our binding assembly instructions and package leaflets provide information about the general use and processing of our hardware. To ensure the best fabrication and attachment of the hardware components – to suit the relevant installation situation, such as strength and profile design of the timber, arrangement of chambers and reinforcement in PVC profiles, etc. , you can have elements tested and evaluated at our certified test centre: an air permeability and driving rain test as well as a pull-out test will help you to meet CE marking requirements. This means that you can rest assured that you are meeting all the standards and directives applicable to you.

You can find information about how to properly store our hardware components in our operation and maintenance instructions or the VHBH guideline of the Quality Assurance Association: Locks and Hardware (www.fvsb.de).

Important for dealers: *MACO supplies its products with the corresponding number of package leaflets. As a dealer, you are responsible for enclosing the correct number of package leaflets with the products sold by you. Also, please ensure that you make your customers aware of the relevant binding instructions and legal aspects of the document.*

We also provide you with operation and maintenance instructions for end users for you to pass on to your customers. These can also be downloaded from the MACO website (www.maco.eu).

We are offering an option in our extranet (extranet.maco.eu) with our online catalogue, which, in addition to highly up-to-date information, also offers the advantage of extensive additional technical information for all components. You can obtain access details from your contact partner in field sales.

All of our printed documentation is continuously revised and expanded. Please make sure that you are working with our most current documentation. All of our documentation is available for download at extranet.maco.eu or www.maco.eu. We hope that the catalogue will prove to be a valuable tool for your daily work. We wish you every success and hope to see you online soon.

Please fill in completely

We confirm receipt and approvingly acknowledge its contents.

Stamp:

_____ *Please print your name in capital letters*

Date: _____ Signature: _____

MACO sales manager: _____

**MACO
PROTECT**





1	Technical and general information	1	7
2	Z-TA – Automatic Door Lock Triple Latch	2	13
3	Z-TF Triple Latch Door Lock	3	33
4	Z-TS Cylinder Operated Door Lock	4	71
5	G-TS Lever Operated Door Lock	5	111
6	G-TA Lever Operated Automatic Door Lock	6	135
7	Z-RS - Mortise Door Lock	7	137
8	B-TV - Balcony Door Lock	8	141
9	Striker plates	9	145
10	French casement drive gear	10	175
11	Shootbolts	11	181
12	Accessories	12	185
13	Jigs	13	203
14	Directory		

**MACO
PROTECT**





1 Technical and general information

1.1	How to use the catalogue	8
1.2	Product liability information	9
1.3	Innovative MACO top-hat faceplate solution	10
1.4	Certificates and guarantees	11
1.5	General Terms and Conditions	12



1 Technical and general information

1.1 How to use the catalogue

If not otherwise specified, all dimensions are stated in millimetres and packing units in items per box.

Drawings and diagrams are not to scale.

The content of this document is constantly being updated, so regular calibration is necessary. The current ver-

sion is downloadable from the Extranet (extranet.maco.eu) or from our website (www.maco-couk.net).

Please send comments or suggestions about our instructions by email to feedback@maco.eu.



1.2 Product liability information

"PROTECT" Door Locks

In accordance with the manufacturer's liability for his products, which is defined in the "Product Liability Law" (§ 1 PHG), the following information is binding and should be considered for the entire "Protect" door lock product range. Non-compliance shall relieve the manufacturer of all liability.

1.2.1 Product information and conventional use

In terms of this definition, the door lock product range includes (door leaf and frame) fittings for timber, PVCu and aluminium doors and their corresponding material combinations. The functions of the door locks fundamentally consist of

- a) closing doors (keeping the door closed via latches) and
- b) locking the door (securing the door via additional locking elements).

Every MACO door lock is offered as a multipoint lock and is used for locking systems for vertically fitted doors. The MACO door lock product range offers two door lock systems that differ in their functionality:

1.2.1.1 Door lock with handle actuation (G-TS)

When closing and locking the G-TS, the locking elements are extended by actuating the handle upwards. After securing the door, the door lock is activated by turning the key through 360°. The handle can no longer be depressed; the locking elements are locked in place. The G-TS can be unlocked again by turning the key in the cylinder lock anti-clockwise through one rotation; the locking elements are no longer locked in place. By pressing the handle downwards, the locking elements are retracted at the same time as the latch and the door is therefore open again.

Important: Door handles must be fitted to the door interior and exterior for a handle actuated door lock!

1.2.1.2 Door lock with cylinder actuation (Z-TS / Z-TF)

After closing the door, the Z-TS / Z-TF is locked by turning the key in the profile cylinder through two 360° rotations. When doing this, the locking elements are extended into the striker plates and the door is locked. The Z-TS / Z-TF can be unlocked by turning the key through two anti-clockwise rotations; the latch can be retracted by actuating the handle and by turning the key in the profile cylinder.

A knob can be fitted to the door exterior for door locks with cylinder actuation.

The MACO multipoint locks are intended for combination with commercial profile cylinders according to DIN 18252 / EN 1303. The lock cases correspond to DIN 18251. In special cases the fitter of MACO door lock systems must ensure that the cylinder lock selected is suitable for the intended installation and that its functionality is guaranteed for the intended application.

1.2.2 Product installation

The MACO multipoint locks should only be fitted by specialists. The MACO door locks must be able to be inserted easily into the recesses provided in the fitting groove for lock cases, hook locks and finger bolt locks. Any component forced into the recesses can impair the functionality of the entire door lock system.

The lock faceplate must be screwed into the eurogroove using appropriate tools (torque function!). The striker plates (standard striker plates, EH Security-striker plates, hook and finger bolt striker plates) must be fitted in such a way that they allow the locking elements to be retracted unhindered and that even fully extended locking elements are not able to protrude as far as the stop in the striker plate.

To ensure the correct installation of the components, notches are punched on the lock cover and on the respective striker plate, which designate the optimal position of the striker plate to the door lock cover.

The MACO multipoint locks can be fitted to many types of house or side entrance doors. It should be noted that these components are not suitable to accommodate alterations in shape or alterations of the seal closure as a result of variations in temperature or building alterations.

1.2.3 Non-intended use and incorrect use

Please refer to the instruction manual for, among other things, incorrect use and non-intended use.

1.2.4 Product maintenance and information duty

In order to ensure perfect functionality of the MACO multipoint locks:

the necessary information and instructions are to be transferred to the appropriate persons;

the applicable standards are to be observed;

MACO multipoint locks must be used according to their defined function;

the manufacturer's regulations concerning the configuration of the hardware is to be observed;

maintenance and care instructions are to be followed;

faults may only be repaired by specialist personnel.

1.2.5 Product performance

Unless the product performances are explicitly specified in our catalogues and brochures, the requirements of the individual locking systems must be agreed with us. The information concerning product performance solely refers to the combination of MACO original parts. The efficiency of locking systems depends on, among other things, frequency of use, method of operation, environmental influences, maintenance and care.

1.3 Innovative MACO top-hat faceplate solution

Top hat faceplate advantages (F-24/16x3 mm)

Stops dirt deposits between the faceplate and the fitting groove

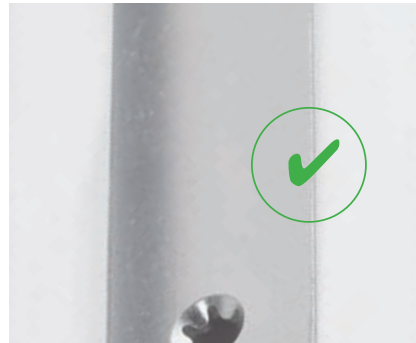
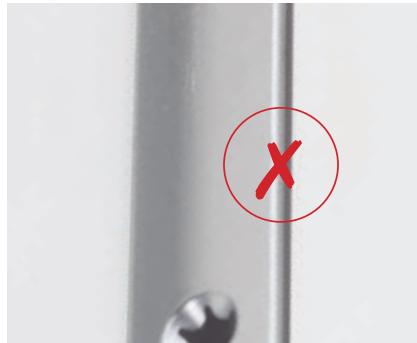

Protruding lock routings are safely covered

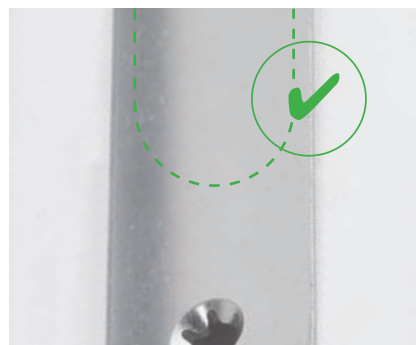

No reduction in the working air-gap as there would be with a 24 x 3 mm flat faceplate

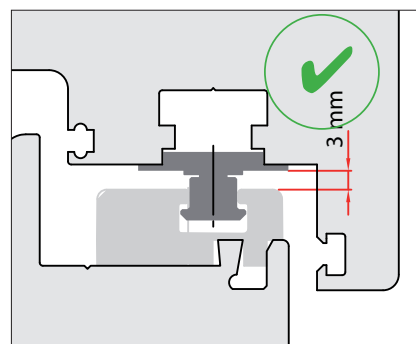
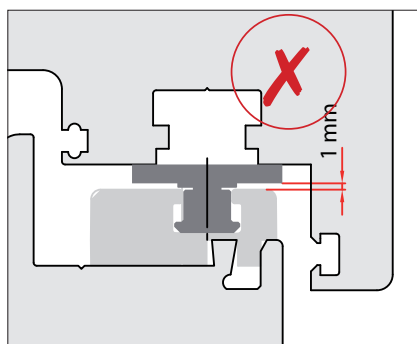



1.4 Certificates and guarantees

MACO ensures high quality, not only with ongoing continuous internal testing, but also through external auditing by renowned, independent institutes. Copies of all our independent test certificates, covering our quality, safety and environmental management systems, as well as our product guarantees are

available to download from our website www.maco.eu, customers can access them directly from our customer extranet portal (extranet.maco.eu). In addition our safety descriptions relating to dangerous substances (REACH Declaration) are available, covering all MACO products.



1.5 General Terms and Conditions

Our general terms and conditions are available for download from our website (www.maco.eu) or from our extranet (extranet.maco.eu).



2 Z-TA – Automatic Door Lock Triple Latch

2.1	Hardware overview Z-TA automatic	14
2.2	Door lock Z-TA with 2 MF-HO	19
2.2.1	Door lock Z-TA Automatic PT-M with 2 MF-HO E92 F-16	19
2.2.2	Door lock Z-TA Automatic PT-M with 2 MF-HO E92 F-16 K+605	19
2.2.3	Door lock Z-TA Automatic PT-M with 2 MF-HO E92 F-16 K+980	20
2.2.4	Door lock Z-TA Automatic PT-M with 2 MF-HO E92 F-20	20
2.2.5	Door lock Z-TA Automatic PT-M with 2 MF-HO E92 F-20 K+605	21
2.2.6	Door lock Z-TA Automatic PT-M with 2 MF-HO E92 F-20 K+980	21
2.2.7	Door lock Z-TA Automatic PT-M with 2 MF-HO E92 F-20 HH 890	22
2.2.8	Door lock Z-TA Automatic PT-M with 2 MF-HO E92 F-24	22
2.2.9	Door lock Z-TA Automatic PT-M with 2 MF-HO E92 F-24 K+605	23
2.2.10	Door lock Z-TA Automatic PT-M with 2 MF-HO E92 F-24 K+980	23
2.2.11	Door lock Z-TA Automatic PT-M with 2 MF-HO E92 F-24/16 top-hat faceplate	24
2.2.12	Door lock Z-TA Automatic PT-M with 2 MF-HO E92 F-24/16 K+605	24
2.2.13	Door lock Z-TA Automatic PT-M with 2 MF-HO E92 F-24/16 K+980	25
2.2.14	Door lock Z-TA Automatic PT-M with 2 MF-HO E92 U-6x24x6	25
2.2.15	Door lock Z-TA Automatic PT-M with 2 MF-HO E92 U-6x24x6 HH885	25
2.2.16	Door lock Z-TA Automatic PT-M with 2 MF-HO E92 U-6x24x6 K+605	26
2.2.17	Door lock Z-TA Automatic PT-M with 2 MF-HO E92 U-6x24x6 K+605 HH885	26
2.2.18	Door lock Z-TA Automatic PT-M with 2 MF-HO E92 U-6x24x6 K+980	26
2.2.19	Door lock Z-TA Automatic PT-M with 2 MF-HO E92 U-6x24x6 K+980 HH885	27
2.2.20	Door lock Z-TA Automatic PT-M with 2 MF-HO E94 F-16	27
2.2.21	Door lock Z-TA Automatic PT-M with 2 MF-HO E94 F-16 K+605	27
2.2.22	Door lock Z-TA Automatic PT-M with 2 MF-HO E94 F-16 K+980	28
2.2.23	Door lock Z-TA Automatic PT-M with 2 MF-HO E94 F-20	28
2.2.24	Door lock Z-TA Automatic PT-M with 2 MF-HO E94 F-20 K+605	28
2.2.25	Door lock Z-TA Automatic PT-M with 2 MF-HO E94 F-20 K+980	29
2.2.26	Door lock Z-TA Automatic PT-M with 2 MF-HO E94 F-24	29
2.2.27	Door lock Z-TA Automatic PT-M with 2 MF-HO E94 F-24 K+605	29
2.2.28	Door lock Z-TA Automatic PT-M with 2 MF-HO E94 F-24 K+980	30
2.2.29	Door lock Z-TA Automatic PT-M with 2 MF-HO E94 F-24/16 top-hat faceplate	30
2.2.30	Door lock Z-TA Automatic PT-M with 2 MF-HO E94 F-24/16 K+605	30
2.2.31	Door lock Z-TA Automatic PT-M with 2 MF-HO E94 F-24/16 K+980	31
2.2.32	Door lock Z-TA Automatic PT-M with 2 MF-HO E94 U-6x24x6	31
2.2.33	Door lock Z-TA Automatic PT-M with 2 MF-HO E94 U-6x24x6 K+605	31
2.2.34	Door lock Z-TA Automatic PT-M with 2 MF-HO E94 U-6x24x6 K+980	31

2 Z-TA – Automatic Door Lock Triple Latch Lock

2.1 Hardware overview Z-TA automatic

① shortening faceplate

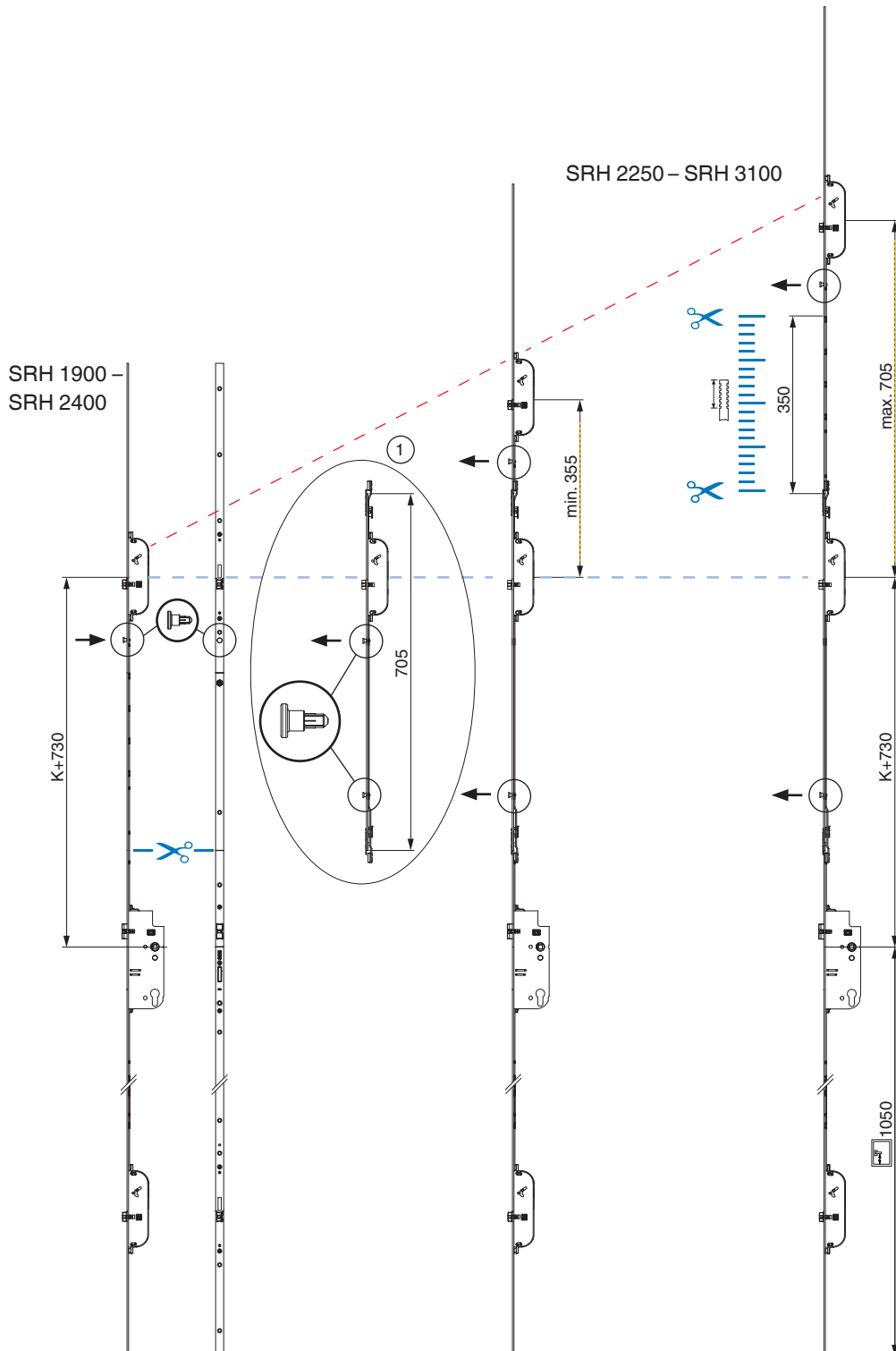

- ① shortening faceplate
- ② extension faceplate

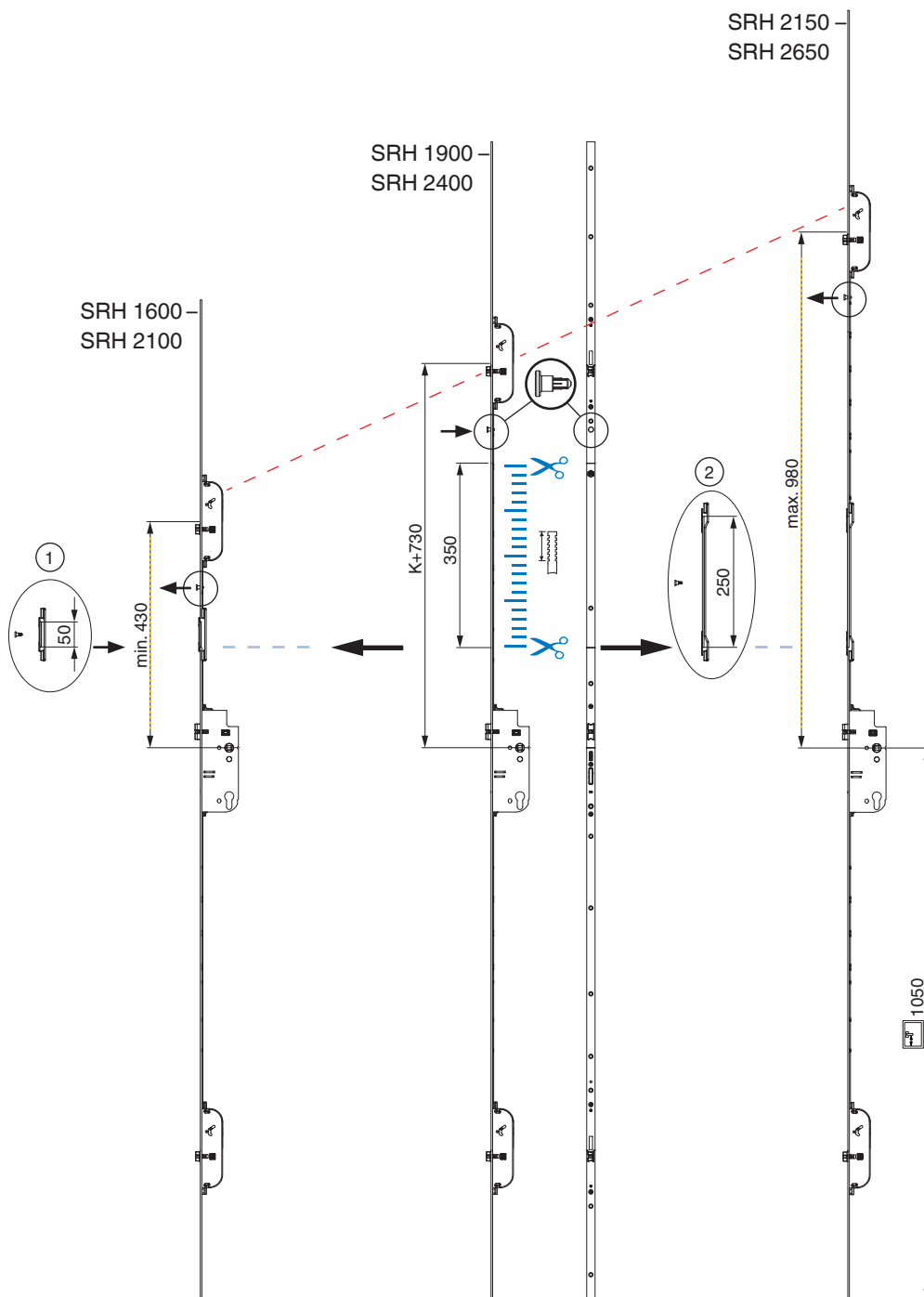



2 MF-HO
1- & 2-sashed

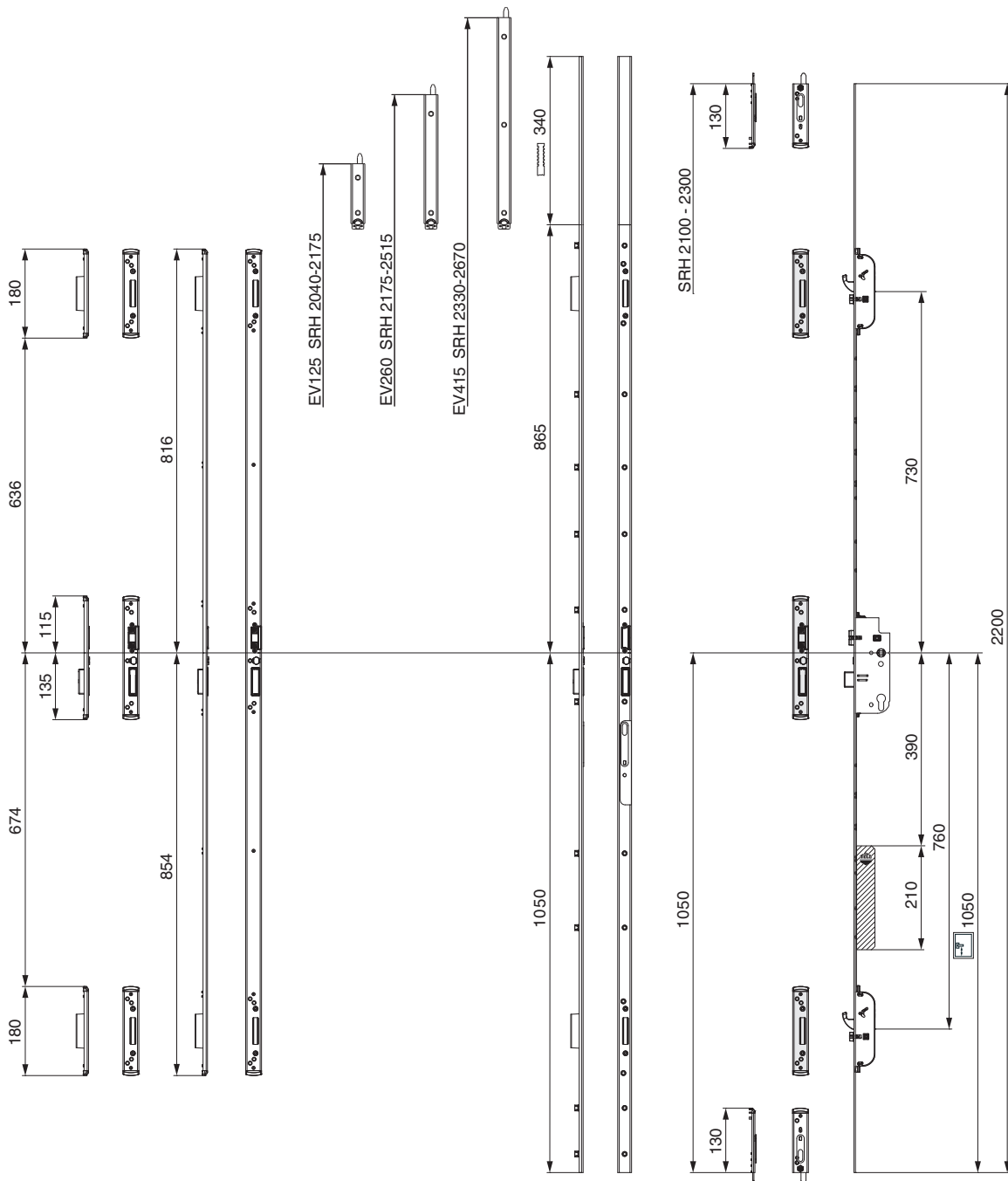

Motor for Comfort opening



2 MF-HO K+605

1- & 2-sashed

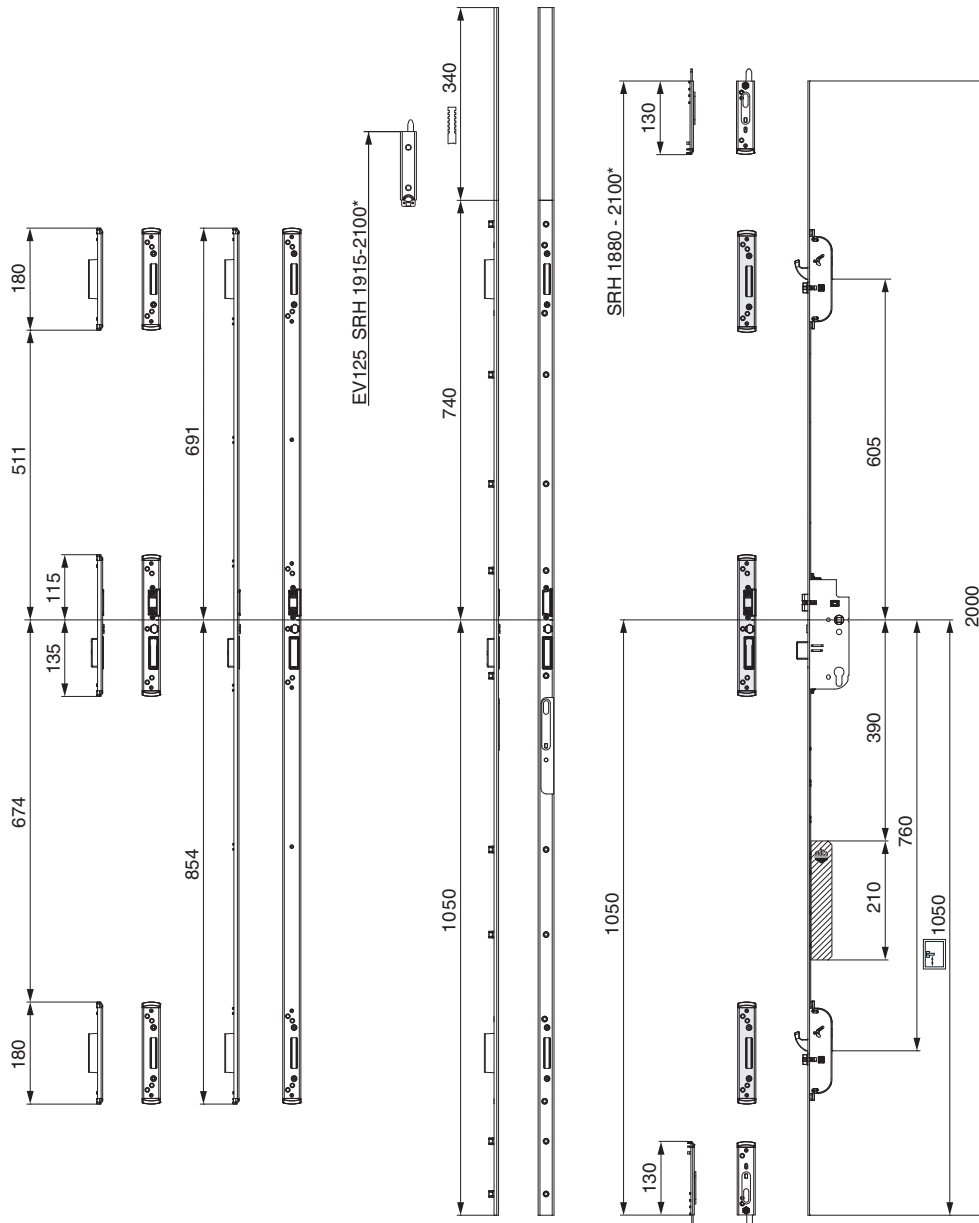

* Please use cover plates for SRH above 2000 mm!

☛ Motor for Comfort opening



2 MF-HO K+980

1- & 2-sashed

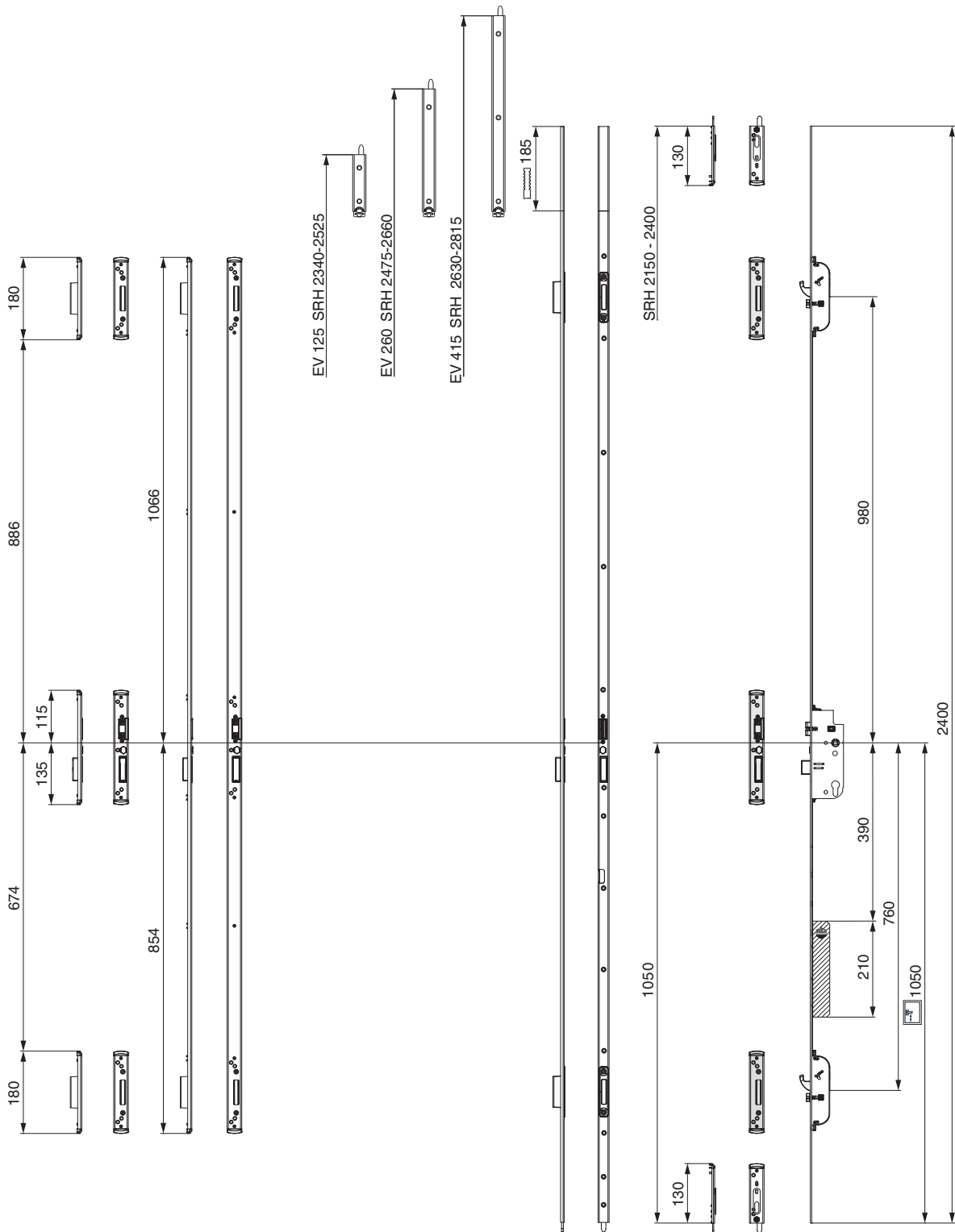

Motor for Comfort opening

2.2 Door lock Z-TA with 2 MF-HO

Flat faceplate 16 mm

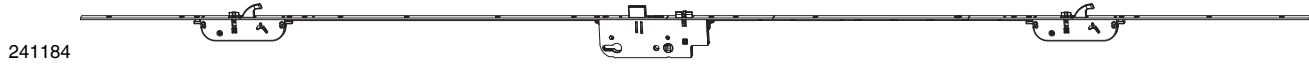

241184

2.2.1 Door lock Z-TA Automatic PT-M with 2 MF-HO E92 F-16



modular	silver	92	35	8	1.050	2.000 - 2.200	16	2.200	5	No
				10	1.050	2.000 - 2.200	16	2.200	5	241180
			40	8	1.050	2.000 - 2.200	16	2.200	5	241181
				10	1.050	2.000 - 2.200	16	2.200	5	241651
			45	8	1.050	2.000 - 2.200	16	2.200	5	241182
				10	1.050	2.000 - 2.200	16	2.200	5	241652
			50	8	1.050	2.000 - 2.200	16	2.200	5	241183
				10	1.050	2.000 - 2.200	16	2.200	5	241653
			55	8	1.050	2.000 - 2.200	16	2.200	5	241184
				10	1.050	2.000 - 2.200	16	2.200	5	241654
			60	8	1.050	2.000 - 2.200	16	2.200	5	241185
				10	1.050	2.000 - 2.200	16	2.200	5	241655
			65	8	1.050	2.000 - 2.200	16	2.200	5	241186
				10	1.050	2.000 - 2.200	16	2.200	5	241656
			70	8	1.050	2.000 - 2.200	16	2.200	5	241187
				10	1.050	2.000 - 2.200	16	2.200	5	241657
			80	8	1.050	2.000 - 2.200	16	2.200	5	241188
				10	1.050	2.000 - 2.200	16	2.200	5	241658

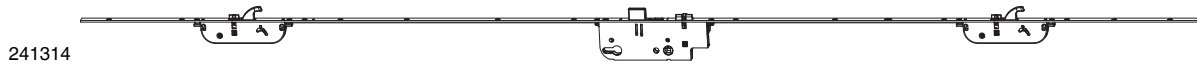

241314







2.2.2 Door lock Z-TA Automatic PT-M with 2 MF-HO E92 F-16 K+605



modular	silver	92	35	8	1.050	1.800 - 2.000	16	2.000	5	No
				10	1.050	1.800 - 2.000	16	2.000	5	241700
			40	8	1.050	1.800 - 2.000	16	2.000	5	241311
				10	1.050	1.800 - 2.000	16	2.000	5	241701
			45	8	1.050	1.800 - 2.000	16	2.000	5	241312
				10	1.050	1.800 - 2.000	16	2.000	5	241702
			50	8	1.050	1.800 - 2.000	16	2.000	5	241313
				10	1.050	1.800 - 2.000	16	2.000	5	241703
			55	8	1.050	1.800 - 2.000	16	2.000	5	241314
				10	1.050	1.800 - 2.000	16	2.000	5	241704
			60	8	1.050	1.800 - 2.000	16	2.000	5	241315
				10	1.050	1.800 - 2.000	16	2.000	5	241705
			65	8	1.050	1.800 - 2.000	16	2.000	5	241316
				10	1.050	1.800 - 2.000	16	2.000	5	241706
			70	8	1.050	1.800 - 2.000	16	2.000	5	241317
				10	1.050	1.800 - 2.000	16	2.000	5	241707
			80	8	1.050	1.800 - 2.000	16	2.000	5	241318
				10	1.050	1.800 - 2.000	16	2.000	5	241708

241444







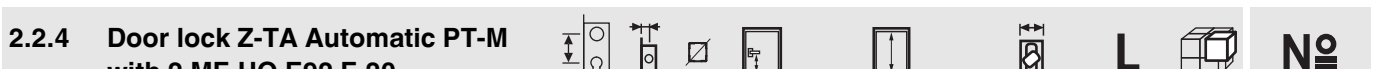

2.2.3 Door lock Z-TA Automatic PT-M with 2 MF-HO E92 F-16 K+980								L		No
modular	silver	92	35	8	1.050	2.200 - 2.400	16	2.400	5	241440
				10	1.050	2.200 - 2.400	16	2.400	5	241750
			40	8	1.050	2.200 - 2.400	16	2.400	5	241441
				10	1.050	2.200 - 2.400	16	2.400	5	241751
			45	8	1.050	2.200 - 2.400	16	2.400	5	241442
				10	1.050	2.200 - 2.400	16	2.400	5	241752
			50	8	1.050	2.200 - 2.400	16	2.400	5	241443
				10	1.050	2.200 - 2.400	16	2.400	5	241753
			55	8	1.050	2.200 - 2.400	16	2.400	5	241444
				10	1.050	2.200 - 2.400	16	2.400	5	241754
			60	8	1.050	2.200 - 2.400	16	2.400	5	241445
				10	1.050	2.200 - 2.400	16	2.400	5	241755
			65	8	1.050	2.200 - 2.400	16	2.400	5	241446
				10	1.050	2.200 - 2.400	16	2.400	5	241756
			70	8	1.050	2.200 - 2.400	16	2.400	5	241447
				10	1.050	2.200 - 2.400	16	2.400	5	241757
			80	8	1.050	2.200 - 2.400	16	2.400	5	241448
				10	1.050	2.200 - 2.400	16	2.400	5	241758

Flat faceplate 20 mm







241214



2.2.4 Door lock Z-TA Automatic PT-M with 2 MF-HO E92 F-20								L		No
modular	silver	92	35	8	1.050	2.000 - 2.200	20	2.200	5	241210
				10	1.050	2.000 - 2.200	20	2.200	5	241660
			40	8	1.050	2.000 - 2.200	20	2.200	5	241211
				10	1.050	2.000 - 2.200	20	2.200	5	241661
			45	8	1.050	2.000 - 2.200	20	2.200	5	241212
				10	1.050	2.000 - 2.200	20	2.200	5	241662
			50	8	1.050	2.000 - 2.200	20	2.200	5	241213
				10	1.050	2.000 - 2.200	20	2.200	5	241663
			55	8	1.050	2.000 - 2.200	20	2.200	5	241214
				10	1.050	2.000 - 2.200	20	2.200	5	241664
			60	8	1.050	2.000 - 2.200	20	2.200	5	241215
				10	1.050	2.000 - 2.200	20	2.200	5	241665
			65	8	1.050	2.000 - 2.200	20	2.200	5	241216
				10	1.050	2.000 - 2.200	20	2.200	5	241666
			70	8	1.050	2.000 - 2.200	20	2.200	5	241217
				10	1.050	2.000 - 2.200	20	2.200	5	241667
			80	8	1.050	2.000 - 2.200	20	2.200	5	241218
				10	1.050	2.000 - 2.200	20	2.200	5	241668







241344



2.2.5 Door lock Z-TA Automatic PT-M with 2 MF-HO E92 F-20 K+605							L		№	
modular	silver	92	35	8	1.050	1.800 - 2.000	20	2.000	5	241340
				10	1.050	1.800 - 2.000	20	2.000	5	241710
			40	8	1.050	1.800 - 2.000	20	2.000	5	241341
				10	1.050	1.800 - 2.000	20	2.000	5	241711
			45	8	1.050	1.800 - 2.000	20	2.000	5	241342
				10	1.050	1.800 - 2.000	20	2.000	5	241712
			50	8	1.050	1.800 - 2.000	20	2.000	5	241343
				10	1.050	1.800 - 2.000	20	2.000	5	241713
			55	8	1.050	1.800 - 2.000	20	2.000	5	241344
				10	1.050	1.800 - 2.000	20	2.000	5	241714
			60	8	1.050	1.800 - 2.000	20	2.000	5	241345
				10	1.050	1.800 - 2.000	20	2.000	5	241715
			65	8	1.050	1.800 - 2.000	20	2.000	5	241346
				10	1.050	1.800 - 2.000	20	2.000	5	241716
			70	8	1.050	1.800 - 2.000	20	2.000	5	241347
				10	1.050	1.800 - 2.000	20	2.000	5	241717
			80	8	1.050	1.800 - 2.000	20	2.000	5	241348
				10	1.050	1.800 - 2.000	20	2.000	5	241718







241474



2.2.6 Door lock Z-TA Automatic PT-M with 2 MF-HO E92 F-20 K+980							L		№	
modular	silver	92	35	8	1.050	2.200 - 2.400	20	2.400	5	241470
				10	1.050	2.200 - 2.400	20	2.400	5	241760
			40	8	1.050	2.200 - 2.400	20	2.400	5	241471
				10	1.050	2.200 - 2.400	20	2.400	5	241761
			45	8	1.050	2.200 - 2.400	20	2.400	5	241472
				10	1.050	2.200 - 2.400	20	2.400	5	241762
			50	8	1.050	2.200 - 2.400	20	2.400	5	241473
				10	1.050	2.200 - 2.400	20	2.400	5	241763
			55	8	1.050	2.200 - 2.400	20	2.400	5	241474
				10	1.050	2.200 - 2.400	20	2.400	5	241764
			60	8	1.050	2.200 - 2.400	20	2.400	5	241475
				10	1.050	2.200 - 2.400	20	2.400	5	241765
			65	8	1.050	2.200 - 2.400	20	2.400	5	241476
				10	1.050	2.200 - 2.400	20	2.400	5	241766
			70	8	1.050	2.200 - 2.400	20	2.400	5	241477
				10	1.050	2.200 - 2.400	20	2.400	5	241767
			80	8	1.050	2.200 - 2.400	20	2.400	5	241478
				10	1.050	2.200 - 2.400	20	2.400	5	241768









241674

2.2.7 Door lock Z-TA Automatic PT-M with 2 MF-HO E92 F-20 HH 890								L		No
modular	silver	92	35	8	890	1.950 - 2.000	20 / R	1.750	5	241670
			45	8	890	1.950 - 2.000	20 / R	1.750	5	241672
			55	8	890	1.950 - 2.000	20 / R	1.750	5	241674
			10	890	1.950 - 2.000	20 / R	1.750	5		241224
			60	8	890	1.950 - 2.000	20 / R	1.750	5	241675
			10	890	1.950 - 2.000	20 / R	1.750	5		241225
			65	8	890	1.950 - 2.000	20 / R	1.750	5	241676
			10	890	1.950 - 2.000	20 / R	1.750	5		241226
			70	8	890	1.950 - 2.000	20 / R	1.750	5	241677
			10	890	1.950 - 2.000	20 / R	1.750	5		241227
			80	8	890	1.950 - 2.000	20 / R	1.750	5	241678
			10	890	1.950 - 2.000	20 / R	1.750	5		241228

Flat faceplate 24 mm



241254

2.2.8 Door lock Z-TA Automatic PT-M with 2 MF-HO E92 F-24								L		No
modular	silver	92	35	8	1.050	2.000 - 2.200	24	2.200	5	241250
			10	1.050	2.000 - 2.200	24	2.200	5		241680
			40	8	1.050	2.000 - 2.200	24	2.200	5	241251
			10	1.050	2.000 - 2.200	24	2.200	5		241681
			45	8	1.050	2.000 - 2.200	24	2.200	5	241252
			10	1.050	2.000 - 2.200	24	2.200	5		241682
			50	8	1.050	2.000 - 2.200	24	2.200	5	241253
			10	1.050	2.000 - 2.200	24	2.200	5		241683
			55	8	1.050	2.000 - 2.200	24	2.200	5	241254
			10	1.050	2.000 - 2.200	24	2.200	5		241684
			60	8	1.050	2.000 - 2.200	24	2.200	5	241255
			10	1.050	2.000 - 2.200	24	2.200	5		241685
			65	8	1.050	2.000 - 2.200	24	2.200	5	241256
			10	1.050	2.000 - 2.200	24	2.200	5		241686
			70	8	1.050	2.000 - 2.200	24	2.200	5	241257
			10	1.050	2.000 - 2.200	24	2.200	5		241687
			80	8	1.050	2.000 - 2.200	24	2.200	5	241258
			10	1.050	2.000 - 2.200	24	2.200	5		241688



241384



2.2.9 Door lock Z-TA Automatic PT-M with 2 MF-HO E92 F-24 K+605										No
modular	silver	92	35	8	1.050	1.800 - 2.000	24	2.000	5	241380
				10	1.050	1.800 - 2.000	24	2.000	5	241730
		40	8	1.050	1.800 - 2.000	24	2.000	5	241381	
			10	1.050	1.800 - 2.000	24	2.000	5	241731	
		45	8	1.050	1.800 - 2.000	24	2.000	5	241382	
			10	1.050	1.800 - 2.000	24	2.000	5	241732	
		50	8	1.050	1.800 - 2.000	24	2.000	5	241383	
			10	1.050	1.800 - 2.000	24	2.000	5	241733	
		55	8	1.050	1.800 - 2.000	24	2.000	5	241384	
			10	1.050	1.800 - 2.000	24	2.000	5	241734	
		60	8	1.050	1.800 - 2.000	24	2.000	5	241385	
			10	1.050	1.800 - 2.000	24	2.000	5	241735	
		65	8	1.050	1.800 - 2.000	24	2.000	5	241386	
			10	1.050	1.800 - 2.000	24	2.000	5	241736	
		70	8	1.050	1.800 - 2.000	24	2.000	5	241387	
			10	1.050	1.800 - 2.000	24	2.000	5	241737	
		80	8	1.050	1.800 - 2.000	24	2.000	5	241388	
			10	1.050	1.800 - 2.000	24	2.000	5	241738	

241514



2.2.10 Door lock Z-TA Automatic PT-M with 2 MF-HO E92 F-24 K+980										No
modular	silver	92	35	8	1.050	2.200 - 2.400	24	2.400	5	241510
				10	1.050	2.200 - 2.400	24	2.400	5	241780
		40	8	1.050	2.200 - 2.400	24	2.400	5	241511	
			10	1.050	2.200 - 2.400	24	2.400	5	241781	
		45	8	1.050	2.200 - 2.400	24	2.400	5	241512	
			10	1.050	2.200 - 2.400	24	2.400	5	241782	
		50	8	1.050	2.200 - 2.400	24	2.400	5	241513	
			10	1.050	2.200 - 2.400	24	2.400	5	241783	
		55	8	1.050	2.200 - 2.400	24	2.400	5	241514	
			10	1.050	2.200 - 2.400	24	2.400	5	241784	
		60	8	1.050	2.200 - 2.400	24	2.400	5	241515	
			10	1.050	2.200 - 2.400	24	2.400	5	241785	
		65	8	1.050	2.200 - 2.400	24	2.400	5	241516	
			10	1.050	2.200 - 2.400	24	2.400	5	241786	
		70	8	1.050	2.200 - 2.400	24	2.400	5	241517	
			10	1.050	2.200 - 2.400	24	2.400	5	241787	
		80	8	1.050	2.200 - 2.400	24	2.400	5	241518	
			10	1.050	2.200 - 2.400	24	2.400	5	241788	

Top hat faceplate 24/16 mm

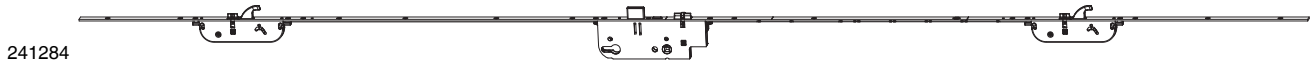

241284

2.2.11 Door lock Z-TA Automatic PT-M with 2 MF-HO E92 F-24/16 top-hat faceplate



modular	silver	92	35	8	1.050	2.000 - 2.200	24/16	2.200	5	No
				10	1.050	2.000 - 2.200	24/16	2.200	5	241280
			40	8	1.050	2.000 - 2.200	24/16	2.200	5	241281
				10	1.050	2.000 - 2.200	24/16	2.200	5	241691
			45	8	1.050	2.000 - 2.200	24/16	2.200	5	241282
				10	1.050	2.000 - 2.200	24/16	2.200	5	241692
			50	8	1.050	2.000 - 2.200	24/16	2.200	5	241283
				10	1.050	2.000 - 2.200	24/16	2.200	5	241693
			55	8	1.050	2.000 - 2.200	24/16	2.200	5	241284
				10	1.050	2.000 - 2.200	24/16	2.200	5	241694
			60	8	1.050	2.000 - 2.200	24/16	2.200	5	241285
				10	1.050	2.000 - 2.200	24/16	2.200	5	241695
			65	8	1.050	2.000 - 2.200	24/16	2.200	5	241286
				10	1.050	2.000 - 2.200	24/16	2.200	5	241696
			70	8	1.050	2.000 - 2.200	24/16	2.200	5	241287
				10	1.050	2.000 - 2.200	24/16	2.200	5	241697
			80	8	1.050	2.000 - 2.200	24/16	2.200	5	241288
				10	1.050	2.000 - 2.200	24/16	2.200	5	241698

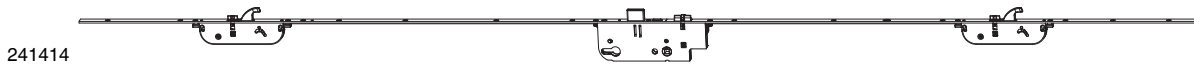

241414

2.2.12 Door lock Z-TA Automatic PT-M with 2 MF-HO E92 F-24/16 K+605



modular	silver	92	35	8	1.050	1.800 - 2.000	24/16	2.000	5	No
				10	1.050	1.800 - 2.000	24/16	2.000	5	241410
			40	8	1.050	1.800 - 2.000	24/16	2.000	5	241411
				10	1.050	1.800 - 2.000	24/16	2.000	5	241741
			45	8	1.050	1.800 - 2.000	24/16	2.000	5	241412
				10	1.050	1.800 - 2.000	24/16	2.000	5	241742
			50	8	1.050	1.800 - 2.000	24/16	2.000	5	241413
				10	1.050	1.800 - 2.000	24/16	2.000	5	241743
			55	8	1.050	1.800 - 2.000	24/16	2.000	5	241414
				10	1.050	1.800 - 2.000	24/16	2.000	5	241744
			60	8	1.050	1.800 - 2.000	24/16	2.000	5	241415
				10	1.050	1.800 - 2.000	24/16	2.000	5	241745
			65	8	1.050	1.800 - 2.000	24/16	2.000	5	241416
				10	1.050	1.800 - 2.000	24/16	2.000	5	241746
			70	8	1.050	1.800 - 2.000	24/16	2.000	5	241417
				10	1.050	1.800 - 2.000	24/16	2.000	5	241747
			80	8	1.050	1.800 - 2.000	24/16	2.000	5	241418
				10	1.050	1.800 - 2.000	24/16	2.000	5	241748

241544



2.2.13 Door lock Z-TA Automatic PT-M with 2 MF-HO E92 F-24/16 K+980



modular	silver	92	35	8	1.050	2.200 - 2.400	24/16	2.400	5	No
				10	1.050	2.200 - 2.400	24/16	2.400	5	241540
			40	8	1.050	2.200 - 2.400	24/16	2.400	5	241541
				10	1.050	2.200 - 2.400	24/16	2.400	5	241791
			45	8	1.050	2.200 - 2.400	24/16	2.400	5	241542
				10	1.050	2.200 - 2.400	24/16	2.400	5	241792
			50	8	1.050	2.200 - 2.400	24/16	2.400	5	241543
				10	1.050	2.200 - 2.400	24/16	2.400	5	241793
			55	8	1.050	2.200 - 2.400	24/16	2.400	5	241544
				10	1.050	2.200 - 2.400	24/16	2.400	5	241794
			60	8	1.050	2.200 - 2.400	24/16	2.400	5	241545
				10	1.050	2.200 - 2.400	24/16	2.400	5	241795
			65	8	1.050	2.200 - 2.400	24/16	2.400	5	241546
				10	1.050	2.200 - 2.400	24/16	2.400	5	241796
			70	8	1.050	2.200 - 2.400	24/16	2.400	5	241547
				10	1.050	2.200 - 2.400	24/16	2.400	5	241797
			80	8	1.050	2.200 - 2.400	24/16	2.400	5	241548
				10	1.050	2.200 - 2.400	24/16	2.400	5	241798

U-faceplate 6x24x6 mm

241574

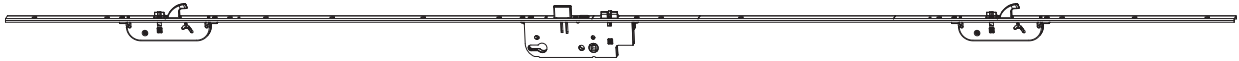

2.2.14 Door lock Z-TA Automatic PT-M with 2 MF-HO E92 U-6x24x6



modular	silver	92	35	8	1.050	2.000 - 2.200	24	2.200	5	No
				10	1.050	2.000 - 2.200	24	2.200	5	241570
			40	8	1.050	2.000 - 2.200	24	2.200	5	241571
				10	1.050	2.000 - 2.200	24	2.200	5	241801
			45	8	1.050	2.000 - 2.200	24	2.200	5	241572
				10	1.050	2.000 - 2.200	24	2.200	5	241802
			50	8	1.050	2.000 - 2.200	24	2.200	5	241573
				10	1.050	2.000 - 2.200	24	2.200	5	241803
			55	8	1.050	2.000 - 2.200	24	2.200	5	241574
				10	1.050	2.000 - 2.200	24	2.200	5	241804

242784

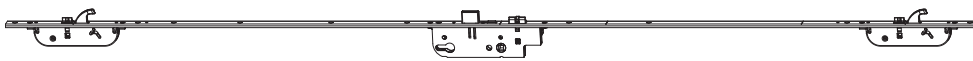







2.2.15 Door lock Z-TA Automatic PT-M with 2 MF-HO E92 U-6x24x6 HH885



modular	silver	92	35	8	885	2.000 - 2.200	24	1.740	5	No
				10	885	2.000 - 2.200	24	1.740	5	242780
			40	8	885	2.000 - 2.200	24	1.740	5	242781
				10	885	2.000 - 2.200	24	1.740	5	242791
			45	8	885	2.000 - 2.200	24	1.740	5	242782
				10	885	2.000 - 2.200	24	1.740	5	242792
			50	8	885	2.000 - 2.200	24	1.740	5	242783
				10	885	2.000 - 2.200	24	1.740	5	242793
			55	8	885	2.000 - 2.200	24	1.740	5	242784







241604

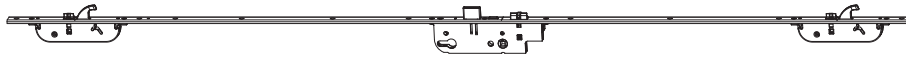

2.2.16 Door lock Z-TA Automatic PT-M with 2 MF-HO E92 U-6x24x6 K+605									No	
modular	silver	92	35	8	1.050	1.800 - 2.000	24	2.200	5	241600
				10	1.050	1.800 - 2.000	24	2.200	5	241810
		40	8	1.050	1.800 - 2.000	24	2.200	5	241601	
				10	1.050	1.800 - 2.000	24	2.200	5	241811
		45	8	1.050	1.800 - 2.000	24	2.200	5	241602	
				10	1.050	1.800 - 2.000	24	2.200	5	241812
		50	8	1.050	1.800 - 2.000	24	2.200	5	241603	
				10	1.050	1.800 - 2.000	24	2.200	5	241813
		55	8	1.050	1.800 - 2.000	24	2.200	5	241604	
				10	1.050	1.800 - 2.000	24	2.200	5	241814







242804



2.2.17 Door lock Z-TA Automatic PT-M with 2 MF-HO E92 U-6x24x6 K+605 HH885									No	
modular	silver	92	35	8	885	1.800 - 2.000	24	1.615	5	242800
				10	885	1.800 - 2.000	24	1.615	5	242810
		40	8	885	1.800 - 2.000	24	1.615	5	242801	
				10	885	1.800 - 2.000	24	1.615	5	242811
		45	8	885	1.800 - 2.000	24	1.615	5	242802	
				10	885	1.800 - 2.000	24	1.615	5	242812
		50	8	885	1.800 - 2.000	24	1.615	5	242803	
				10	885	1.800 - 2.000	24	1.615	5	242813
		55	8	885	1.800 - 2.000	24	1.615	5	242804	
				10	885	1.800 - 2.000	24	1.615	5	242814

241634



2.2.18 Door lock Z-TA Automatic PT-M with 2 MF-HO E92 U-6x24x6 K+980									No	
modular	silver	92	35	8	1.050	2.200 - 2.400	24	2.200	5	241630
				10	1.050	2.200 - 2.400	24	2.200	5	241820
		40	8	1.050	2.200 - 2.400	24	2.200	5	241631	
				10	1.050	2.200 - 2.400	24	2.200	5	241821
		45	8	1.050	2.200 - 2.400	24	2.200	5	241632	
				10	1.050	2.200 - 2.400	24	2.200	5	241822
		50	8	1.050	2.200 - 2.400	24	2.200	5	241633	
				10	1.050	2.200 - 2.400	24	2.200	5	241823
		55	8	1.050	2.200 - 2.400	24	2.200	5	241634	
				10	1.050	2.200 - 2.400	24	2.200	5	241824

242824



2.2.19 Door lock Z-TA Automatic PT-M with 2 MF-HO E92 U-6x24x6 K+980 HH885



modular	silver	92	35	8	885	2.200 - 2.400	24	1.990	5	No
				10	885	2.200 - 2.400	24	1.990	5	242820
			40	8	885	2.200 - 2.400	24	1.990	5	242821
				10	885	2.200 - 2.400	24	1.990	5	242831
			45	8	885	2.200 - 2.400	24	1.990	5	242822
				10	885	2.200 - 2.400	24	1.990	5	242832
			50	8	885	2.200 - 2.400	24	1.990	5	242823
				10	885	2.200 - 2.400	24	1.990	5	242833
			55	8	885	2.200 - 2.400	24	1.990	5	242824
				10	885	2.200 - 2.400	24	1.990	5	242834

Flat faceplate 16 mm

241194



2.2.20 Door lock Z-TA Automatic PT-M with 2 MF-HO E94 F-16



modular	silver	94	35	9	1.050	2.000 - 2.200	16	2.200	5	No
			40	9	1.050	2.000 - 2.200	16	2.200	5	241191
			45	9	1.050	2.000 - 2.200	16	2.200	5	241192
			50	9	1.050	2.000 - 2.200	16	2.200	5	241193
			55	9	1.050	2.000 - 2.200	16	2.200	5	241194
			60	9	1.050	2.000 - 2.200	16	2.200	5	241195
			65	9	1.050	2.000 - 2.200	16	2.200	5	241196
			70	9	1.050	2.000 - 2.200	16	2.200	5	241197
			80	9	1.050	2.000 - 2.200	16	2.200	5	241198

241324









2.2.21 Door lock Z-TA Automatic PT-M with 2 MF-HO E94 F-16 K+605



modular	silver	94	35	9	1.050	1.800 - 2.000	16	2.000	5	No
			40	9	1.050	1.800 - 2.000	16	2.000	5	241321
			45	9	1.050	1.800 - 2.000	16	2.000	5	241322
			50	9	1.050	1.800 - 2.000	16	2.000	5	241323
			55	9	1.050	1.800 - 2.000	16	2.000	5	241324
			60	9	1.050	1.800 - 2.000	16	2.000	5	241325
			65	9	1.050	1.800 - 2.000	16	2.000	5	241326
			70	9	1.050	1.800 - 2.000	16	2.000	5	241327
			80	9	1.050	1.800 - 2.000	16	2.000	5	241328

241454









2.2.22 Door lock Z-TA Automatic PT-M with 2 MF-HO E94 F-16 K+980							L		No	
modular	silver	94	35	9	1.050	2.200 - 2.400	16	2.400	5	241450
			40	9	1.050	2.200 - 2.400	16	2.400	5	241451
			45	9	1.050	2.200 - 2.400	16	2.400	5	241452
			50	9	1.050	2.200 - 2.400	16	2.400	5	241453
			55	9	1.050	2.200 - 2.400	16	2.400	5	241454
			60	9	1.050	2.200 - 2.400	16	2.400	5	241455
			65	9	1.050	2.200 - 2.400	16	2.400	5	241456
			70	9	1.050	2.200 - 2.400	16	2.400	5	241457
			80	9	1.050	2.200 - 2.400	16	2.400	5	241458

Flat faceplate 20 mm







241234

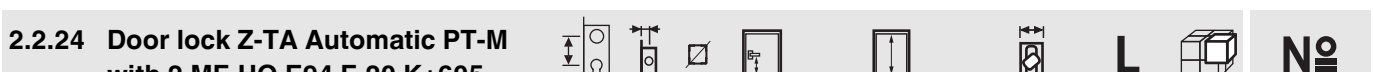

2.2.23 Door lock Z-TA Automatic PT-M with 2 MF-HO E94 F-20							L		No	
modular	silver	94	35	9	1.050	2.000 - 2.200	20	2.200	5	241230
			40	9	1.050	2.000 - 2.200	20	2.200	5	241231
			45	9	1.050	2.000 - 2.200	20	2.200	5	241232
			50	9	1.050	2.000 - 2.200	20	2.200	5	241233
			55	9	1.050	2.000 - 2.200	20	2.200	5	241234
			60	9	1.050	2.000 - 2.200	20	2.200	5	241235
			65	9	1.050	2.000 - 2.200	20	2.200	5	241236
			70	9	1.050	2.000 - 2.200	20	2.200	5	241237
			80	9	1.050	2.000 - 2.200	20	2.200	5	241238

241364



2.2.24 Door lock Z-TA Automatic PT-M with 2 MF-HO E94 F-20 K+605							L		No	
modular	silver	94	35	9	1.050	1.800 - 2.000	20	2.000	5	241360
			40	9	1.050	1.800 - 2.000	20	2.000	5	241361
			45	9	1.050	1.800 - 2.000	20	2.000	5	241362
			50	9	1.050	1.800 - 2.000	20	2.000	5	241363
			55	9	1.050	1.800 - 2.000	20	2.000	5	241364
			60	9	1.050	1.800 - 2.000	20	2.000	5	241365
			65	9	1.050	1.800 - 2.000	20	2.000	5	241366
			70	9	1.050	1.800 - 2.000	20	2.000	5	241367
			80	9	1.050	1.800 - 2.000	20	2.000	5	241368

241494



2.2.25 Door lock Z-TA Automatic PT-M with 2 MF-HO E94 F-20 K+980



modular	silver	94	35	9	1.050	2.200 - 2.400	20	2.400	5	№
			40	9	1.050	2.200 - 2.400	20	2.400	5	241490
			45	9	1.050	2.200 - 2.400	20	2.400	5	241491
			50	9	1.050	2.200 - 2.400	20	2.400	5	241492
			55	9	1.050	2.200 - 2.400	20	2.400	5	241493
			60	9	1.050	2.200 - 2.400	20	2.400	5	241494
			65	9	1.050	2.200 - 2.400	20	2.400	5	241495
			70	9	1.050	2.200 - 2.400	20	2.400	5	241496
			80	9	1.050	2.200 - 2.400	20	2.400	5	241497
										241498

Flat faceplate 24 mm

241264

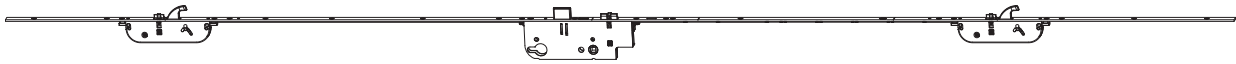

2.2.26 Door lock Z-TA Automatic PT-M with 2 MF-HO E94 F-24



modular	silver	94	35	9	1.050	2.000 - 2.200	24	2.200	5	№
			40	9	1.050	2.000 - 2.200	24	2.200	5	241260
			45	9	1.050	2.000 - 2.200	24	2.200	5	241261
			50	9	1.050	2.000 - 2.200	24	2.200	5	241262
			55	9	1.050	2.000 - 2.200	24	2.200	5	241263
			60	9	1.050	2.000 - 2.200	24	2.200	5	241264
			65	9	1.050	2.000 - 2.200	24	2.200	5	241265
			70	9	1.050	2.000 - 2.200	24	2.200	5	241266
			80	9	1.050	2.000 - 2.200	24	2.200	5	241267
										241268

241394

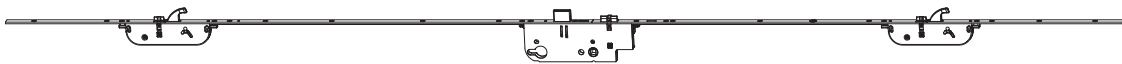







2.2.27 Door lock Z-TA Automatic PT-M with 2 MF-HO E94 F-24 K+605



modular	silver	94	35	9	1.050	1.800 - 2.000	24	2.000	5	№
			40	9	1.050	1.800 - 2.000	24	2.000	5	241390
			45	9	1.050	1.800 - 2.000	24	2.000	5	241391
			50	9	1.050	1.800 - 2.000	24	2.000	5	241392
			55	9	1.050	1.800 - 2.000	24	2.000	5	241393
			60	9	1.050	1.800 - 2.000	24	2.000	5	241394
			65	9	1.050	1.800 - 2.000	24	2.000	5	241395
			70	9	1.050	1.800 - 2.000	24	2.000	5	241396
			80	9	1.050	1.800 - 2.000	24	2.000	5	241397
										241398

241524









2.2.28 Door lock Z-TA Automatic PT-M with 2 MF-HO E94 F-24 K+980							L		No	
modular	silver	94	35	9	1.050	2.200 - 2.400	24	2.400	5	241520
			40	9	1.050	2.200 - 2.400	24	2.400	5	241521
			45	9	1.050	2.200 - 2.400	24	2.400	5	241522
			50	9	1.050	2.200 - 2.400	24	2.400	5	241523
			55	9	1.050	2.200 - 2.400	24	2.400	5	241524
			60	9	1.050	2.200 - 2.400	24	2.400	5	241525
			65	9	1.050	2.000 - 2.400	24	2.400	5	241526
			70	9	1.050	2.000 - 2.400	24	2.400	5	241527
			80	9	1.050	2.200 - 2.400	24	2.400	5	241528

Top hat faceplate 24/16 mm







241294

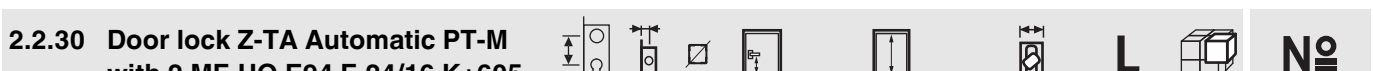

2.2.29 Door lock Z-TA Automatic PT-M with 2 MF-HO E94 F-24/16 top-hat faceplate							L		No	
modular	silver	94	35	9	1.050	2.000 - 2.200	24/16	2.200	5	241290
			40	9	1.050	2.000 - 2.200	24/16	2.200	5	241291
			45	9	1.050	2.000 - 2.200	24/16	2.200	5	241292
			50	9	1.050	2.000 - 2.200	24/16	2.200	5	241293
			55	9	1.050	2.000 - 2.200	24/16	2.200	5	241294
			60	9	1.050	2.000 - 2.200	24/16	2.200	5	241295
			65	9	1.050	2.000 - 2.200	24/16	2.200	5	241296
			70	9	1.050	2.000 - 2.200	24/16	2.200	5	241297
			80	9	1.050	2.000 - 2.200	24/16	2.200	5	241298

241424



2.2.30 Door lock Z-TA Automatic PT-M with 2 MF-HO E94 F-24/16 K+605							L		No	
modular	silver	94	35	9	1.050	1.800 - 2.000	24/16	2.000	5	241420
			40	9	1.050	1.800 - 2.000	24/16	2.000	5	241421
			45	9	1.050	1.800 - 2.000	24/16	2.000	5	241422
			50	9	1.050	1.800 - 2.000	24/16	2.000	5	241423
			55	9	1.050	1.800 - 2.000	24/16	2.000	5	241424
			60	9	1.050	1.800 - 2.000	24/16	2.000	5	241425
			65	9	1.050	1.800 - 2.000	24/16	2.000	5	241426
			70	9	1.050	1.800 - 2.000	24/16	2.000	5	241427
			80	9	1.050	1.800 - 2.000	24/16	2.000	5	241428

241554



2.2.31 Door lock Z-TA Automatic PT-M with 2 MF-HO E94 F-24/16 K+980							L		№	
modular	silver	94	35	9	1.050	2.200 - 2.400	24/16	2.400	5	241550
			40	9	1.050	2.200 - 2.400	24/16	2.400	5	241551
			45	9	1.050	2.200 - 2.400	24/16	2.400	5	241552
			50	9	1.050	2.200 - 2.400	24/16	2.400	5	241553
			55	9	1.050	2.200 - 2.400	24/16	2.400	5	241554
			60	9	1.050	2.200 - 2.400	24/16	2.400	5	241555
			65	9	1.050	2.200 - 2.400	24/16	2.400	5	241556
			70	9	1.050	2.200 - 2.400	24/16	2.400	5	241557
			80	9	1.050	2.200 - 2.400	24/16	2.400	5	241558

U-faceplate 6x24x6 mm

241584



2.2.32 Door lock Z-TA Automatic PT-M with 2 MF-HO E94 U-6x24x6							L		№	
modular	silver	94	35	9	1.050	2.000 - 2.200	24	2.200	5	241580
			40	9	1.050	2.000 - 2.200	24	2.200	5	241581
			45	9	1.050	2.000 - 2.200	24	2.200	5	241582
			50	9	1.050	2.000 - 2.200	24	2.200	5	241583
			55	9	1.050	2.000 - 2.200	24	2.200	5	241584

241614



2.2.33 Door lock Z-TA Automatic PT-M with 2 MF-HO E94 U-6x24x6 K+605							L		№	
modular	silver	94	35	9	1.050	1.800 - 2.000	24	2.200	5	241610
			40	9	1.050	1.800 - 2.000	24	2.200	5	241611
			45	9	1.050	1.800 - 2.000	24	2.200	5	241612
			50	9	1.050	1.800 - 2.000	24	2.200	5	241613
			55	9	1.050	1.800 - 2.000	24	2.200	5	241614

241644



2.2.34 Door lock Z-TA Automatic PT-M with 2 MF-HO E94 U-6x24x6 K+980							L		№	
modular	silver	94	35	9	1.050	2.200 - 2.400	24	2.200	5	241640
			40	9	1.050	2.200 - 2.400	24	2.200	5	241641
			45	9	1.050	2.200 - 2.400	24	2.200	5	241642
			50	9	1.050	2.200 - 2.400	24	2.200	5	241643
			55	9	1.050	2.200 - 2.400	24	2.200	5	241644

**MACO
PROTECT**



Z-TA – Automatic Door Lock Triple Latch



3 Z-TF Triple Latch Door Lock

3.1	Hardware overview Z-TF	34
3.1.1	Z-TF i.S. PT	34
3.1.2	Z-TF i.S. PT RC2	37
3.1.3	Z-TF MF-BO PT	41
3.2	Door lock Z-TF with MF + i.S.	44
3.2.1	Door lock Z-TF with 2 MF + 2 i.S.	44
3.2.2	Door lock Z-TF PT with 2 MF + 4i.S.	52
3.3	Door lock Z-TF PT with MF-BO	57
3.3.1	Door lock Z-TF PT with 2 MF-BO	57

3 Z-TF Triple Latch Door Lock

3.1 Hardware overview Z-TF

3.1.1 Z-TF i.S. PT



2 MF + 2 i.S.
1- & 2-sashed

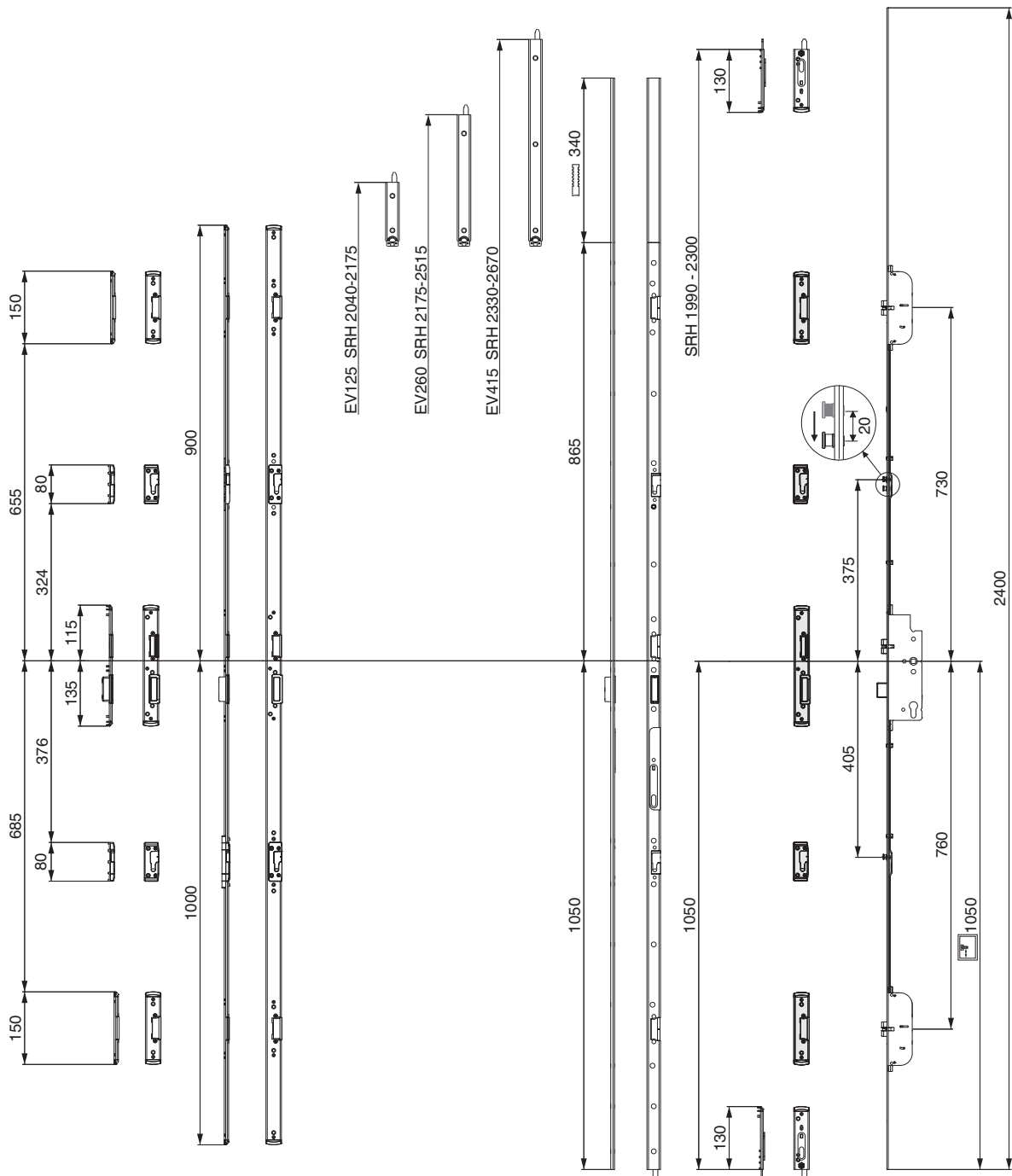



2 MF + 2 i.S. K+500

1- & 2-sashed

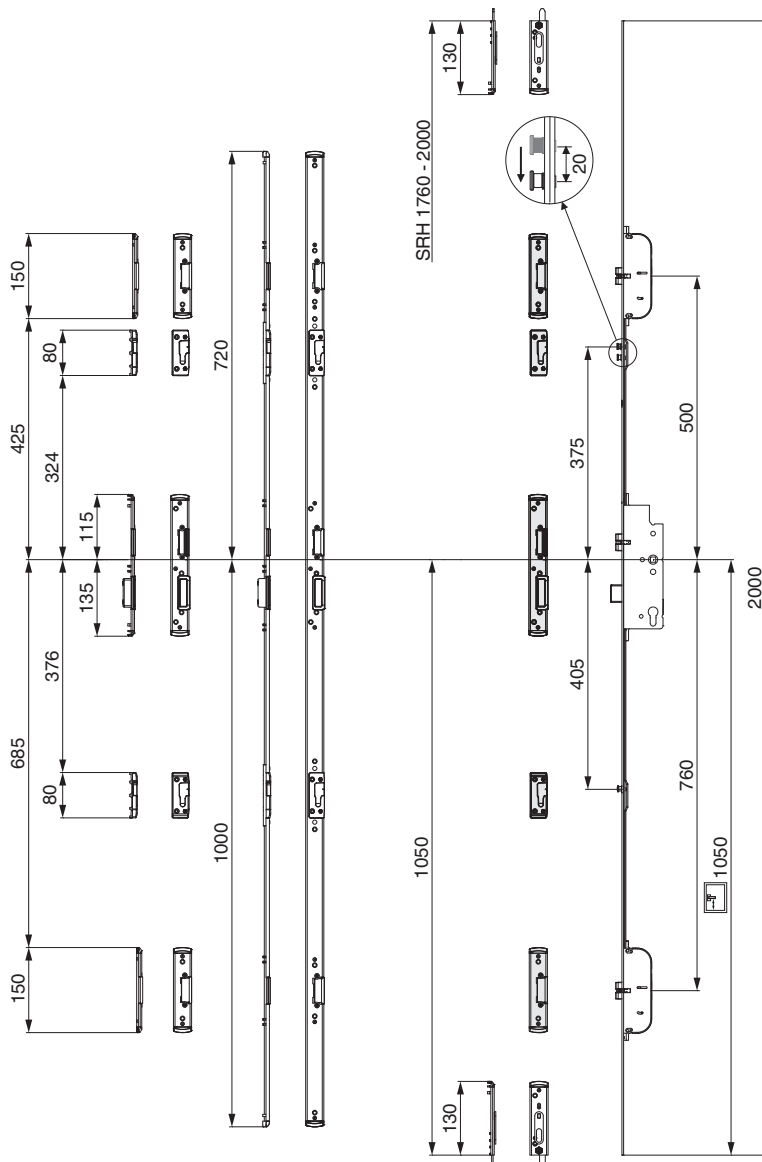



2 MF + 3 i.S. K+1300

1- & 2-sashed

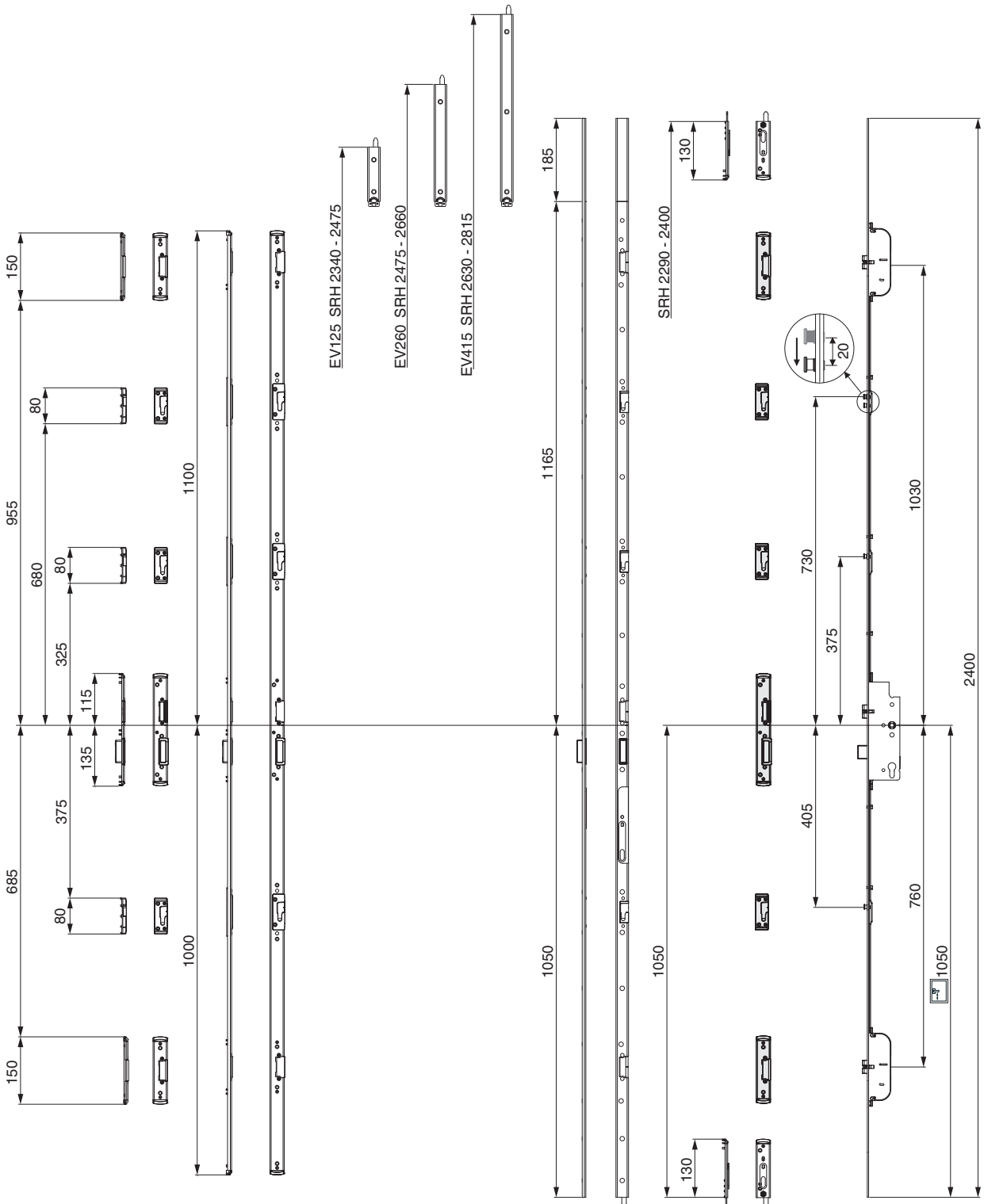

3.1.2 Z-TF i.S. PT RC2



2 MF + 4 i.S.

with end piece 300 mm*

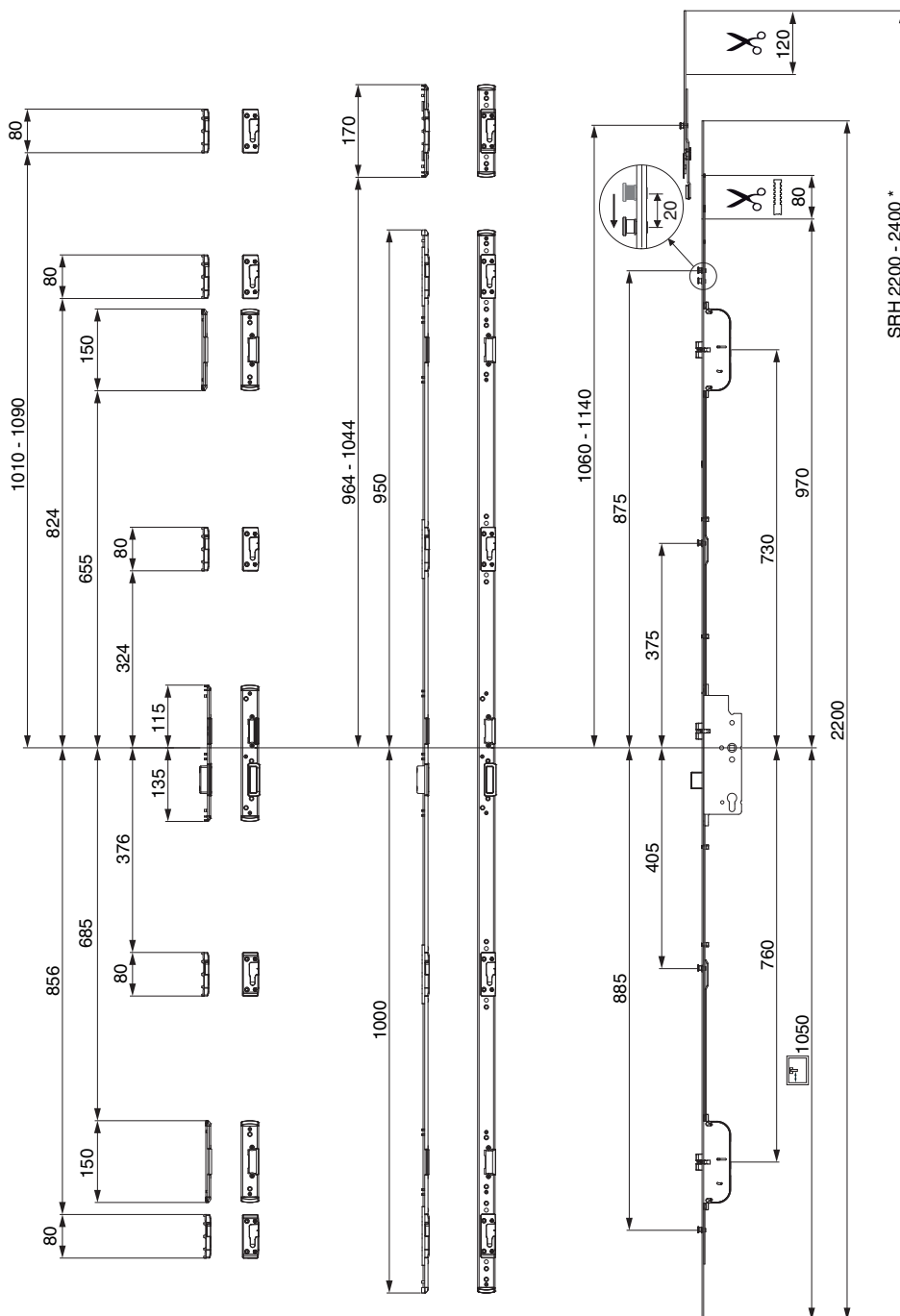



2 MF + 4 i.S.

with end piece 500 mm*

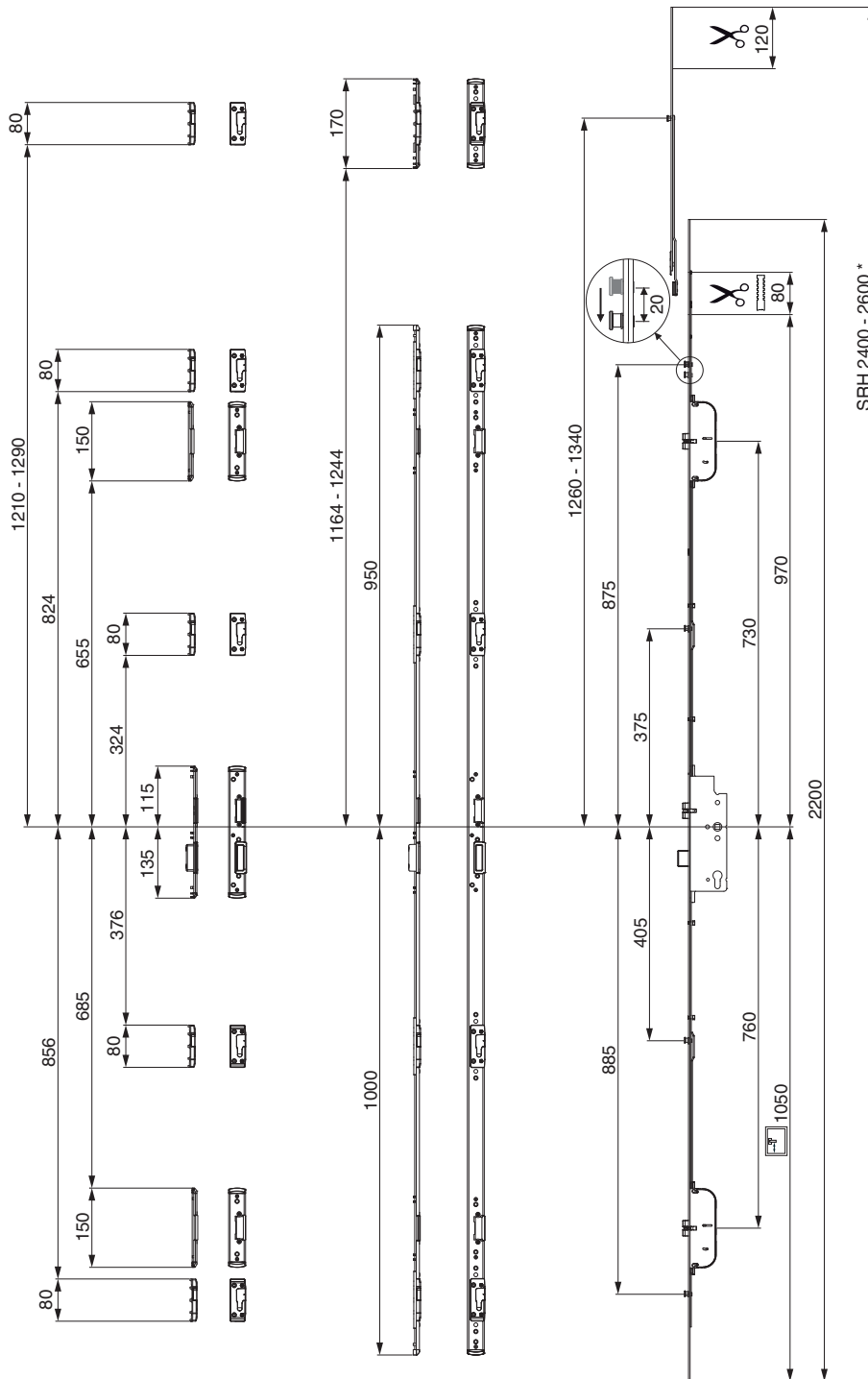



2 MF + 4 i.S. K+500

with end piece 300 mm*

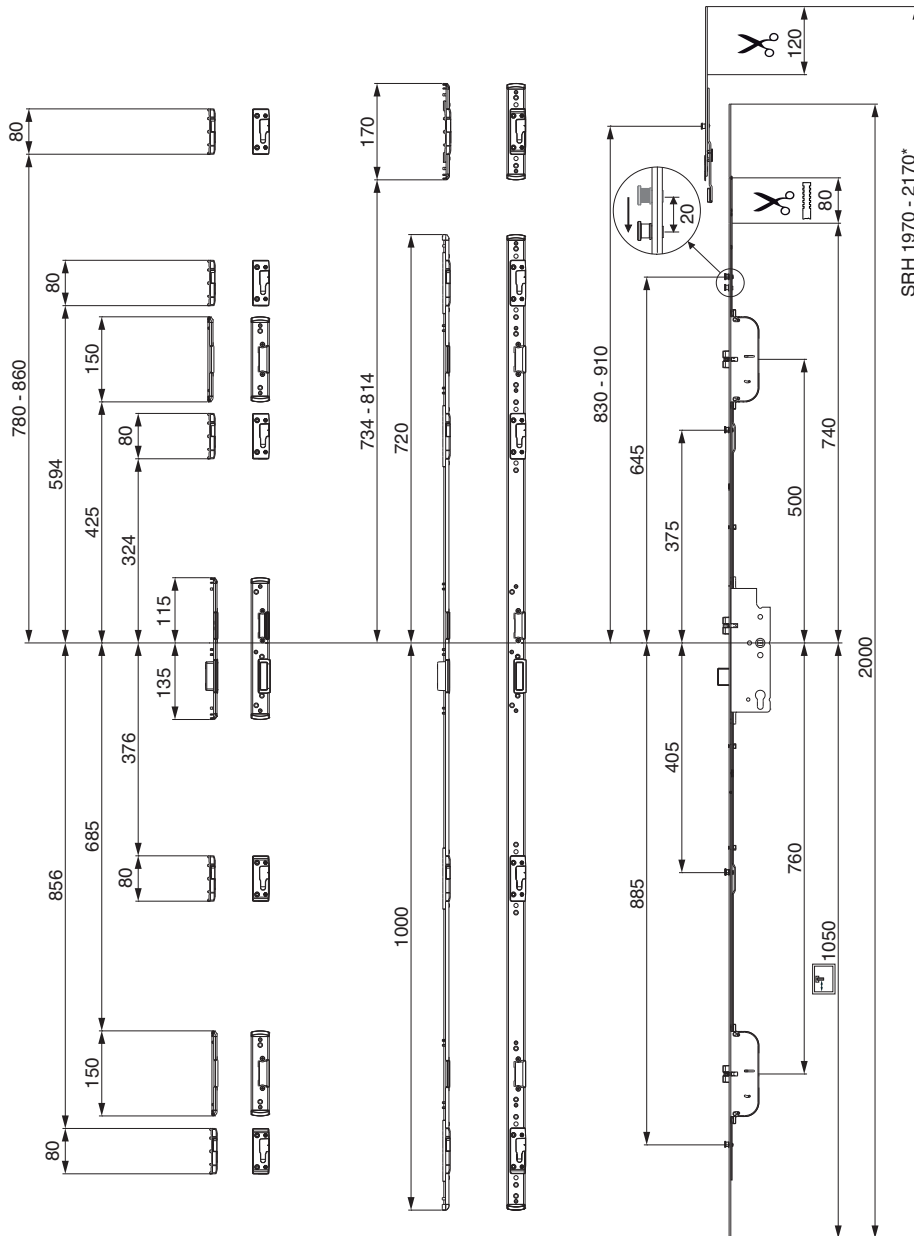



2 MF + 4 i.S. K+500
with end piece 500 mm*

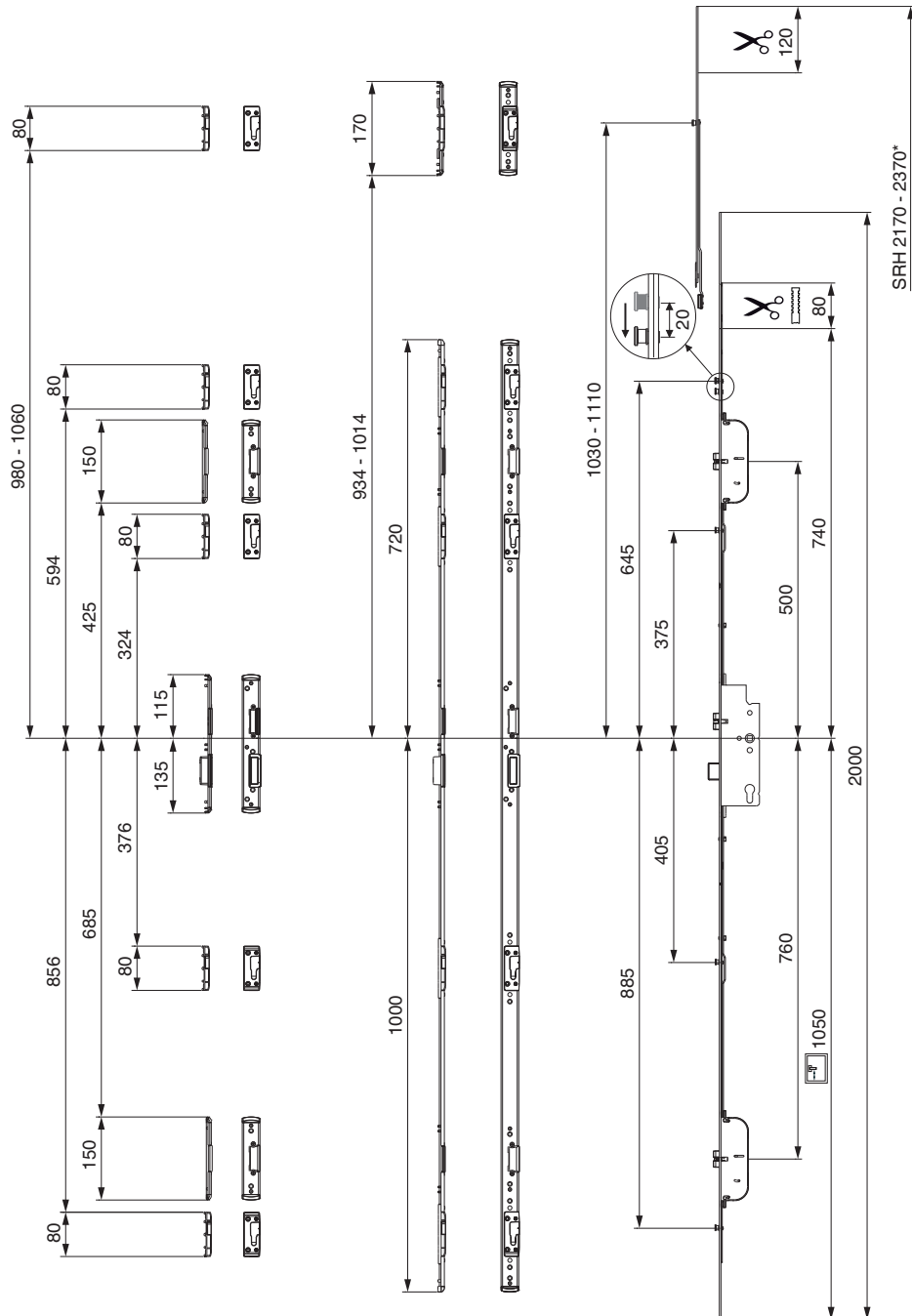



3.1.3 Z-TF MF-BO PT



2 MF-BO
1- & 2-sashed

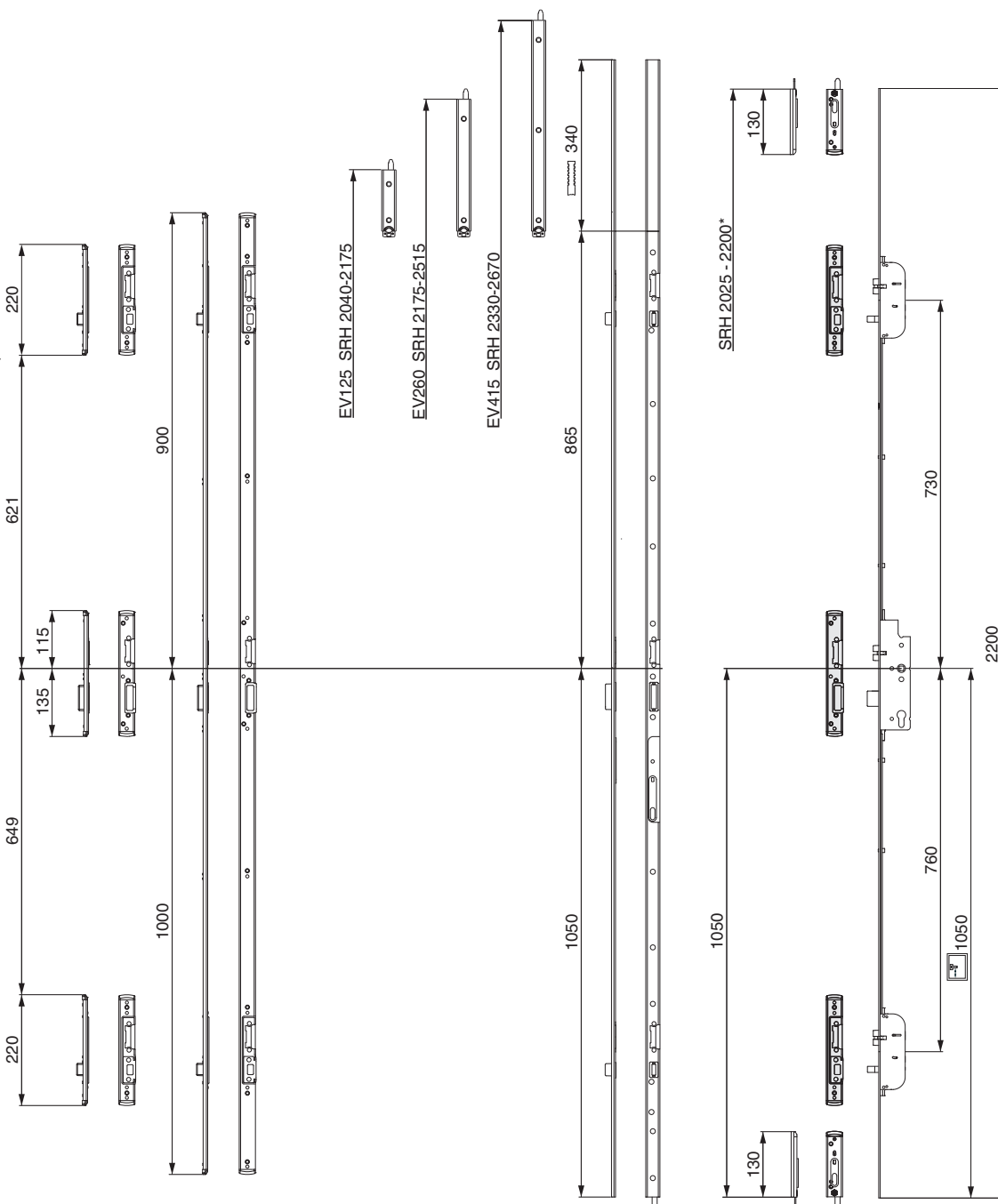



2 MF-BO K+605

1- & 2-sashed

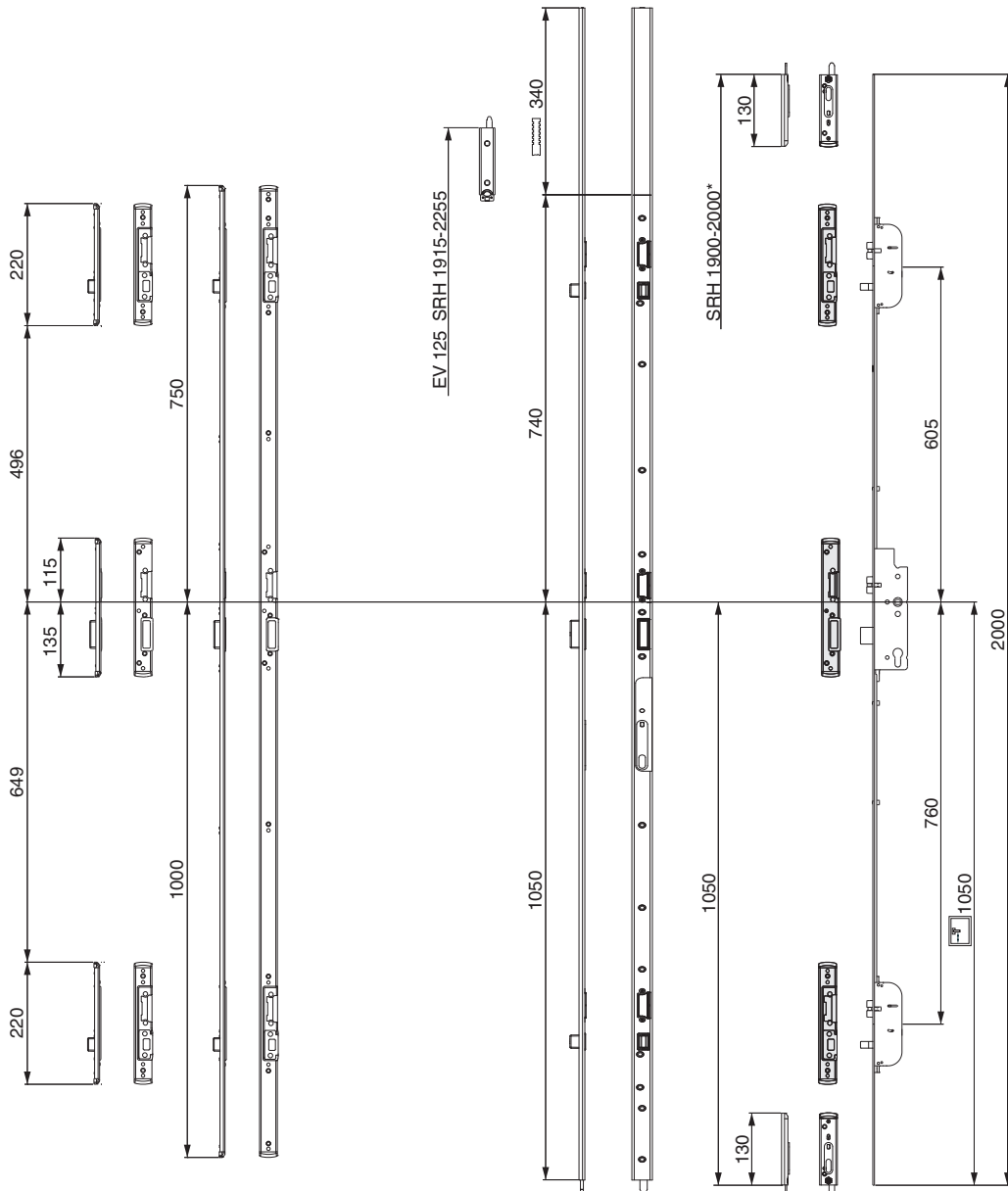



2 MF-BO K+980

1- & 2-sashed

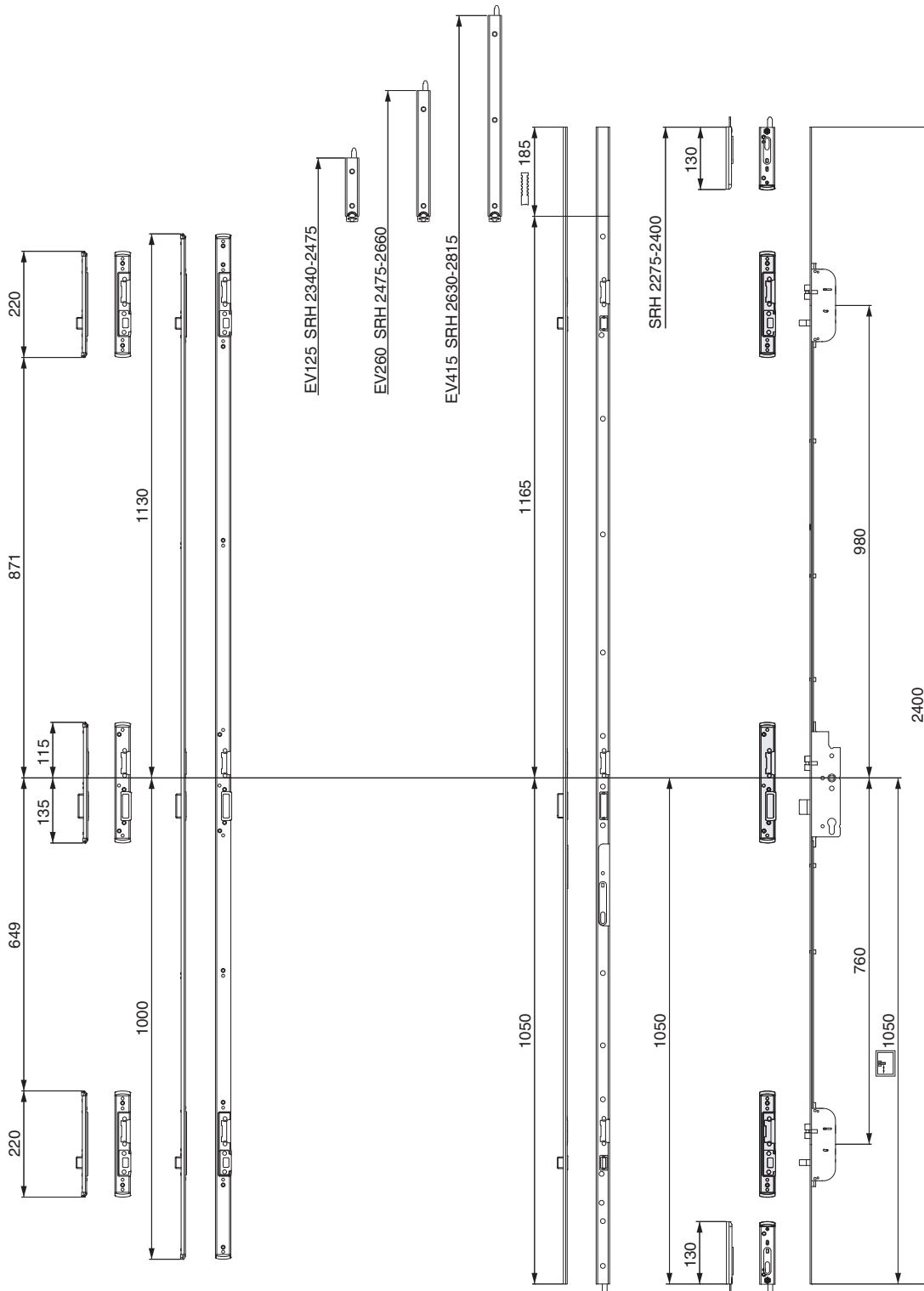

3.2 Door lock Z-TF with MF + i.S.











3.2.1 Door lock Z-TF with 2 MF + 2 i.S.

Flat faceplate 16 mm

235774













3.2.1.1 Door lock Z-TF PT with 2 MF + 2i.S. E92 F-16

											
		L			No						
fixed handle height	silver	92	35	8	1.050	1.950 - 2.400	16	2.400	5	235770	
				10	1.050	1.950 - 2.400	16	2.400	5	235780	
			40	8	1.050	1.950 - 2.400	16	2.400	5	235771	
				10	1.050	1.950 - 2.400	16	2.400	5	235781	
			45	8	1.050	1.950 - 2.400	16	2.400	5	235772	
				10	1.050	1.950 - 2.400	16	2.400	5	235782	
			50	8	1.050	1.950 - 2.400	16	2.400	5	235773	
				10	1.050	1.950 - 2.400	16	2.400	5	235783	
			55	8	1.050	1.950 - 2.400	16	2.400	5	235774	
				10	1.050	1.950 - 2.400	16	2.400	5	235784	
			65	8	1.050	1.950 - 2.400	16	2.400	5	235775	
				10	1.050	1.950 - 2.400	16	2.400	5	235785	
			70	8	1.050	1.950 - 2.400	16	2.400	5	235776	
				10	1.050	1.950 - 2.400	16	2.400	5	235786	
			80	8	1.050	1.950 - 2.400	16	2.400	5	235777	
				10	1.050	1.950 - 2.400	16	2.400	5	235787	

237854



3.2.1.2 Door lock Z-TF PT with 2 MF + 2i.S. E92 F-16 K+500

											
		L			No						
fixed handle height	silver	92	35	8	1.050	1.700 - 2.000	16	2.000	5	237850	
				10	1.050	1.700 - 2.000	16	2.000	5	237870	
			40	8	1.050	1.700 - 2.000	16	2.000	5	237851	
				10	1.050	1.700 - 2.000	16	2.000	5	237871	
			45	8	1.050	1.700 - 2.000	16	2.000	5	237852	
				10	1.050	1.700 - 2.000	16	2.000	5	237872	
			50	8	1.050	1.700 - 2.000	16	2.000	5	237853	
				10	1.050	1.700 - 2.000	16	2.000	5	237873	
			55	8	1.050	1.700 - 2.000	16	2.000	5	237854	
				10	1.050	1.700 - 2.000	16	2.000	5	237874	
			65	8	1.050	1.700 - 2.000	16	2.000	5	237855	
				10	1.050	1.700 - 2.000	16	2.000	5	237875	
			70	8	1.050	1.700 - 2.000	16	2.000	5	237856	
				10	1.050	1.700 - 2.000	16	2.000	5	237876	
			80	8	1.050	1.700 - 2.000	16	2.000	5	237857	
				10	1.050	1.700 - 2.000	16	2.000	5	237877	

234774



**3.2.1.3 Door lock Z-TF PT
with 2 MF + 3i.S. E92 F-16 K+1030**



fixed handle height	silver	92	35	8	1.050	2.250 - 2.400	16	2.400	5	No
				10	1.050	2.250 - 2.400	16	2.400	5	234770
			40	8	1.050	2.250 - 2.400	16	2.400	5	234771
				10	1.050	2.250 - 2.400	16	2.400	5	234201
			45	8	1.050	2.250 - 2.400	16	2.400	5	234772
				10	1.050	2.250 - 2.400	16	2.400	5	234202
			50	8	1.050	2.250 - 2.400	16	2.400	5	234773
				10	1.050	2.250 - 2.400	16	2.400	5	234203
			55	8	1.050	2.250 - 2.400	16	2.400	5	234774
				10	1.050	2.250 - 2.400	16	2.400	5	234204
			65	8	1.050	2.250 - 2.400	16	2.400	5	234775
				10	1.050	2.250 - 2.400	16	2.400	5	234205
			70	8	1.050	2.250 - 2.400	16	2.400	5	234776
				10	1.050	2.250 - 2.400	16	2.400	5	234206
			80	8	1.050	2.250 - 2.400	16	2.400	5	234777
				10	1.050	2.250 - 2.400	16	2.400	5	234207

Flat faceplate 20 mm

235344









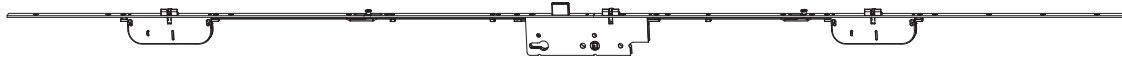

**3.2.1.4 Door lock Z-TF PT
with 2 MF + 2i.S. E92 F-20**



fixed handle height	silver	92	35	8	1.050	1.950 - 2.400	20	2.400	5	No
				10	1.050	1.950 - 2.400	20	2.400	5	235340
			40	8	1.050	1.950 - 2.400	20	2.400	5	235341
				10	1.050	1.950 - 2.400	20	2.400	5	235351
			45	8	1.050	1.950 - 2.400	20	2.400	5	235342
				10	1.050	1.950 - 2.400	20	2.400	5	235352
			50	8	1.050	1.950 - 2.400	20	2.400	5	235343
				10	1.050	1.950 - 2.400	20	2.400	5	235353
			55	8	1.050	1.950 - 2.400	20	2.400	5	235344
				10	1.050	1.950 - 2.400	20	2.400	5	235354
			65	8	1.050	1.950 - 2.400	20	2.400	5	235345
				10	1.050	1.950 - 2.400	20	2.400	5	235355
			70	8	1.050	1.950 - 2.400	20	2.400	5	235346
				10	1.050	1.950 - 2.400	20	2.400	5	235356
			80	8	1.050	1.950 - 2.400	20	2.400	5	235347
				10	1.050	1.950 - 2.400	20	2.400	5	235357







238034



3.2.1.5 Door lock Z-TF PT with 2 MF + 2i.S. E92 F-20 K+500								L		No
fixed handle height	silver	92	35	8	1.050	1.700 - 2.000	20	2.000	5	238030
				10	1.050	1.700 - 2.000	20	2.000	5	238050
		40	8	1.050	1.700 - 2.000	20	2.000	5	238031	
			10	1.050	1.700 - 2.000	20	2.000	5	238051	
		45	8	1.050	1.700 - 2.000	20	2.000	5	238032	
			10	1.050	1.700 - 2.000	20	2.000	5	238052	
		50	8	1.050	1.700 - 2.000	20	2.000	5	238033	
			10	1.050	1.700 - 2.000	20	2.000	5	238053	
		55	8	1.050	1.700 - 2.000	20	2.000	5	238034	
			10	1.050	1.700 - 2.000	20	2.000	5	238054	
		65	8	1.050	1.700 - 2.000	20	2.000	5	238035	
			10	1.050	1.700 - 2.000	20	2.000	5	238055	
		70	8	1.050	1.700 - 2.000	20	2.000	5	238036	
			10	1.050	1.700 - 2.000	20	2.000	5	238056	
		80	8	1.050	1.700 - 2.000	20	2.000	5	238037	
			10	1.050	1.700 - 2.000	20	2.000	5	238057	

234794









3.2.1.6 Door lock Z-TF PT with 2 MF + 3i.S. E92 F-20 K+1030								L		No
fixed handle height	silver	92	35	8	1.050	2.250 - 2.400	20	2.400	5	234790
				10	1.050	2.250 - 2.400	20	2.400	5	234230
		40	8	1.050	2.250 - 2.400	20	2.400	5	234791	
			10	1.050	2.250 - 2.400	20	2.400	5	234231	
		45	8	1.050	2.250 - 2.400	20	2.400	5	234792	
			10	1.050	2.250 - 2.400	20	2.400	5	234232	
		50	8	1.050	2.250 - 2.400	20	2.400	5	234793	
			10	1.050	2.250 - 2.400	20	2.400	5	234233	
		55	8	1.050	2.250 - 2.400	20	2.400	5	234794	
			10	1.050	2.250 - 2.400	20	2.400	5	234234	
		65	8	1.050	2.250 - 2.400	20	2.400	5	234795	
			10	1.050	2.250 - 2.400	20	2.400	5	234235	
		70	8	1.050	2.250 - 2.400	20	2.400	5	234796	
			10	1.050	2.250 - 2.400	20	2.400	5	234236	
		80	8	1.050	2.250 - 2.400	20	2.400	5	234797	
			10	1.050	2.250 - 2.400	20	2.400	5	234237	

Flat faceplate 24 mm

235374



**3.2.1.7 Door lock Z-TF PT
with 2 MF + 2i.S. E92 F-24**







								L		No
fixed handle height	silver	92	35	8	1.050	1.950 - 2.400	24	2.400	5	235370
				10	1.050	1.950 - 2.400	24	2.400	5	235380
			40	8	1.050	1.950 - 2.400	24	2.400	5	235371
				10	1.050	1.950 - 2.400	24	2.400	5	235381
			45	8	1.050	1.950 - 2.400	24	2.400	5	235372
				10	1.050	1.950 - 2.400	24	2.400	5	235382
			50	8	1.050	1.950 - 2.400	24	2.400	5	235373
				10	1.050	1.950 - 2.400	24	2.400	5	235383
			55	8	1.050	1.950 - 2.400	24	2.400	5	235374
				10	1.050	1.950 - 2.400	24	2.400	5	235384
			65	8	1.050	1.950 - 2.400	24	2.400	5	235375
				10	1.050	1.950 - 2.400	24	2.400	5	235385
			70	8	1.050	1.950 - 2.400	24	2.400	5	235376
				10	1.050	1.950 - 2.400	24	2.400	5	235386
			80	8	1.050	1.950 - 2.400	24	2.400	5	235377
				10	1.050	1.950 - 2.400	24	2.400	5	235387

Top hat faceplate 24/16 mm

237654









**3.2.1.8 Door lock Z-TF PT
with 2 MF + 2i.S. E92 F-24/16**

								L		No
fixed handle height	silver	92	35	8	1.050	1.950 - 2.400	24/16	2.400	5	237650
				10	1.050	1.950 - 2.400	24/16	2.400	5	237660
			40	8	1.050	1.950 - 2.400	24/16	2.400	5	237651
				10	1.050	1.950 - 2.400	24/16	2.400	5	237661
			45	8	1.050	1.950 - 2.400	24/16	2.400	5	237652
				10	1.050	1.950 - 2.400	24/16	2.400	5	237662
			50	8	1.050	1.950 - 2.400	24/16	2.400	5	237653
				10	1.050	1.950 - 2.400	24/16	2.400	5	237663
			55	8	1.050	1.950 - 2.400	24/16	2.400	5	237654
				10	1.050	1.950 - 2.400	24/16	2.400	5	237664
			65	8	1.050	1.950 - 2.400	24/16	2.400	5	237655
				10	1.050	1.950 - 2.400	24/16	2.400	5	237665
			70	8	1.050	1.950 - 2.400	24/16	2.400	5	237656
				10	1.050	1.950 - 2.400	24/16	2.400	5	237666
			80	8	1.050	1.950 - 2.400	24/16	2.400	5	237657
				10	1.050	1.950 - 2.400	24/16	2.400	5	237667







238214



3.2.1.9 Door lock Z-TF PT with 2 MF + 2i.S. E92 F-24/16 K+500								L		No
fixed handle height	silver	92	35	8	1.050	1.700 - 2.000	24/16	2.000	5	238210
				10	1.050	1.700 - 2.000	24/16	2.000	5	238230
			40	8	1.050	1.700 - 2.000	24/16	2.000	5	238211
				10	1.050	1.700 - 2.000	24/16	2.000	5	238231
			45	8	1.050	1.700 - 2.000	24/16	2.000	5	238212
				10	1.050	1.700 - 2.000	24/16	2.000	5	238232
			50	8	1.050	1.700 - 2.000	24/16	2.000	5	238213
				10	1.050	1.700 - 2.000	24/16	2.000	5	238233
			55	8	1.050	1.700 - 2.000	24/16	2.000	5	238214
				10	1.050	1.700 - 2.000	24/16	2.000	5	238234
			65	8	1.050	1.700 - 2.000	24/16	2.000	5	238215
				10	1.050	1.700 - 2.000	24/16	2.000	5	238235
			70	8	1.050	1.700 - 2.000	24/16	2.000	5	238216
				10	1.050	1.700 - 2.000	24/16	2.000	5	238236
			80	8	1.050	1.700 - 2.000	24/16	2.000	5	238217
				10	1.050	1.700 - 2.000	24/16	2.000	5	238237

237684



3.2.1.10 Door lock Z-TF PT with 2 MF + 3i.S. E92 F-24/16 K+1030								L		No
fixed handle height	silver	92	35	8	1.050	2.250 - 2.400	24/16	2.400	5	237680
				10	1.050	2.250 - 2.400	24/16	2.400	5	237690
			40	8	1.050	2.250 - 2.400	24/16	2.400	5	237681
				10	1.050	2.250 - 2.400	24/16	2.400	5	237691
			45	8	1.050	2.250 - 2.400	24/16	2.400	5	237682
				10	1.050	2.250 - 2.400	24/16	2.400	5	237692
			50	8	1.050	2.250 - 2.400	24/16	2.400	5	237683
				10	1.050	2.250 - 2.400	24/16	2.400	5	237693
			55	8	1.050	2.250 - 2.400	24/16	2.400	5	237684
				10	1.050	2.250 - 2.400	24/16	2.400	5	237694
			65	8	1.050	2.250 - 2.400	24/16	2.400	5	237685
				10	1.050	2.250 - 2.400	24/16	2.400	5	237695
			70	8	1.050	2.250 - 2.400	24/16	2.400	5	237686
				10	1.050	2.250 - 2.400	24/16	2.400	5	237696
			80	8	1.050	2.250 - 2.400	24/16	2.400	5	237687
				10	1.050	2.250 - 2.400	24/16	2.400	5	237697

Flat faceplate 16 mm

234284



**3.2.1.11 Door lock Z-TF PT
with 2 MF + 2i.S. E94 F-16**



fixed handle height	silver	94	35	9	1.050	1.950 - 2.400	16	2.400	5	No
			40	9	1.050	1.950 - 2.400	16	2.400	5	234280
			45	9	1.050	1.950 - 2.400	16	2.400	5	234281
			50	9	1.050	1.950 - 2.400	16	2.400	5	234282
			55	9	1.050	1.950 - 2.400	16	2.400	5	234283
			65	9	1.050	1.950 - 2.400	16	2.400	5	234284
			70	9	1.050	1.950 - 2.400	16	2.400	5	234285
			80	9	1.050	1.950 - 2.400	16	2.400	5	234286
										234287

237884



**3.2.1.12 Door lock Z-TF PT
with 2 MF + 2i.S. E94 F-16 K+500**



fixed handle height	silver	94	35	9	1.050	1.700 - 2.000	16	2.000	5	No
			40	9	1.050	1.700 - 2.000	16	2.000	5	237880
			45	9	1.050	1.700 - 2.000	16	2.000	5	237881
			50	9	1.050	1.700 - 2.000	16	2.000	5	237882
			55	9	1.050	1.700 - 2.000	16	2.000	5	237883
			65	9	1.050	1.700 - 2.000	16	2.000	5	237884
			70	9	1.050	1.700 - 2.000	16	2.000	5	237885
			80	9	1.050	1.700 - 2.000	16	2.000	5	237886
										237887

234224



**3.2.1.13 Door lock Z-TF PT
with 2 MF + 3i.S. E94 F-16 K+1030**









fixed handle height	silver	94	35	9	1.050	2.250 - 2.400	16	2.400	5	No
			40	9	1.050	2.250 - 2.400	16	2.400	5	234220
			45	9	1.050	2.250 - 2.400	16	2.400	5	234221
			50	9	1.050	2.250 - 2.400	16	2.400	5	234222
			55	9	1.050	2.250 - 2.400	16	2.400	5	234223
			65	9	1.050	2.250 - 2.400	16	2.400	5	234224
			70	9	1.050	2.250 - 2.400	16	2.400	5	234225
			80	9	1.050	2.250 - 2.400	16	2.400	5	234226
										234227

Flat faceplate 20 mm

234634









**3.2.1.14 Door lock Z-TF PT
with 2 MF + 2i.S. E94 F-20**

								L		No
fixed handle height	silver	94	35	9	1.050	1.950 - 2.400	20	2.400	5	234630
			40	9	1.050	1.950 - 2.400	20	2.400	5	234631
			45	9	1.050	1.950 - 2.400	20	2.400	5	234632
			50	9	1.050	1.950 - 2.400	20	2.400	5	234633
			55	9	1.050	1.950 - 2.400	20	2.400	5	234634
			65	9	1.050	1.950 - 2.400	20	2.400	5	234635
			70	9	1.050	1.950 - 2.400	20	2.400	5	234636
			80	9	1.050	1.950 - 2.400	20	2.400	5	234637

238064









**3.2.1.15 Door lock Z-TF PT
with 2 MF + 2i.S. E94 F-20 K+500**

								L		No
fixed handle height	silver	94	35	9	1.050	1.700 - 2.000	20	2.000	5	238060
			40	9	1.050	1.700 - 2.000	20	2.000	5	238061
			45	9	1.050	1.700 - 2.000	20	2.000	5	238062
			50	9	1.050	1.700 - 2.000	20	2.000	5	238063
			55	9	1.050	1.700 - 2.000	20	2.000	5	238064
			65	9	1.050	1.700 - 2.000	20	2.000	5	238065
			70	9	1.050	1.700 - 2.000	20	2.000	5	238066
			80	9	1.050	1.700 - 2.000	20	2.000	5	238067

234254



**3.2.1.16 Door lock Z-TF PT
with 2 MF + 3i.S. E94 F-20 K+1030**

								L		No
fixed handle height	silver	94	35	9	1.050	2.250 - 2.400	20	2.400	5	234250
			40	9	1.050	2.250 - 2.400	20	2.400	5	234251
			45	9	1.050	2.250 - 2.400	20	2.400	5	234252
			50	9	1.050	2.250 - 2.400	20	2.400	5	234253
			55	9	1.050	2.250 - 2.400	20	2.400	5	234254
			65	9	1.050	2.250 - 2.400	20	2.400	5	234255
			70	9	1.050	2.250 - 2.400	20	2.400	5	234256
			80	9	1.050	2.250 - 2.400	20	2.400	5	234257

Top hat faceplate 24/16 mm

238374



**3.2.1.17 Door lock Z-TF PT
with 2 MF + 2i.S. E94 F-24/16**



fixed handle height	silver	94	35	9	1.050	1.950 - 2.400	24/16	2.400	5	No
			40	9	1.050	1.950 - 2.400	24/16	2.400	5	238370
			45	9	1.050	1.950 - 2.400	24/16	2.400	5	238371
			50	9	1.050	1.950 - 2.400	24/16	2.400	5	238372
			55	9	1.050	1.950 - 2.400	24/16	2.400	5	238373
			65	9	1.050	1.950 - 2.400	24/16	2.400	5	238374
			70	9	1.050	1.950 - 2.400	24/16	2.400	5	238375
			80	9	1.050	1.950 - 2.400	24/16	2.400	5	238376
										238377

3

238244



**3.2.1.18 Door lock Z-TF PT
with 2 MF + 2i.S. E94 F-24/16 K+500**



fixed handle height	silver	94	35	9	1.050	1.700 - 2.000	24/16	2.000	5	No
			40	9	1.050	1.700 - 2.000	24/16	2.000	5	238240
			45	9	1.050	1.700 - 2.000	24/16	2.000	5	238241
			50	9	1.050	1.700 - 2.000	24/16	2.000	5	238242
			55	9	1.050	1.700 - 2.000	24/16	2.000	5	238243
			65	9	1.050	1.700 - 2.000	24/16	2.000	5	238244
			70	9	1.050	1.700 - 2.000	24/16	2.000	5	238245
			80	9	1.050	1.700 - 2.000	24/16	2.000	5	238246
										238247

238424



**3.2.1.19 Door lock Z-TF PT
with 2 MF + 3i.S. E94 F-24/16 K+1030**









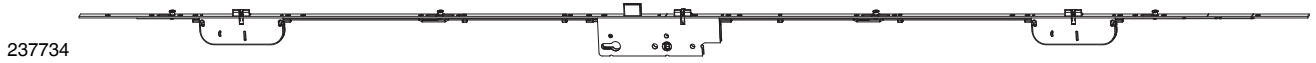



fixed handle height	silver	94	35	9	1.050	2.250 - 2.400	24/16	2.400	5	No
			40	9	1.050	2.250 - 2.400	24/16	2.400	5	238420
			45	9	1.050	2.250 - 2.400	24/16	2.400	5	238421
			50	9	1.050	2.250 - 2.400	24/16	2.400	5	238422
			55	9	1.050	2.250 - 2.400	24/16	2.400	5	238423
			65	9	1.050	2.250 - 2.400	24/16	2.400	5	238424
			70	9	1.050	2.250 - 2.400	24/16	2.400	5	238425
			80	9	1.050	2.250 - 2.400	24/16	2.400	5	238426
										238427

3.2.2 Door lock Z-TF PT with 2 MF + 4i.S.

Flat faceplate 16 mm







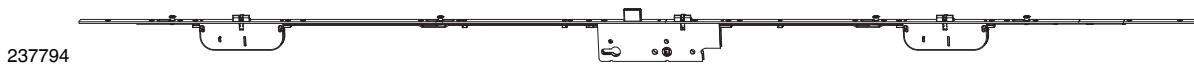





3.2.2.1 Door lock Z-TF PT with 2 MF + 4i.S. E92 F-16

											
		92	35	8	1.050	2.000 - 2.200	16	2.200	5	No	
extendable	silver	92	35	8	1.050	2.000 - 2.200	16	2.200	5	237730	
				10	1.050	2.000 - 2.200	16	2.200	5	237750	
			40	8	1.050	2.000 - 2.200	16	2.200	5	237731	
				10	1.050	2.000 - 2.200	16	2.200	5	237751	
			45	8	1.050	2.000 - 2.200	16	2.200	5	237732	
				10	1.050	2.000 - 2.200	16	2.200	5	237752	
			50	8	1.050	2.000 - 2.200	16	2.200	5	237733	
				10	1.050	2.000 - 2.200	16	2.200	5	237753	
			55	8	1.050	2.000 - 2.200	16	2.200	5	237734	
				10	1.050	2.000 - 2.200	16	2.200	5	237754	
			65	8	1.050	2.000 - 2.200	16	2.200	5	237735	
				10	1.050	2.000 - 2.200	16	2.200	5	237755	
			70	8	1.050	2.000 - 2.200	16	2.200	5	237736	
				10	1.050	2.000 - 2.200	16	2.200	5	237756	
			80	8	1.050	2.000 - 2.200	16	2.200	5	237737	
				10	1.050	2.000 - 2.200	16	2.200	5	237757	







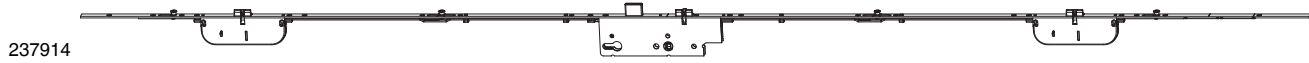

3.2.2.2 Door lock Z-TF PT with 2 MF + 4i.S. E92 F-16 K+500

											
		92	35	8	1.050	1.750 - 2.000	16	2.000	5	No	
extendable	silver	92	35	8	1.050	1.750 - 2.000	16	2.000	5	237790	
				10	1.050	1.750 - 2.000	16	2.000	5	237810	
			40	8	1.050	1.750 - 2.000	16	2.000	5	237791	
				10	1.050	1.750 - 2.000	16	2.000	5	237811	
			45	8	1.050	1.750 - 2.000	16	2.000	5	237792	
				10	1.050	1.750 - 2.000	16	2.000	5	237812	
			50	8	1.050	1.750 - 2.000	16	2.000	5	237793	
				10	1.050	1.750 - 2.000	16	2.000	5	237813	
			55	8	1.050	1.750 - 2.000	16	2.000	5	237794	
				10	1.050	1.750 - 2.000	16	2.000	5	237814	
			65	8	1.050	1.750 - 2.000	16	2.000	5	237795	
				10	1.050	1.750 - 2.000	16	2.000	5	237815	
			70	8	1.050	1.750 - 2.000	16	2.000	5	237796	
				10	1.050	1.750 - 2.000	16	2.000	5	237816	
			80	8	1.050	1.750 - 2.000	16	2.000	5	237797	
				10	1.050	1.750 - 2.000	16	2.000	5	237817	

Flat faceplate 20 mm







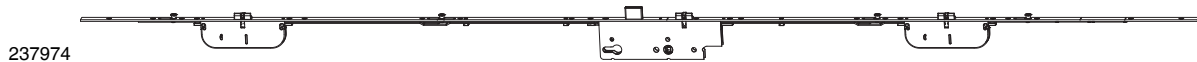

237914

3.2.2.3 Door lock Z-TF PT with 2 MF + 4i.S. E92 F-20								L		No
extendable	silver	92	35	8	1.050	2.000 - 2.200	20	2.200	5	237910
				10	1.050	2.000 - 2.200	20	2.200	5	237930
			40	8	1.050	2.000 - 2.200	20	2.200	5	237911
				10	1.050	2.000 - 2.200	20	2.200	5	237931
			45	8	1.050	2.000 - 2.200	20	2.200	5	237912
				10	1.050	2.000 - 2.200	20	2.200	5	237932
			50	8	1.050	2.000 - 2.200	20	2.200	5	237913
				10	1.050	2.000 - 2.200	20	2.200	5	237933
			55	8	1.050	2.000 - 2.200	20	2.200	5	237914
				10	1.050	2.000 - 2.200	20	2.200	5	237934
			65	8	1.050	2.000 - 2.200	20	2.200	5	237915
				10	1.050	2.000 - 2.200	20	2.200	5	237935
			70	8	1.050	2.000 - 2.200	20	2.200	5	237916
				10	1.050	2.000 - 2.200	20	2.200	5	237936
			80	8	1.050	2.000 - 2.200	20	2.200	5	237917
				10	1.050	2.000 - 2.200	20	2.200	5	237937

3







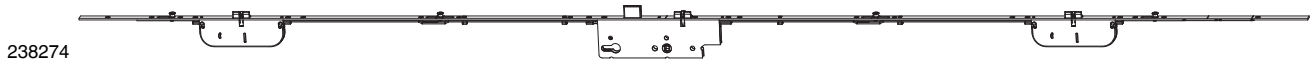

237974

3.2.2.4 Door lock Z-TF PT with 2 MF + 4i.S. E92 F-20 K+500								L		No
extendable	silver	92	35	8	1.050	1.750 - 2.000	20	2.000	5	237970
				10	1.050	1.750 - 2.000	20	2.000	5	237990
			40	8	1.050	1.750 - 2.000	20	2.000	5	237971
				10	1.050	1.750 - 2.000	20	2.000	5	237991
			45	8	1.050	1.750 - 2.000	20	2.000	5	237972
				10	1.050	1.750 - 2.000	20	2.000	5	237992
			50	8	1.050	1.750 - 2.000	20	2.000	5	237973
				10	1.050	1.750 - 2.000	20	2.000	5	237993
			55	8	1.050	1.750 - 2.000	20	2.000	5	237974
				10	1.050	1.750 - 2.000	20	2.000	5	237994
			65	8	1.050	1.750 - 2.000	20	2.000	5	237975
				10	1.050	1.750 - 2.000	20	2.000	5	237995
			70	8	1.050	1.750 - 2.000	20	2.000	5	237976
				10	1.050	1.750 - 2.000	20	2.000	5	237996
			80	8	1.050	1.750 - 2.000	20	2.000	5	237977
				10	1.050	1.750 - 2.000	20	2.000	5	237997

Flat faceplate 24 mm







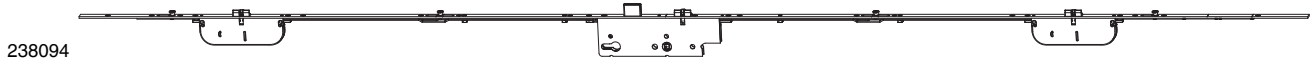

238274

3.2.2.5 Door lock Z-TF PT with 2 MF + 4i.S. E92 F-24								L		No
extendable	silver	92	35	8	1.050	2.000 - 2.200	24	2.200	5	238270
				10	1.050	2.000 - 2.200	24	2.200	5	238290
			40	8	1.050	2.000 - 2.200	24	2.200	5	238271
				10	1.050	2.000 - 2.200	24	2.200	5	238291
			45	8	1.050	2.000 - 2.200	24	2.200	5	238272
				10	1.050	2.000 - 2.200	24	2.200	5	238292
			50	8	1.050	2.000 - 2.200	24	2.200	5	238273
				10	1.050	2.000 - 2.200	24	2.200	5	238293
			55	8	1.050	2.000 - 2.200	24	2.200	5	238274
				10	1.050	2.000 - 2.200	24	2.200	5	238294
			65	8	1.050	2.000 - 2.200	24	2.200	5	238275
				10	1.050	2.000 - 2.200	24	2.200	5	238295
			70	8	1.050	2.000 - 2.200	24	2.200	5	238276
				10	1.050	2.000 - 2.200	24	2.200	5	238296
			80	8	1.050	2.000 - 2.200	24	2.200	5	238277
				10	1.050	2.000 - 2.200	24	2.200	5	238297

Top hat faceplate 24/16 mm



238094

3.2.2.6 Door lock Z-TF PT with 2 MF + 4i.S. E92 F-24/16								L		No
extendable	silver	92	35	8	1.050	2.000 - 2.200	24/16	2.200	5	238090
				10	1.050	2.000 - 2.200	24/16	2.200	5	238110
			40	8	1.050	2.000 - 2.200	24/16	2.200	5	238091
				10	1.050	2.000 - 2.200	24/16	2.200	5	238111
			45	8	1.050	2.000 - 2.200	24/16	2.200	5	238092
				10	1.050	2.000 - 2.200	24/16	2.200	5	238112
			50	8	1.050	2.000 - 2.200	24/16	2.200	5	238093
				10	1.050	2.000 - 2.200	24/16	2.200	5	238113
			55	8	1.050	2.000 - 2.200	24/16	2.200	5	238094
				10	1.050	2.000 - 2.200	24/16	2.200	5	238114
			65	8	1.050	2.000 - 2.200	24/16	2.200	5	238095
				10	1.050	2.000 - 2.200	24/16	2.200	5	238115
			70	8	1.050	2.000 - 2.200	24/16	2.200	5	238096
				10	1.050	2.000 - 2.200	24/16	2.200	5	238116
			80	8	1.050	2.000 - 2.200	24/16	2.200	5	238097
				10	1.050	2.000 - 2.200	24/16	2.200	5	238117

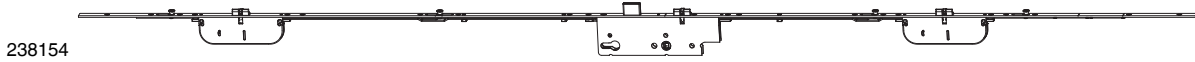

238154

3.2.2.7 Door lock Z-TF PT with 2 MF + 4i.S. E92 F-24/16 K+500								L		No
extendable	silver	92	35	8	1.050	1.750 - 2.000	24/16	2.000	5	238150
				10	1.050	1.750 - 2.000	24/16	2.000	5	238170
		40	8	1.050	1.750 - 2.000	24/16	2.000	5	238151	
			10	1.050	1.750 - 2.000	24/16	2.000	5	238171	
		45	8	1.050	1.750 - 2.000	24/16	2.000	5	238152	
			10	1.050	1.750 - 2.000	24/16	2.000	5	238172	
		50	8	1.050	1.750 - 2.000	24/16	2.000	5	238153	
			10	1.050	1.750 - 2.000	24/16	2.000	5	238173	
		55	8	1.050	1.750 - 2.000	24/16	2.000	5	238154	
			10	1.050	1.750 - 2.000	24/16	2.000	5	238174	
		65	8	1.050	1.750 - 2.000	24/16	2.000	5	238155	
			10	1.050	1.750 - 2.000	24/16	2.000	5	238175	
		70	8	1.050	1.750 - 2.000	24/16	2.000	5	238156	
			10	1.050	1.750 - 2.000	24/16	2.000	5	238176	
		80	8	1.050	1.750 - 2.000	24/16	2.000	5	238157	
			10	1.050	1.750 - 2.000	24/16	2.000	5	238177	

Flat faceplate 16 mm

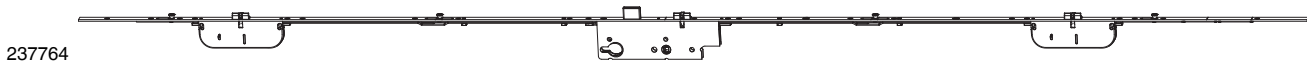

237764

3.2.2.8 Door lock Z-TF PT with 2 MF + 4i.S. E94 F-16								L		No
extendable	silver	94	35	9	1.050	2.000 - 2.200	16	2.200	5	237760
			40	9	1.050	2.000 - 2.200	16	2.200	5	237761
			45	9	1.050	2.000 - 2.200	16	2.200	5	237762
			50	9	1.050	2.000 - 2.200	16	2.200	5	237763
			55	9	1.050	2.000 - 2.200	16	2.200	5	237764
			65	9	1.050	2.000 - 2.200	16	2.200	5	237765
			70	9	1.050	2.000 - 2.200	16	2.200	5	237766
			80	9	1.050	2.000 - 2.200	16	2.200	5	237767









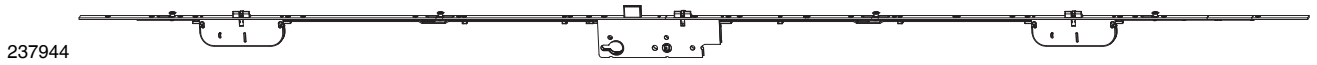





237824

3.2.2.9 Door lock Z-TF PT with 2 MF + 4i.S. E94 F-16 K+500								L		No
extendable	silver	94	35	9	1.050	1.750 - 2.000	16	2.000	5	237820
			40	9	1.050	1.750 - 2.000	16	2.000	5	237821
			45	9	1.050	1.750 - 2.000	16	2.000	5	237822
			50	9	1.050	1.750 - 2.000	16	2.000	5	237823
			55	9	1.050	1.750 - 2.000	16	2.000	5	237824
			65	9	1.050	1.750 - 2.000	16	2.000	5	237825
			70	9	1.050	1.750 - 2.000	16	2.000	5	237826
			80	9	1.050	1.750 - 2.000	16	2.000	5	237827

Flat faceplate 20 mm







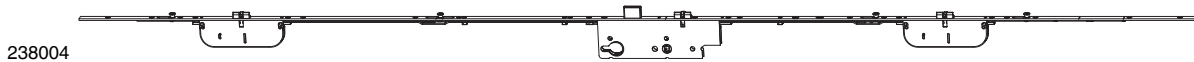







237944

3.2.2.10 Door lock Z-TF PT with 2 MF + 4i.S. E94 F-20													
extendable	silver	94	35	9	1.050	2.000 - 2.200	20	2.200	5	No			
			40	9	1.050	2.000 - 2.200	20	2.200	5	237941			
			45	9	1.050	2.000 - 2.200	20	2.200	5	237942			
			50	9	1.050	2.000 - 2.200	20	2.200	5	237943			
			55	9	1.050	2.000 - 2.200	20	2.200	5	237944			
			65	9	1.050	2.000 - 2.200	20	2.200	5	237945			
			70	9	1.050	2.000 - 2.200	20	2.200	5	237946			
			80	9	1.050	2.000 - 2.200	20	2.200	5	237947			









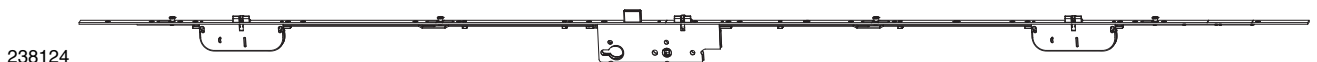





238004

3.2.2.11 Door lock Z-TF PT with 2 MF + 4i.S. E94 F-20 K+500													
extendable	silver	94	35	9	1.050	1.750 - 2.000	20	2.000	5	No			
			40	9	1.050	1.750 - 2.000	20	2.000	5	238001			
			45	9	1.050	1.750 - 2.000	20	2.000	5	238002			
			50	9	1.050	1.750 - 2.000	20	2.000	5	238003			
			55	9	1.050	1.750 - 2.000	20	2.000	5	238004			
			65	9	1.050	1.750 - 2.000	20	2.000	5	238005			
			70	9	1.050	1.750 - 2.000	20	2.000	5	238006			
			80	9	1.050	1.750 - 2.000	20	2.000	5	238007			

Top hat faceplate 24/16 mm















238124

3.2.2.12 Door lock Z-TF PT with 2 MF + 4i.S. E94 F-24/16													
extendable	silver	94	35	9	1.050	2.000 - 2.200	24/16	2.200	5	No			
			40	9	1.050	2.000 - 2.200	24/16	2.200	5	238121			
			45	9	1.050	2.000 - 2.200	24/16	2.200	5	238122			
			50	9	1.050	2.000 - 2.200	24/16	2.200	5	238123			
			55	9	1.050	2.000 - 2.200	24/16	2.200	5	238124			
			65	9	1.050	2.000 - 2.200	24/16	2.200	5	238125			
			70	9	1.050	2.000 - 2.200	24/16	2.200	5	238126			
			80	9	1.050	2.000 - 2.200	24/16	2.200	5	238127			



238184

3.2.2.13 Door lock Z-TF PT with 2 MF + 4i.S. E94 F-24/16 K+500													
extendable	silver	94	35	9	1.050	1.750 - 2.000	24/16	2.000	5	No			
			40	9	1.050	1.750 - 2.000	24/16	2.000	5	238181			
			45	9	1.050	1.750 - 2.000	24/16	2.000	5	238182			
			50	9	1.050	1.750 - 2.000	24/16	2.000	5	238183			
			55	9	1.050	1.750 - 2.000	24/16	2.000	5	238184			
			65	9	1.050	1.750 - 2.000	24/16	2.000	5	238185			
			70	9	1.050	1.750 - 2.000	24/16	2.000	5	238186			
			80	9	1.050	1.750 - 2.000	24/16	2.000	5	238187			

3.3 Door lock Z-TF PT with MF-BO

3.3.1 Door lock Z-TF PT with 2 MF-BO

Flat faceplate 16 mm

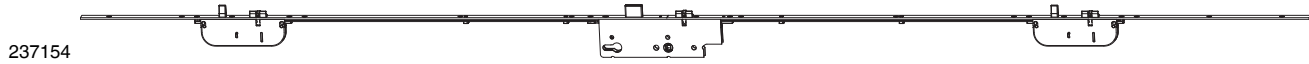

237154

3.3.1.1 Door lock Z-TF PT with 2 MF-BO E92 F-16



fixed handle height	silver	92	35	8	1.050	2.000 - 2.200	16	2.200	5	No
				10	1.050	2.000 - 2.200	16	2.200	5	237150
			40	8	1.050	2.000 - 2.200	16	2.200	5	237151
				10	1.050	2.000 - 2.200	16	2.200	5	239001
			45	8	1.050	2.000 - 2.200	16	2.200	5	237152
				10	1.050	2.000 - 2.200	16	2.200	5	239002
			50	8	1.050	2.000 - 2.200	16	2.200	5	237153
				10	1.050	2.000 - 2.200	16	2.200	5	239003
			55	8	1.050	2.000 - 2.200	16	2.200	5	237154
				10	1.050	2.000 - 2.200	16	2.200	5	239004
			65	8	1.050	2.000 - 2.200	16	2.200	5	237155
				10	1.050	2.000 - 2.200	16	2.200	5	239005
			70	8	1.050	2.000 - 2.200	16	2.200	5	237156
				10	1.050	2.000 - 2.200	16	2.200	5	239006
			80	8	1.050	2.000 - 2.200	16	2.200	5	237157
				10	1.050	2.000 - 2.200	16	2.200	5	239007

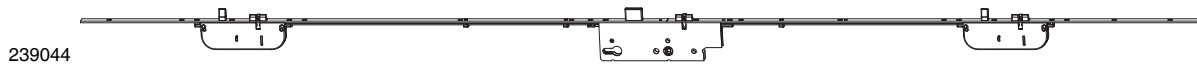

239044

3.3.1.2 Door lock Z-TF PT with 2 MF-BO E92 F-16 K+605



fixed handle height	silver	92	35	8	1.050	1.800 - 2.000	16	2.000	5	No
				10	1.050	1.800 - 2.000	16	2.000	5	239040
			40	8	1.050	1.800 - 2.000	16	2.000	5	239041
				10	1.050	1.800 - 2.000	16	2.000	5	239051
			45	8	1.050	1.800 - 2.000	16	2.000	5	239042
				10	1.050	1.800 - 2.000	16	2.000	5	239052
			50	8	1.050	1.800 - 2.000	16	2.000	5	239043
				10	1.050	1.800 - 2.000	16	2.000	5	239053
			55	8	1.050	1.800 - 2.000	16	2.000	5	239044
				10	1.050	1.800 - 2.000	16	2.000	5	239054
			65	8	1.050	1.800 - 2.000	16	2.000	5	239045
				10	1.050	1.800 - 2.000	16	2.000	5	239055
			70	8	1.050	1.800 - 2.000	16	2.000	5	239046
				10	1.050	1.800 - 2.000	16	2.000	5	239056
			80	8	1.050	1.800 - 2.000	16	2.000	5	239047
				10	1.050	1.800 - 2.000	16	2.000	5	239057

239094



**3.3.1.3 Door lock Z-TF PT
with 2 MF-BO E92 F-16 K+980**

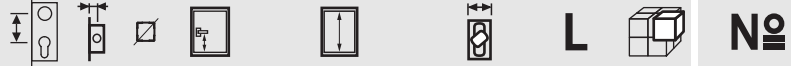

fixed handle height	silver	92	35	8	1.050	2.200 - 2.400	16	2.400	5	No
				10	1.050	2.200 - 2.400	16	2.400	5	239100
			40	8	1.050	2.200 - 2.400	16	2.400	5	239091
				10	1.050	2.200 - 2.400	16	2.400	5	239101
			45	8	1.050	2.200 - 2.400	16	2.400	5	239092
				10	1.050	2.200 - 2.400	16	2.400	5	239102
			50	8	1.050	2.200 - 2.400	16	2.400	5	239093
				10	1.050	2.200 - 2.400	16	2.400	5	239103
			55	8	1.050	2.200 - 2.400	16	2.400	5	239094
				10	1.050	2.200 - 2.400	16	2.400	5	239104
			65	8	1.050	2.200 - 2.400	16	2.400	5	239095
				10	1.050	2.200 - 2.400	16	2.400	5	239105
			70	8	1.050	2.200 - 2.400	16	2.400	5	239096
				10	1.050	2.200 - 2.400	16	2.400	5	239106
			80	8	1.050	2.200 - 2.400	16	2.400	5	239097
				10	1.050	2.200 - 2.400	16	2.400	5	239107

Flat faceplate 20 mm

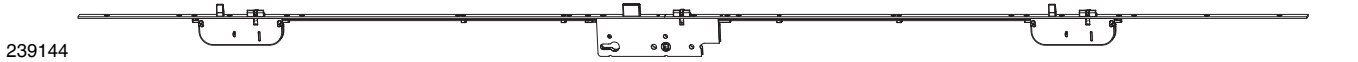

239144

**3.3.1.4 Door lock Z-TF PT
with 2 MF-BO E92 F-20**

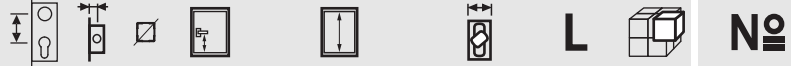

fixed handle height	silver	92	35	8	1.050	1.800 - 2.000	20	2.200	5	No
				10	1.050	1.800 - 2.000	20	2.200	5	239150
			40	8	1.050	1.800 - 2.000	20	2.200	5	239141
				10	1.050	1.800 - 2.000	20	2.200	5	239151
			45	8	1.050	1.800 - 2.000	20	2.200	5	239142
				10	1.050	1.800 - 2.000	20	2.200	5	239152
			50	8	1.050	1.800 - 2.000	20	2.200	5	239143
				10	1.050	1.800 - 2.000	20	2.200	5	239153
			55	8	1.050	1.800 - 2.000	20	2.200	5	239144
				10	1.050	1.800 - 2.000	20	2.200	5	239154
			65	8	1.050	1.800 - 2.000	20	2.200	5	239145
				10	1.050	1.800 - 2.000	20	2.200	5	239155
			70	8	1.050	1.800 - 2.000	20	2.200	5	239146
				10	1.050	1.800 - 2.000	20	2.200	5	239156
			80	8	1.050	1.800 - 2.000	20	2.200	5	239147
				10	1.050	1.800 - 2.000	20	2.200	5	239157



239194

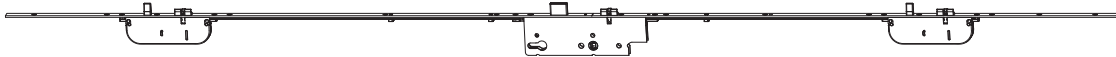

**3.3.1.5 Door lock Z-TF PT
with 2 MF-BO E92 F-20 K+605**



fixed handle height	silver	92	35	8	1.050	1.800 - 2.000	20	2.000	5	No
				10	1.050	1.800 - 2.000	20	2.000	5	239190
			40	8	1.050	1.800 - 2.000	20	2.000	5	239191
				10	1.050	1.800 - 2.000	20	2.000	5	239201
			45	8	1.050	1.800 - 2.000	20	2.000	5	239192
				10	1.050	1.800 - 2.000	20	2.000	5	239202
			50	8	1.050	1.800 - 2.000	20	2.000	5	239193
				10	1.050	1.800 - 2.000	20	2.000	5	239203
			55	8	1.050	1.800 - 2.000	20	2.000	5	239194
				10	1.050	1.800 - 2.000	20	2.000	5	239204
			65	8	1.050	1.800 - 2.000	20	2.000	5	239195
				10	1.050	1.800 - 2.000	20	2.000	5	239205
			70	8	1.050	1.800 - 2.000	20	2.000	5	239196
				10	1.050	1.800 - 2.000	20	2.000	5	239206
			80	8	1.050	1.800 - 2.000	20	2.000	5	239197
				10	1.050	1.800 - 2.000	20	2.000	5	239207

239244



**3.3.1.6 Door lock Z-TF PT
with 2 MF-BO E92 F-20 K+980**







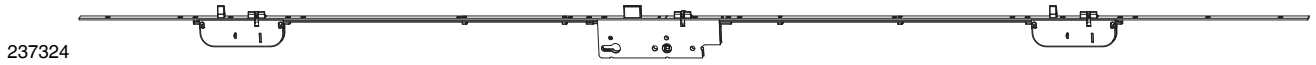

fixed handle height	silver	92	35	8	1.050	2.200 - 2.400	20	2.400	5	No
				10	1.050	2.200 - 2.400	20	2.400	5	239240
			40	8	1.050	2.200 - 2.400	20	2.400	5	239241
				10	1.050	2.200 - 2.400	20	2.400	5	239251
			45	8	1.050	2.200 - 2.400	20	2.400	5	239242
				10	1.050	2.200 - 2.400	20	2.400	5	239252
			50	8	1.050	2.200 - 2.400	20	2.400	5	239243
				10	1.050	2.200 - 2.400	20	2.400	5	239253
			55	8	1.050	2.200 - 2.400	20	2.400	5	239244
				10	1.050	2.200 - 2.400	20	2.400	5	239254
			65	8	1.050	2.200 - 2.400	20	2.400	5	239245
				10	1.050	2.200 - 2.400	20	2.400	5	239255
			70	8	1.050	2.200 - 2.400	20	2.400	5	239246
				10	1.050	2.200 - 2.400	20	2.400	5	239256
			80	8	1.050	2.200 - 2.400	20	2.400	5	239247
				10	1.050	2.200 - 2.400	20	2.400	5	239257

Flat faceplate 24 mm







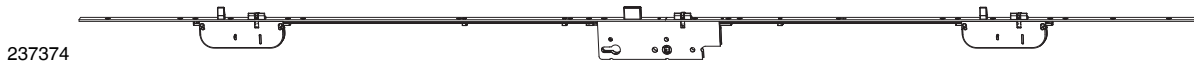

237324

3.3.1.7 Door lock Z-TF PT with 2 MF-BO E92 F-24								L		No
fixed handle height	silver	92	35	8	1.050	2.000 - 2.200	24	2.200	5	237320
				10	1.050	2.000 - 2.200	24	2.200	5	237330
			40	8	1.050	2.000 - 2.200	24	2.200	5	237321
				10	1.050	2.000 - 2.200	24	2.200	5	237331
			45	8	1.050	2.000 - 2.200	24	2.200	5	237322
				10	1.050	2.000 - 2.200	24	2.200	5	237332
			50	8	1.050	2.000 - 2.200	24	2.200	5	237323
				10	1.050	2.000 - 2.200	24	2.200	5	237333
			55	8	1.050	2.000 - 2.200	24	2.200	5	237324
				10	1.050	2.000 - 2.200	24	2.200	5	237334
			65	8	1.050	2.000 - 2.200	24	2.200	5	237325
				10	1.050	2.000 - 2.200	24	2.200	5	237335
			70	8	1.050	2.000 - 2.200	24	2.200	5	237326
				10	1.050	2.000 - 2.200	24	2.200	5	237336
			80	8	1.050	2.000 - 2.200	24	2.200	5	237327
				10	1.050	2.000 - 2.200	24	2.200	5	237337



237374

3.3.1.8 Door lock Z-TF PT with 2 MF-BO E92 F-24 K+605								L		No
fixed handle height	silver	92	35	8	1.050	1.800 - 2.000	24	2.000	5	237370
				10	1.050	1.800 - 2.000	24	2.000	5	237380
			40	8	1.050	1.800 - 2.000	24	2.000	5	237371
				10	1.050	1.800 - 2.000	24	2.000	5	237381
			45	8	1.050	1.800 - 2.000	24	2.000	5	237372
				10	1.050	1.800 - 2.000	24	2.000	5	237382
			50	8	1.050	1.800 - 2.000	24	2.000	5	237373
				10	1.050	1.800 - 2.000	24	2.000	5	237383
			55	8	1.050	1.800 - 2.000	24	2.000	5	237374
				10	1.050	1.800 - 2.000	24	2.000	5	237384
			65	8	1.050	1.800 - 2.000	24	2.000	5	237375
				10	1.050	1.800 - 2.000	24	2.000	5	237385
			70	8	1.050	1.800 - 2.000	24	2.000	5	237376
				10	1.050	1.800 - 2.000	24	2.000	5	237386
			80	8	1.050	1.800 - 2.000	24	2.000	5	237377
				10	1.050	1.800 - 2.000	24	2.000	5	237387

237394



**3.3.1.9 Door lock Z-TF PT
with 2 MF-BO E92 F-24 K+980**

								L		No
fixed handle height	silver	92	35	8	1.050	2.200 - 2.400	24	2.400	5	237390
				10	1.050	2.200 - 2.400	24	2.400	5	237400
			40	8	1.050	2.200 - 2.400	24	2.400	5	237391
				10	1.050	2.200 - 2.400	24	2.400	5	237401
			45	8	1.050	2.200 - 2.400	24	2.400	5	237392
				10	1.050	2.200 - 2.400	24	2.400	5	237402
			50	8	1.050	2.200 - 2.400	24	2.400	5	237393
				10	1.050	2.200 - 2.400	24	2.400	5	237403
			55	8	1.050	2.200 - 2.400	24	2.400	5	237394
				10	1.050	2.200 - 2.400	24	2.400	5	237404
			65	8	1.050	2.200 - 2.400	24	2.400	5	237395
				10	1.050	2.200 - 2.400	24	2.400	5	237405
			70	8	1.050	2.200 - 2.400	24	2.400	5	237396
				10	1.050	2.200 - 2.400	24	2.400	5	237406
			80	8	1.050	2.200 - 2.400	24	2.400	5	237397
				10	1.050	2.200 - 2.400	24	2.400	5	237407

3

Top hat faceplate 24/16 mm

239324

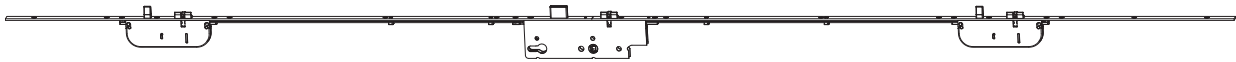

**3.3.1.10 Door lock Z-TF PT
with 2 MF-BO E92 F-24/16**

								L		No
fixed handle height	silver	92	35	8	1.050	2.000 - 2.200	24/16	2.200	5	239320
				10	1.050	2.000 - 2.200	24/16	2.200	5	239330
			40	8	1.050	2.000 - 2.200	24/16	2.200	5	239321
				10	1.050	2.000 - 2.200	24/16	2.200	5	239331
			45	8	1.050	2.000 - 2.200	24/16	2.200	5	239322
				10	1.050	2.000 - 2.200	24/16	2.200	5	239332
			50	8	1.050	2.000 - 2.200	24/16	2.200	5	239323
				10	1.050	2.000 - 2.200	24/16	2.200	5	239333
			55	8	1.050	2.000 - 2.200	24/16	2.200	5	239324
				10	1.050	2.000 - 2.200	24/16	2.200	5	239334
			65	8	1.050	2.000 - 2.200	24/16	2.200	5	239325
				10	1.050	2.000 - 2.200	24/16	2.200	5	239335
			70	8	1.050	2.000 - 2.200	24/16	2.200	5	239326
				10	1.050	2.000 - 2.200	24/16	2.200	5	239336
			80	8	1.050	2.000 - 2.200	24/16	2.200	5	239327
				10	1.050	2.000 - 2.200	24/16	2.200	5	239337

239374

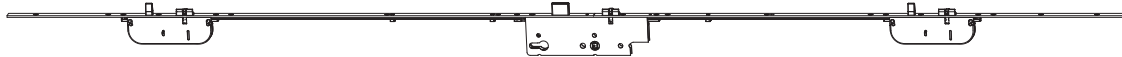

**3.3.1.11 Door lock Z-TF PT
with 2 MF-BO E92 F-24/16 K+605**



fixed handle height	silver	92	35	8	1.050	1.800 - 2.000	24/16	2.000	5	No
				10	1.050	1.800 - 2.000	24/16	2.000	5	239370
			40	8	1.050	1.800 - 2.000	24/16	2.000	5	239380
				10	1.050	1.800 - 2.000	24/16	2.000	5	239371
			45	8	1.050	1.800 - 2.000	24/16	2.000	5	239381
				10	1.050	1.800 - 2.000	24/16	2.000	5	239372
			50	8	1.050	1.800 - 2.000	24/16	2.000	5	239382
				10	1.050	1.800 - 2.000	24/16	2.000	5	239373
			55	8	1.050	1.800 - 2.000	24/16	2.000	5	239383
				10	1.050	1.800 - 2.000	24/16	2.000	5	239374
			65	8	1.050	1.800 - 2.000	24/16	2.000	5	239384
				10	1.050	1.800 - 2.000	24/16	2.000	5	239375
			70	8	1.050	1.800 - 2.000	24/16	2.000	5	239385
				10	1.050	1.800 - 2.000	24/16	2.000	5	239376
			80	8	1.050	1.800 - 2.000	24/16	2.000	5	239386
				10	1.050	1.800 - 2.000	24/16	2.000	5	239377
				10	1.050	1.800 - 2.000	24/16	2.000	5	239387

239424



**3.3.1.12 Door lock Z-TF PT
with 2 MF-BO E92 F-24/16 K+980**



fixed handle height	silver	92	35	8	1.050	2.200 - 2.400	24/16	2.400	5	No
				10	1.050	2.200 - 2.400	24/16	2.400	5	239420
			40	8	1.050	2.200 - 2.400	24/16	2.400	5	239430
				10	1.050	2.200 - 2.400	24/16	2.400	5	239421
			45	8	1.050	2.200 - 2.400	24/16	2.400	5	239431
				10	1.050	2.200 - 2.400	24/16	2.400	5	239422
			50	8	1.050	2.200 - 2.400	24/16	2.400	5	239432
				10	1.050	2.200 - 2.400	24/16	2.400	5	239423
			55	8	1.050	2.200 - 2.400	24/16	2.400	5	239433
				10	1.050	2.200 - 2.400	24/16	2.400	5	239424
			65	8	1.050	2.200 - 2.400	24/16	2.400	5	239434
				10	1.050	2.200 - 2.400	24/16	2.400	5	239425
			70	8	1.050	2.200 - 2.400	24/16	2.400	5	239435
				10	1.050	2.200 - 2.400	24/16	2.400	5	239426
			80	8	1.050	2.200 - 2.400	24/16	2.400	5	239436
				10	1.050	2.200 - 2.400	24/16	2.400	5	239427
				10	1.050	2.200 - 2.400	24/16	2.400	5	239437

U-faceplate 6x24x6 mm

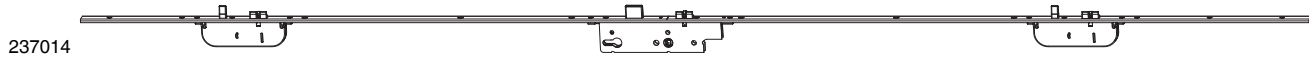

237014

3.3.1.13 Door lock Z-TF PT with 2 MF-BO E92 U-6x24x6								L		No
fixed handle height	silver	92	35	8	1.050	1.950 - 2.200	24	2.200	5	237010
				10	1.050	1.950 - 2.200	24	2.200	5	237180
			40	8	1.050	1.950 - 2.200	24	2.200	5	237011
				10	1.050	1.950 - 2.200	24	2.200	5	237181
			45	8	1.050	1.950 - 2.200	24	2.200	5	237012
				10	1.050	1.950 - 2.200	24	2.200	5	237182
			50	8	1.050	1.950 - 2.200	24	2.200	5	237013
				10	1.050	1.950 - 2.200	24	2.200	5	237183
			55	8	1.050	1.950 - 2.200	24	2.200	5	237014
				10	1.050	1.950 - 2.200	24	2.200	5	237184
			65	8	1.050	1.950 - 2.200	24	2.200	5	237015
				10	1.050	1.950 - 2.200	24	2.200	5	237185
			70	8	1.050	1.950 - 2.200	24	2.200	5	237016
				10	1.050	1.950 - 2.200	24	2.200	5	237186
			80	8	1.050	1.950 - 2.200	24	2.200	5	237017
				10	1.050	1.950 - 2.200	24	2.200	5	237187

3

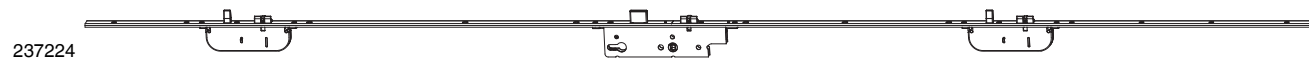

237224

3.3.1.14 Door lock Z-TF PT with 2 MF-BO E92 U-6x24x6 K+605								L		No
fixed handle height	silver	92	35	8	1.050	1.800 - 2.000	24	2.200	5	237220
				10	1.050	1.800 - 2.000	24	2.200	5	237230
			40	8	1.050	1.800 - 2.000	24	2.200	5	237221
				10	1.050	1.800 - 2.000	24	2.200	5	237231
			45	8	1.050	1.800 - 2.000	24	2.200	5	237222
				10	1.050	1.800 - 2.000	24	2.200	5	237232
			50	8	1.050	1.800 - 2.000	24	2.200	5	237223
				10	1.050	1.800 - 2.000	24	2.200	5	237233
			55	8	1.050	1.800 - 2.000	24	2.200	5	237224
				10	1.050	1.800 - 2.000	24	2.200	5	237234
			65	8	1.050	1.800 - 2.000	24	2.200	5	237225
				10	1.050	1.800 - 2.000	24	2.200	5	237235
			70	8	1.050	1.800 - 2.000	24	2.200	5	237226
				10	1.050	1.800 - 2.000	24	2.200	5	237236
			80	8	1.050	1.800 - 2.000	24	2.200	5	237227
				10	1.050	1.800 - 2.000	24	2.200	5	237237

237274

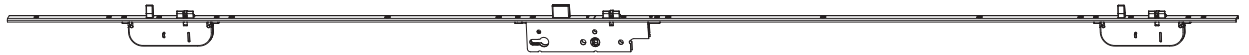

**3.3.1.15 Door lock Z-TF PT
with 2 MF-BO E92 U-6x24x6 K+980**



fixed handle height	silver	92	35	8	1.050	2.200 - 2.400	24	2.200	5	No
				10	1.050	2.200 - 2.400	24	2.200	5	237280
			40	8	1.050	2.200 - 2.400	24	2.200	5	237271
				10	1.050	2.200 - 2.400	24	2.200	5	237281
			45	8	1.050	2.200 - 2.400	24	2.200	5	237272
				10	1.050	2.200 - 2.400	24	2.200	5	237282
			50	8	1.050	2.200 - 2.400	24	2.200	5	237273
				10	1.050	2.200 - 2.400	24	2.200	5	237283
			55	8	1.050	2.200 - 2.400	24	2.200	5	237274
				10	1.050	2.200 - 2.400	24	2.200	5	237284
			65	8	1.050	2.200 - 2.400	24	2.200	5	237275
				10	1.050	2.200 - 2.400	24	2.200	5	237285
			70	8	1.050	2.200 - 2.400	24	2.200	5	237276
				10	1.050	2.200 - 2.400	24	2.200	5	237286
			80	8	1.050	2.200 - 2.400	24	2.200	5	237277
				10	1.050	2.200 - 2.400	24	2.200	5	237287

Flat faceplate 16 mm

239024

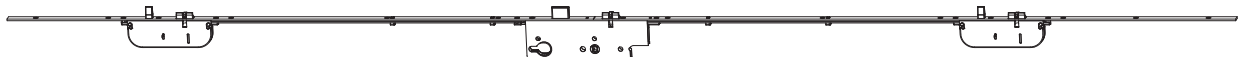

**3.3.1.16 Door lock Z-TF PT
with 2 MF-BO E94 F-16**



fixed handle height	silver	94	35	9	1.050	2.000 - 2.200	16	2.200	5	No
			40	9	1.050	2.000 - 2.200	16	2.200	5	239021
			45	9	1.050	2.000 - 2.200	16	2.200	5	239022
			50	9	1.050	2.000 - 2.200	16	2.200	5	239023
			55	9	1.050	2.000 - 2.200	16	2.200	5	239024
			65	9	1.050	2.000 - 2.200	16	2.200	5	239025
			70	9	1.050	2.000 - 2.200	16	2.200	5	239026
			80	9	1.050	2.000 - 2.200	16	2.200	5	239027

239074



**3.3.1.17 Door lock Z-TF PT
with 2 MF-BO E94 F-16 K+605**



fixed handle height	silver	94	35	9	1.050	2.000 - 2.200	16	2.000	5	No
			40	9	1.050	2.000 - 2.200	16	2.000	5	239071
			45	9	1.050	2.000 - 2.200	16	2.000	5	239072
			50	9	1.050	2.000 - 2.200	16	2.000	5	239073
			55	9	1.050	2.000 - 2.200	16	2.000	5	239074
			65	9	1.050	2.000 - 2.200	16	2.000	5	239075
			70	9	1.050	2.000 - 2.200	16	2.000	5	239076
			80	9	1.050	2.000 - 2.200	16	2.000	5	239077

239124



**3.3.1.18 Door lock Z-TF PT
with 2 MF-BO E94 F-16 K+980**



fixed handle height	silver	94	35	9	1.050	2.000 - 2.200	16	2.400	5	№
			40	9	1.050	2.000 - 2.200	16	2.400	5	239120
			45	9	1.050	2.000 - 2.200	16	2.400	5	239121
			50	9	1.050	2.000 - 2.200	16	2.400	5	239122
			55	9	1.050	2.000 - 2.200	16	2.400	5	239123
			65	9	1.050	2.000 - 2.200	16	2.400	5	239124
			70	9	1.050	2.000 - 2.200	16	2.400	5	239125
			80	9	1.050	2.000 - 2.200	16	2.400	5	239126
										239127

Flat faceplate 20 mm

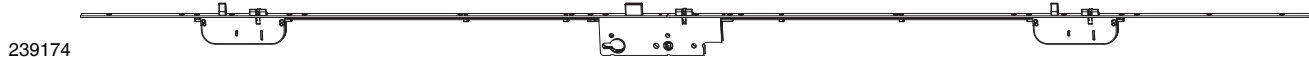

239174

**3.3.1.19 Door lock Z-TF PT
with 2 MF-BO E94 F-20**



fixed handle height	silver	94	35	9	1.050	1.800 - 2.000	20	2.200	5	№
			40	9	1.050	1.800 - 2.000	20	2.200	5	239170
			45	9	1.050	1.800 - 2.000	20	2.200	5	239171
			50	9	1.050	1.800 - 2.000	20	2.200	5	239172
			55	9	1.050	1.800 - 2.000	20	2.200	5	239173
			65	9	1.050	1.800 - 2.000	20	2.200	5	239174
			70	9	1.050	1.800 - 2.000	20	2.200	5	239175
			80	9	1.050	1.800 - 2.000	20	2.200	5	239176
										239177



239224

**3.3.1.20 Door lock Z-TF PT
with 2 MF-BO E94 F-20 K+605**



fixed handle height	silver	94	35	9	1.050	2.000 - 2.200	20	2.000	5	№
			40	9	1.050	2.000 - 2.200	20	2.000	5	239220
			45	9	1.050	2.000 - 2.200	20	2.000	5	239221
			50	9	1.050	2.000 - 2.200	20	2.000	5	239222
			55	9	1.050	2.000 - 2.200	20	2.000	5	239223
			65	9	1.050	2.000 - 2.200	20	2.000	5	239224
			70	9	1.050	2.000 - 2.200	20	2.000	5	239225
			80	9	1.050	2.000 - 2.200	20	2.000	5	239226
										239227

239274



**3.3.1.21 Door lock Z-TF PT
with 2 MF-BO E94 F-20 K+980**



fixed handle height	silver	94	35	9	1.050	2.200 - 2.400	20	2.400	5	No
			40	9	1.050	2.200 - 2.400	20	2.400	5	239270
			45	9	1.050	2.200 - 2.400	20	2.400	5	239271
			50	9	1.050	2.200 - 2.400	20	2.400	5	239272
			55	9	1.050	2.200 - 2.400	20	2.400	5	239273
			55	9	1.050	2.200 - 2.400	20	2.400	5	239274
			65	9	1.050	2.200 - 2.400	20	2.400	5	239275
			70	9	1.050	2.200 - 2.400	20	2.400	5	239276
			80	9	1.050	2.200 - 2.400	20	2.400	5	239277

Flat faceplate 24 mm

237354

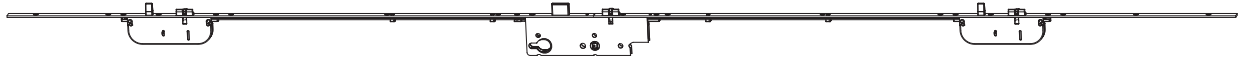

**3.3.1.22 Door lock Z-TF PT
with 2 MF-BO E94 F-24**



fixed handle height	silver	94	35	9	1.050	2.000 - 2.200	24	2.200	5	No
			40	9	1.050	2.000 - 2.200	24	2.200	5	237350
			45	9	1.050	2.000 - 2.200	24	2.200	5	237351
			50	9	1.050	2.000 - 2.200	24	2.200	5	237352
			50	9	1.050	2.000 - 2.200	24	2.200	5	237353
			55	9	1.050	2.000 - 2.200	24	2.200	5	237354
			65	9	1.050	2.000 - 2.200	24	2.200	5	237355
			70	9	1.050	2.000 - 2.200	24	2.200	5	237356
			80	9	1.050	2.000 - 2.200	24	2.200	5	237357

237484

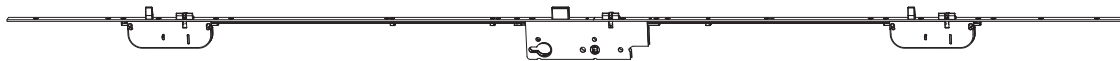

**3.3.1.23 Door lock Z-TF PT
with 2 MF-BO E94 F-24 K+605**



fixed handle height	silver	94	35	9	1.050	1.800 - 2.000	24	2.000	5	No
			40	9	1.050	1.800 - 2.000	24	2.000	5	237480
			45	9	1.050	1.800 - 2.000	24	2.000	5	237481
			50	9	1.050	1.800 - 2.000	24	2.000	5	237482
			50	9	1.050	1.800 - 2.000	24	2.000	5	237483
			55	9	1.050	1.800 - 2.000	24	2.000	5	237484
			65	9	1.050	1.800 - 2.000	24	2.000	5	237485
			70	9	1.050	1.800 - 2.000	24	2.000	5	237486
			80	9	1.050	1.800 - 2.000	24	2.000	5	237487

239304



**3.3.1.24 Door lock Z-TF PT
with 2 MF-BO E94 F-24 K+980**



fixed handle height	silver	94	35	9	1.050	2.200 - 2.400	24	2.400	5	239300
			40	9	1.050	2.200 - 2.400	24	2.400	5	239301
			45	9	1.050	2.200 - 2.400	24	2.400	5	239302
			50	9	1.050	2.200 - 2.400	24	2.400	5	239303
			55	9	1.050	2.200 - 2.400	24	2.400	5	239304
			65	9	1.050	2.200 - 2.400	24	2.400	5	239305
			70	9	1.050	2.200 - 2.400	24	2.400	5	239306
			80	9	1.050	2.200 - 2.400	24	2.400	5	239307

Top hat faceplate 24/16 mm

239354

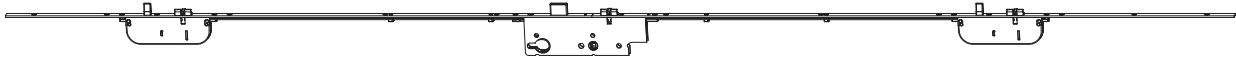

**3.3.1.25 Door lock Z-TF PT
with 2 MF-BO E94 F-24/16**



fixed handle height	silver	94	35	9	1.050	2.000 - 2.200	24/16	2.200	5	239350
			40	9	1.050	2.000 - 2.200	24/16	2.200	5	239351
			45	9	1.050	2.000 - 2.200	24/16	2.200	5	239352
			50	9	1.050	2.000 - 2.200	24/16	2.200	5	239353
			55	9	1.050	2.000 - 2.200	24/16	2.200	5	239354
			65	9	1.050	2.000 - 2.200	24/16	2.200	5	239355
			70	9	1.050	2.000 - 2.200	24/16	2.200	5	239356
			80	9	1.050	2.000 - 2.200	24/16	2.200	5	239357

239404

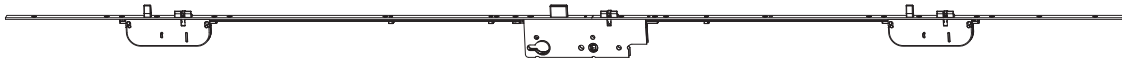

**3.3.1.26 Door lock Z-TF PT
with 2 MF-BO E94 F-24/16 K+605**



fixed handle height	silver	94	35	9	1.050	1.800 - 2.000	24/16	2.000	5	239400
			40	9	1.050	1.800 - 2.000	24/16	2.000	5	239401
			45	9	1.050	1.800 - 2.000	24/16	2.000	5	239402
			50	9	1.050	1.800 - 2.000	24/16	2.000	5	239403
			55	9	1.050	1.800 - 2.000	24/16	2.000	5	239404
			65	9	1.050	1.800 - 2.000	24/16	2.000	5	239405
			70	9	1.050	1.800 - 2.000	24/16	2.000	5	239406
			80	9	1.050	1.800 - 2.000	24/16	2.000	5	239407

239454



3.3.1.27 Door lock Z-TF PT with 2 MF-BO E94 F-24/16 K+980								L		No
fixed handle height	silver	94	35	9	1.050	2.200 - 2.400	24/16	2.400	5	239450
			40	9	1.050	2.200 - 2.400	24/16	2.400	5	239451
			45	9	1.050	2.200 - 2.400	24/16	2.400	5	239452
			50	9	1.050	2.200 - 2.400	24/16	2.400	5	239453
			55	9	1.050	2.200 - 2.400	24/16	2.400	5	239454
			65	9	1.050	2.200 - 2.400	24/16	2.400	5	239455
			70	9	1.050	2.200 - 2.400	24/16	2.400	5	239456
			80	9	1.050	2.200 - 2.400	24/16	2.400	5	239457

U-faceplate 6x24x6 mm

237204

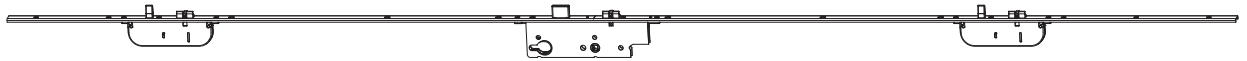

3.3.1.28 Door lock Z-TF PT with 2 MF-BO E94 U-6x24x6								L		No
fixed handle height	silver	94	35	9	1.050	1.950 - 2.200	24	2.200	5	237200
			40	9	1.050	1.950 - 2.200	24	2.200	5	237201
			45	9	1.050	1.950 - 2.200	24	2.200	5	237202
			50	9	1.050	1.950 - 2.200	24	2.200	5	237203
			55	9	1.050	1.950 - 2.200	24	2.200	5	237204
			65	9	1.050	1.950 - 2.200	24	2.200	5	237205
			70	9	1.050	1.950 - 2.200	24	2.200	5	237206
			80	9	1.050	1.950 - 2.200	24	2.200	5	237207

237254

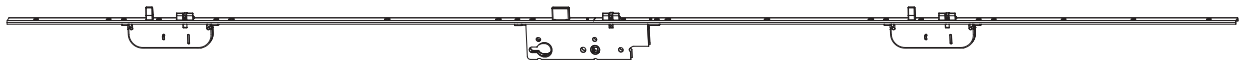

3.3.1.29 Door lock Z-TF PT with 2 MF-BO E94 U-6x24x6 K+605								L		No
fixed handle height	silver	94	35	9	1.050	1.950 - 2.200	24	2.200	5	237250
			40	9	1.050	1.950 - 2.200	24	2.200	5	237251
			45	9	1.050	1.950 - 2.200	24	2.200	5	237252
			50	9	1.050	1.950 - 2.200	24	2.200	5	237253
			55	9	1.050	1.950 - 2.200	24	2.200	5	237254
			65	9	1.050	1.950 - 2.200	24	2.200	5	237255
			70	9	1.050	1.950 - 2.200	24	2.200	5	237256
			80	9	1.050	1.950 - 2.200	24	2.200	5	237257



237304

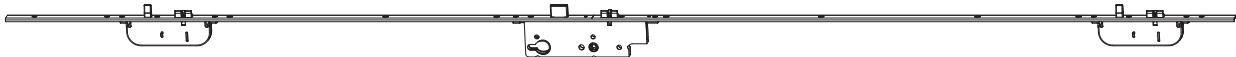

3.3.1.30 Door lock Z-TF PT with 2 MF-BO E94 U-6x24x6 K+980								L		No
fixed handle height	silver	94	35	9	1.050	1.950 - 2.200	24	2.200	5	237300
			40	9	1.050	1.950 - 2.200	24	2.200	5	237301
			45	9	1.050	1.950 - 2.200	24	2.200	5	237302
			50	9	1.050	1.950 - 2.200	24	2.200	5	237303
			55	9	1.050	1.950 - 2.200	24	2.200	5	237304
			65	9	1.050	1.950 - 2.200	24	2.200	5	237305
			70	9	1.050	1.950 - 2.200	24	2.200	5	237306
			80	9	1.050	1.950 - 2.200	24	2.200	5	237307

**MACO
PROTECT**



Z-TF Triple Latch Door Lock



4 Z-TS Cylinder Operated Door Lock

4.1	Hardware overview Z-TS _____	72
4.2	Door lock Z-TS Module with i.S. _____	78
4.3	Door lock Z-TS Module with i.S. + ZS _____	82
4.4	Door lock Z-TS Module PT-M with 2 HO-BO + i.S. _____	83
4.5	Door lock Z-TS Module PT-M with HO-BO _____	84
4.6	Door lock Z-TS Module with hook-bolt + ZS _____	94
4.7	Door lock Z-TS Module with HO + i.S. _____	95
4.8	Door lock Z-TS Module with HO _____	96
4.9	Door lock Z-TS Module with HO + ZS _____	101
4.10	Door lock Z-TS Module with BO + i.S. _____	102
4.11	Door lock Z-TS Module with BO _____	103
4.12	Door lock Z-TS Module with bolts + ZS _____	109

4 Z-TS Cylinder Operated Door Lock

4.1 Hardware overview Z-TS

3.1m

MACO PROTECT MODULE

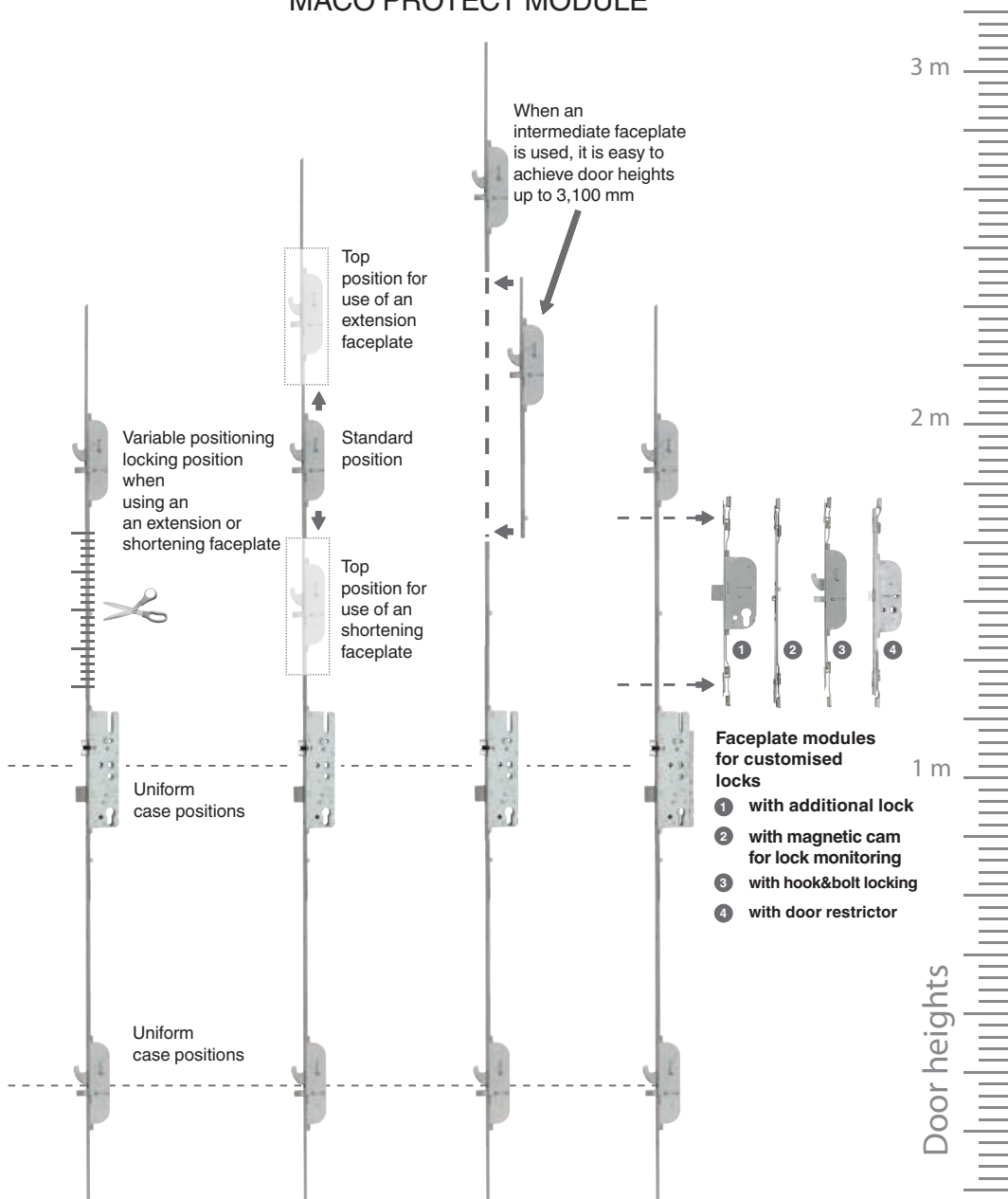

- ① 2 x hook&bolt
- ② 4 x hook&bolt
- ③ 2x hook&bolt + additional lock

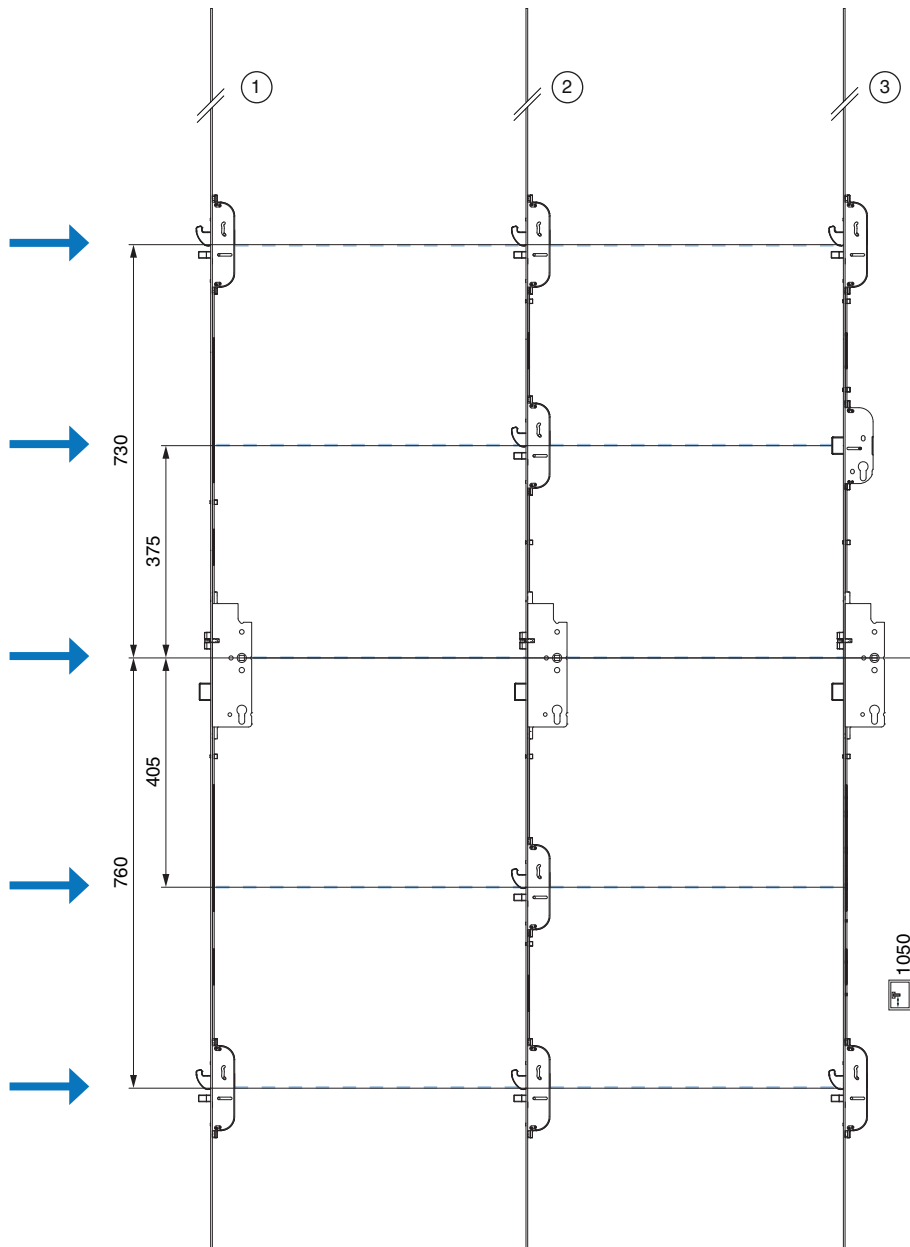

- ① standard lock
- ② shortening faceplate
- ③ extension faceplate

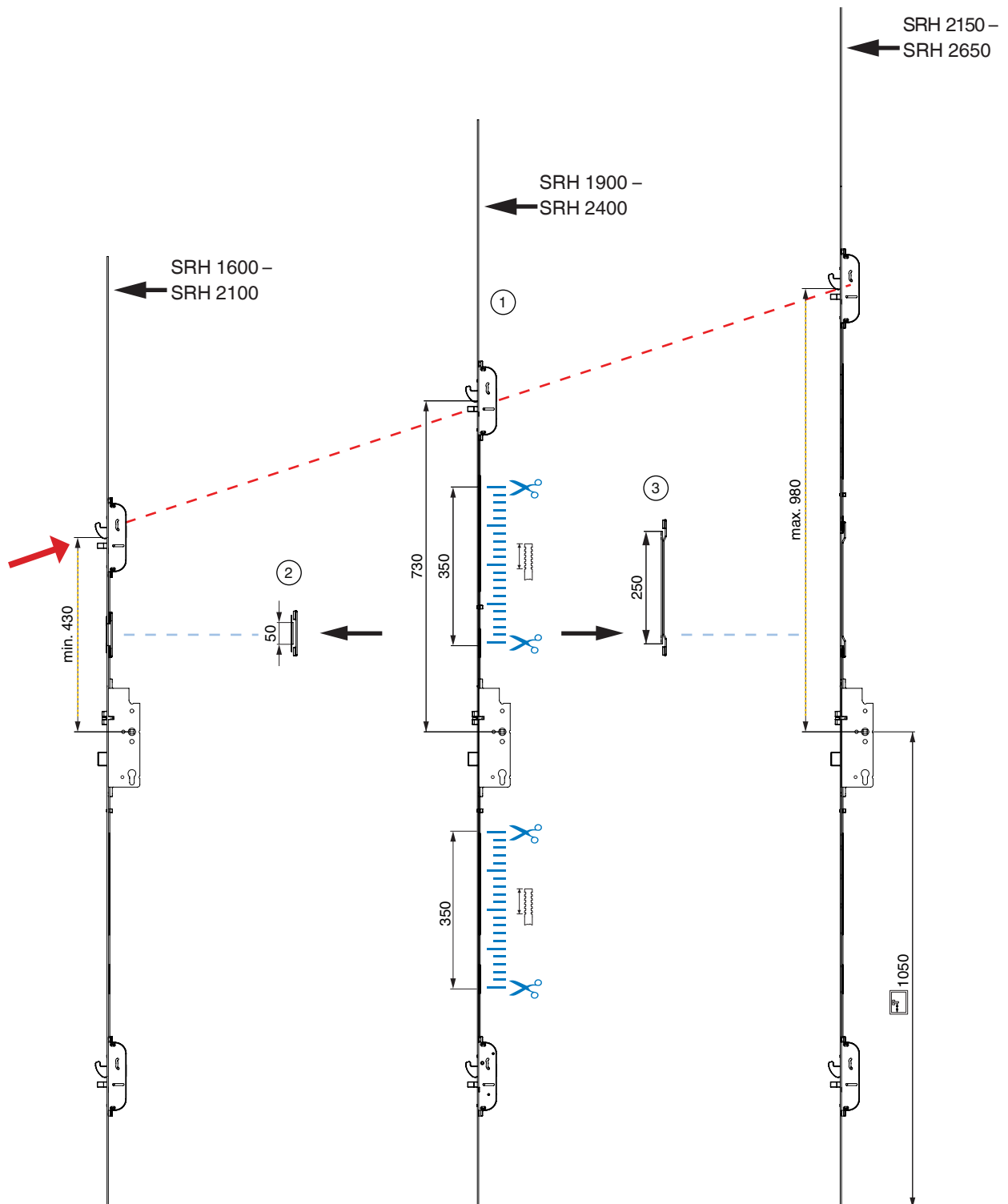

- ① standard lock
- ② faceplate module ZS
- ③ faceplate module hook&bolt
- ④ faceplate module magnetic cam
- ⑤ faceplate module door restrictor

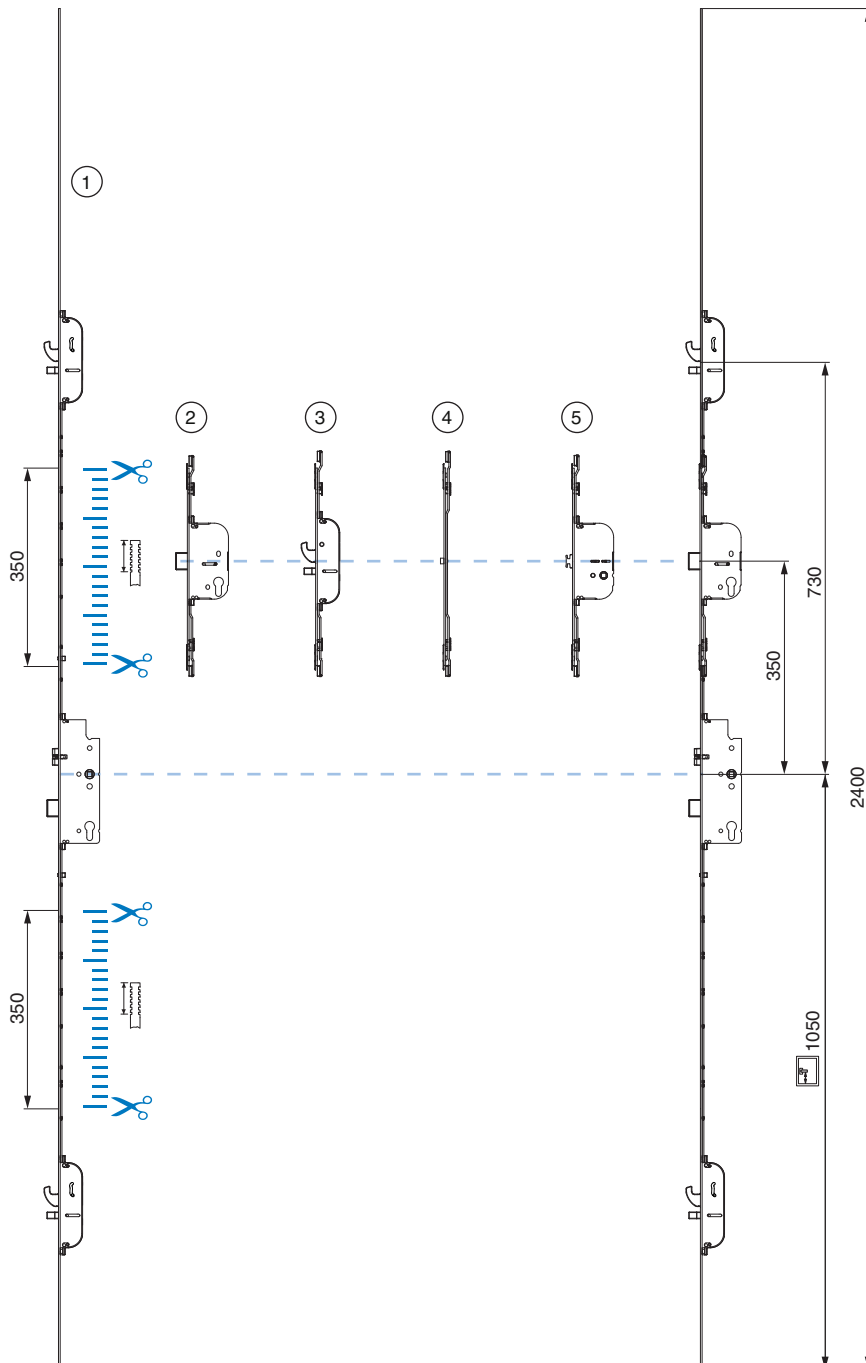



2 hook&bolt

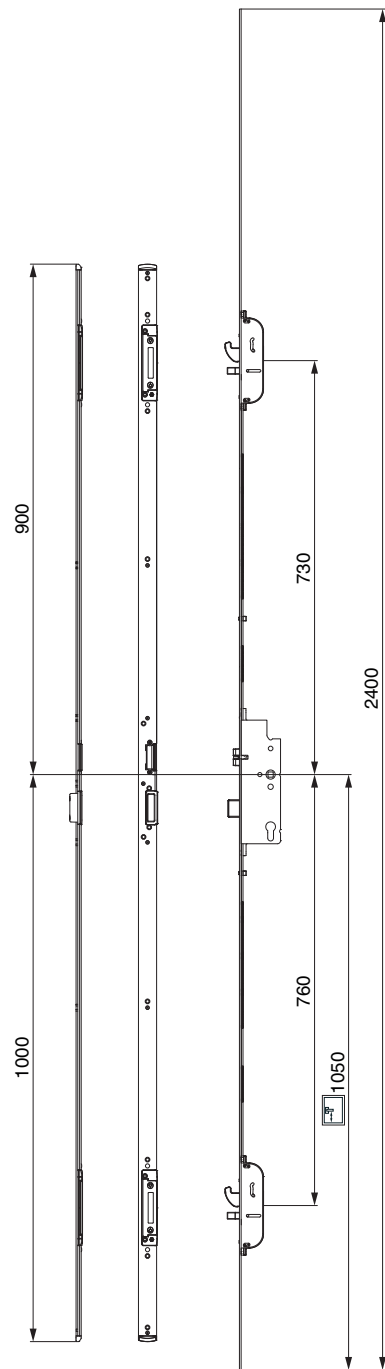
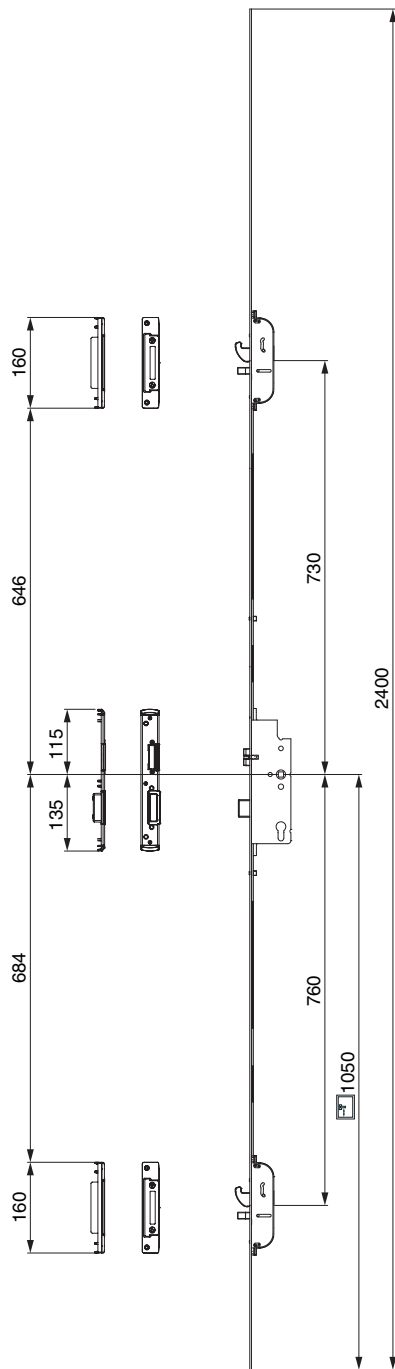



4 i.S.

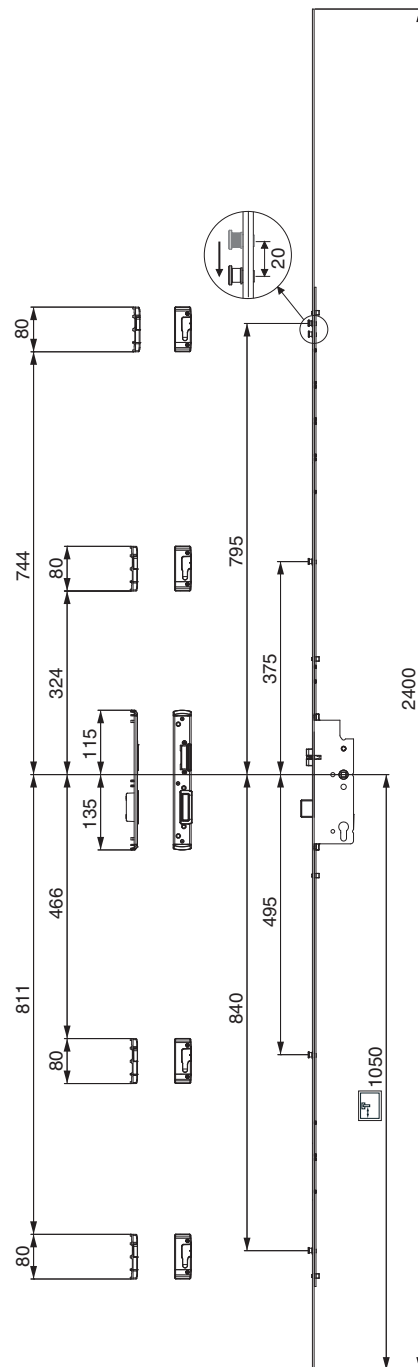











4.2 Door lock Z-TS Module with i.S.

4.2.1 Door lock Z-TS with 4 i.S.

Flat faceplate 16 mm

230694













4.2.1.1 Door lock Z-TS Module PT-M with 4 i.S. E92 F-16											
		92	25	8	1.050	1.950 - 2.400	16	2.400	5	No	
extendable without deadbolt	silver	30	8	1.050	1.950 - 2.400	16	2.400	5	234180		
		30	8	1.050	1.950 - 2.400	16	2.400	5	234181		
extendable	silver	35	8	1.050	1.950 - 2.400	16	2.400	5	230690		
			10	1.050	1.950 - 2.400	16	2.400	5	230020		
		40	8	1.050	1.950 - 2.400	16	2.400	5	230691		
			10	1.050	1.950 - 2.400	16	2.400	5	230021		
		45	8	1.050	1.950 - 2.400	16	2.400	5	230692		
			10	1.050	1.950 - 2.400	16	2.400	5	230022		
		50	8	1.050	1.950 - 2.400	16	2.400	5	230693		
			10	1.050	1.950 - 2.400	16	2.400	5	230023		
		55	8	1.050	1.950 - 2.400	16	2.400	5	230694		
			10	1.050	1.950 - 2.400	16	2.400	5	230024		
		65	8	1.050	1.950 - 2.400	16	2.400	5	230695		
			10	1.050	1.950 - 2.400	16	2.400	5	230025		
		70	8	1.050	1.950 - 2.400	16	2.400	5	230696		
			10	1.050	1.950 - 2.400	16	2.400	5	230026		
80	8	1.050	1.950 - 2.400	16	2.400	5	230697				
	10	1.050	1.950 - 2.400	16	2.400	5	230027				

Flat faceplate 20 mm

230764











4.2.1.2 Door lock Z-TS Module PT-M with 4 i.S. E92 F-20											
		92	25	8	1.050	1.950 - 2.400	20	2.400	5	No	
extendable without deadbolt	silver	30	8	1.050	1.950 - 2.400	20	2.400	5	234182		
		30	8	1.050	1.950 - 2.400	20	2.400	5	234183		
extendable	silver	35	8	1.050	1.950 - 2.400	20	2.400	5	230760		
			10	1.050	1.950 - 2.400	20	2.400	5	230260		
		40	8	1.050	1.950 - 2.400	20	2.400	5	230761		
			10	1.050	1.950 - 2.400	20	2.400	5	230261		
		45	8	1.050	1.950 - 2.400	20	2.400	5	230762		
			10	1.050	1.950 - 2.400	20	2.400	5	230262		
		50	8	1.050	1.950 - 2.400	20	2.400	5	230763		
			10	1.050	1.950 - 2.400	20	2.400	5	230263		
		55	8	1.050	1.950 - 2.400	20	2.400	5	230764		
			10	1.050	1.950 - 2.400	20	2.400	5	230264		
		65	8	1.050	1.950 - 2.400	20	2.400	5	230765		
			10	1.050	1.950 - 2.400	20	2.400	5	230265		
		70	8	1.050	1.950 - 2.400	20	2.400	5	230766		
			10	1.050	1.950 - 2.400	20	2.400	5	230266		
80	8	1.050	1.950 - 2.400	20	2.400	5	230767				
	10	1.050	1.950 - 2.400	20	2.400	5	230267				

Flat faceplate 24 mm

231244











4.2.1.3 Door lock Z-TS Module PT-M with 4 i.S. E92 F-24											
		L									No
extendable without deadbolt	silver	92	25	8	1.050	1.950 - 2.400	24	2.400	5		234184
			30	8	1.050	1.950 - 2.400	24	2.400	5		234185
extendable	silver	92	35	8	1.050	1.950 - 2.400	24	2.400	5		231240
				10	1.050	1.950 - 2.400	24	2.400	5		230930
			40	8	1.050	1.950 - 2.400	24	2.400	5		231241
				10	1.050	1.950 - 2.400	24	2.400	5		230931
			45	8	1.050	1.950 - 2.400	24	2.400	5		231242
				10	1.050	1.950 - 2.400	24	2.400	5		230932
			50	8	1.050	1.950 - 2.400	24	2.400	5		231243
				10	1.050	1.950 - 2.400	24	2.400	5		230933
			55	8	1.050	1.950 - 2.400	24	2.400	5		231244
				10	1.050	1.950 - 2.400	24	2.400	5		230934
			65	8	1.050	1.950 - 2.400	24	2.400	5		231245
				10	1.050	1.950 - 2.400	24	2.400	5		230935
70	8	1.050	1.950 - 2.400	24	2.400	5		231246			
	10	1.050	1.950 - 2.400	24	2.400	5		230936			
80	8	1.050	1.950 - 2.400	24	2.400	5		231247			
	10	1.050	1.950 - 2.400	24	2.400	5		230937			

4

Top hat faceplate 24/16 mm

237604









4.2.1.4 Door lock Z-TS Module PT-M with 4 i.S. E92 F-24/16											
		L									No
extendable	silver	92	35	8	1.050	1.950 - 2.400	24/16	2.400	5		237600
				10	1.050	1.950 - 2.400	24/16	2.400	5		237590
			40	8	1.050	1.950 - 2.400	24/16	2.400	5		237601
				10	1.050	1.950 - 2.400	24/16	2.400	5		237591
			45	8	1.050	1.950 - 2.400	24/16	2.400	5		237602
				10	1.050	1.950 - 2.400	24/16	2.400	5		237592
			50	8	1.050	1.950 - 2.400	24/16	2.400	5		237603
				10	1.050	1.950 - 2.400	24/16	2.400	5		237593
			55	8	1.050	1.950 - 2.400	24/16	2.400	5		237604
				10	1.050	1.950 - 2.400	24/16	2.400	5		237594
			65	8	1.050	1.950 - 2.400	24/16	2.400	5		237605
				10	1.050	1.950 - 2.400	24/16	2.400	5		237595
			70	8	1.050	1.950 - 2.400	24/16	2.400	5		237606
				10	1.050	1.950 - 2.400	24/16	2.400	5		237596
			80	8	1.050	1.950 - 2.400	24/16	2.400	5		237607
				10	1.050	1.950 - 2.400	24/16	2.400	5		237597

Flat faceplate 16 mm

230014









4.2.1.5 Door lock Z-TS Module PT-M with 4 i.S. E88 F-16									No	
extendable	silver	88	35	8,5	1.050	1.950 - 2.400	16	2.400	5	230010
			40	8,5	1.050	1.950 - 2.400	16	2.400	5	230011
			45	8,5	1.050	1.950 - 2.400	16	2.400	5	230012
			50	8,5	1.050	1.950 - 2.400	16	2.400	5	230013
			55	8,5	1.050	1.950 - 2.400	16	2.400	5	230014
			65	8,5	1.050	1.950 - 2.400	16	2.400	5	230015
			70	8,5	1.050	1.950 - 2.400	16	2.400	5	230016
			80	8,5	1.050	1.950 - 2.400	16	2.400	5	230017

Flat faceplate 20 mm

230254









4.2.1.6 Door lock Z-TS Module PT-M with 4 i.S. E88 F-20									No	
extendable	silver	88	35	8,5	1.050	1.950 - 2.400	20	2.400	5	230250
			40	8,5	1.050	1.950 - 2.400	20	2.400	5	230251
			45	8,5	1.050	1.950 - 2.400	20	2.400	5	230252
			50	8,5	1.050	1.950 - 2.400	20	2.400	5	230253
			55	8,5	1.050	1.950 - 2.400	20	2.400	5	230254
			65	8,5	1.050	1.950 - 2.400	20	2.400	5	230255
			70	8,5	1.050	1.950 - 2.400	20	2.400	5	230256
			80	8,5	1.050	1.950 - 2.400	20	2.400	5	230257

Flat faceplate 16 mm

236004









4.2.1.7 Door lock Z-TS Module PT-M with 4 i.S. E94 F-16									No	
extendable	silver	94	35	9	1.050	1.950 - 2.400	16	2.400	5	236000
			40	9	1.050	1.950 - 2.400	16	2.400	5	236001
			45	9	1.050	1.950 - 2.400	16	2.400	5	236002
			50	9	1.050	1.950 - 2.400	16	2.400	5	236003
			55	9	1.050	1.950 - 2.400	16	2.400	5	236004
			65	9	1.050	1.950 - 2.400	16	2.400	5	236005
			70	9	1.050	1.950 - 2.400	16	2.400	5	236006
			80	9	1.050	1.950 - 2.400	16	2.400	5	236007

Flat faceplate 20 mm

236034









4.2.1.8 Door lock Z-TS Module PT-M with 4 i.S. E94 F-20								L		No
extendable	silver	94	35	9	1.050	1.950 - 2.400	20	2.400	5	236030
			40	9	1.050	1.950 - 2.400	20	2.400	5	236031
			45	9	1.050	1.950 - 2.400	20	2.400	5	236032
			50	9	1.050	1.950 - 2.400	20	2.400	5	236033
			55	9	1.050	1.950 - 2.400	20	2.400	5	236034
			65	9	1.050	1.950 - 2.400	20	2.400	5	236035
			70	9	1.050	1.950 - 2.400	20	2.400	5	236036
			80	9	1.050	1.950 - 2.400	20	2.400	5	236037

4

Top hat faceplate 24/16 mm

237144



4.2.1.9 Door lock Z-TS Module PT-M with 4 i.S. E94 F-24/16								L		No
extendable	silver	94	35	9	1.050	1.950 - 2.400	24/16	2.400	5	237140
			40	9	1.050	1.950 - 2.400	24/16	2.400	5	237141
			45	9	1.050	1.950 - 2.400	24/16	2.400	5	237142
			50	9	1.050	1.950 - 2.400	24/16	2.400	5	237143
			55	9	1.050	1.950 - 2.400	24/16	2.400	5	237144
			65	9	1.050	1.950 - 2.400	24/16	2.400	5	237145
			70	9	1.050	1.950 - 2.400	24/16	2.400	5	237146
			80	9	1.050	1.950 - 2.400	24/16	2.400	5	237147

4.3 Door lock Z-TS Module with i.S. + ZS











4.3.1 Door lock Z-TS with 3 i.S. + ZS

Flat faceplate 16 mm

231424



4.3.1.1 Door lock Z-TS Module PT-M with 3 i.S. + ZS E92 F-16









											
extendable	silver	92	35	8	1.050	1.950 - 2.400	16	2.400	5		231420
				10	1.050	1.950 - 2.400	16	2.400	5		231430
				40	1.050	1.950 - 2.400	16	2.400	5		231421
				10	1.050	1.950 - 2.400	16	2.400	5		231431
				45	1.050	1.950 - 2.400	16	2.400	5		231422
				10	1.050	1.950 - 2.400	16	2.400	5		231432
				50	1.050	1.950 - 2.400	16	2.400	5		231423
				10	1.050	1.950 - 2.400	16	2.400	5		231433
				55	1.050	1.950 - 2.400	16	2.400	5		231424
				10	1.050	1.950 - 2.400	16	2.400	5		231434
				65	1.050	1.950 - 2.400	16	2.400	5		231425
				10	1.050	1.950 - 2.400	16	2.400	5		231435
				70	1.050	1.950 - 2.400	16	2.400	5		231426
				10	1.050	1.950 - 2.400	16	2.400	5		231436
				80	1.050	1.950 - 2.400	16	2.400	5		231427
				10	1.050	1.950 - 2.400	16	2.400	5		231437

Flat faceplate 20 mm

231464



4.3.1.2 Door lock Z-TS Module PT-M with 3 i.S. + ZS E92 F-20

											
extendable	silver	92	35	8	1.050	1.950 - 2.400	20	2.400	5		231460
				10	1.050	1.950 - 2.400	20	2.400	5		231470
				40	1.050	1.950 - 2.400	20	2.400	5		231461
				10	1.050	1.950 - 2.400	20	2.400	5		231471
				45	1.050	1.950 - 2.400	20	2.400	5		231462
				10	1.050	1.950 - 2.400	20	2.400	5		231472
				50	1.050	1.950 - 2.400	20	2.400	5		231463
				10	1.050	1.950 - 2.400	20	2.400	5		231473
				55	1.050	1.950 - 2.400	20	2.400	5		231464
				10	1.050	1.950 - 2.400	20	2.400	5		231474
				65	1.050	1.950 - 2.400	20	2.400	5		231465
				10	1.050	1.950 - 2.400	20	2.400	5		231475
				70	1.050	1.950 - 2.400	20	2.400	5		231466
				10	1.050	1.950 - 2.400	20	2.400	5		231476
				80	1.050	1.950 - 2.400	20	2.400	5		231467
				10	1.050	1.950 - 2.400	20	2.400	5		231477

4.4 Door lock Z-TS Module PT-M with 2 HO-BO + i.S.

4.4.1 Door lock Z-TS with 2HO-BO and 2i.S.

Flat faceplate 16 mm

238564



4.4.1.1 Door lock Z-TS Module PT-M with 2 HO-BO and 2i.S. E92 F-16



modular	silver	92	35	8	1.050	1.950 - 2.400	16	2.400	5	No
				10	1.050	1.950 - 2.400	16	2.400	5	238560
			40	8	1.050	1.950 - 2.400	16	2.400	5	238561
				10	1.050	1.950 - 2.400	16	2.400	5	238571
			45	8	1.050	1.950 - 2.400	16	2.400	5	238562
				10	1.050	1.950 - 2.400	16	2.400	5	238572
			50	8	1.050	1.950 - 2.400	16	2.400	5	238563
				10	1.050	1.950 - 2.400	16	2.400	5	238573
			55	8	1.050	1.950 - 2.400	16	2.400	5	238564
				10	1.050	1.950 - 2.400	16	2.400	5	238574
			65	8	1.050	1.950 - 2.400	16	2.400	5	238565
				10	1.050	1.950 - 2.400	16	2.400	5	238575
			70	8	1.050	1.950 - 2.400	16	2.400	5	238566
				10	1.050	1.950 - 2.400	16	2.400	5	238576
			80	8	1.050	1.950 - 2.400	16	2.400	5	238567
				10	1.050	1.950 - 2.400	16	2.400	5	238577

Flat faceplate 20 mm

238714



4.4.1.2 Door lock Z-TS Module PT-M with 2 HO-BO + 2i.S. E92 F-20



modular	silver	92	35	8	1.050	1.950 - 2.400	20	2.400	5	No
				10	1.050	1.950 - 2.400	20	2.400	5	238710
			40	8	1.050	1.950 - 2.400	20	2.400	5	238711
				10	1.050	1.950 - 2.400	20	2.400	5	238721
			45	8	1.050	1.950 - 2.400	20	2.400	5	238712
				10	1.050	1.950 - 2.400	20	2.400	5	238722
			50	8	1.050	1.950 - 2.400	20	2.400	5	238713
				10	1.050	1.950 - 2.400	20	2.400	5	238723
			55	8	1.050	1.950 - 2.400	20	2.400	5	238714
				10	1.050	1.950 - 2.400	20	2.400	5	238724
			65	8	1.050	1.950 - 2.400	20	2.400	5	238715
				10	1.050	1.950 - 2.400	20	2.400	5	238725
			70	8	1.050	1.950 - 2.400	20	2.400	5	238716
				10	1.050	1.950 - 2.400	20	2.400	5	238726
			80	8	1.050	1.950 - 2.400	20	2.400	5	238717
				10	1.050	1.950 - 2.400	20	2.400	5	238727

4.5 Door lock Z-TS Module PT-M with HO-BO







4.5.1 Door lock Z-TS with 2HO-BO

Flat faceplate 16 mm

235814



4.5.1.1 Door lock Z-TS Module PT-M with 2 HO-BO E92 F-16







								L		No
modular	silver	92	35	8	1.050	1.950 - 2.400	16	2.400	5	235810
				10	1.050	1.950 - 2.400	16	2.400	5	235820
			40	8	1.050	1.950 - 2.400	16	2.400	5	235811
				10	1.050	1.950 - 2.400	16	2.400	5	235821
			45	8	1.050	1.950 - 2.400	16	2.400	5	235812
				10	1.050	1.950 - 2.400	16	2.400	5	235822
			50	8	1.050	1.950 - 2.400	16	2.400	5	235813
				10	1.050	1.950 - 2.400	16	2.400	5	235823
			55	8	1.050	1.950 - 2.400	16	2.400	5	235814
				10	1.050	1.950 - 2.400	16	2.400	5	235824
			65	8	1.050	1.950 - 2.400	16	2.400	5	235815
				10	1.050	1.950 - 2.400	16	2.400	5	235825
			70	8	1.050	1.950 - 2.400	16	2.400	5	235816
				10	1.050	1.950 - 2.400	16	2.400	5	235826
			80	8	1.050	1.950 - 2.400	16	2.400	5	235817
				10	1.050	1.950 - 2.400	16	2.400	5	235827

Flat faceplate 20 mm

235854









4.5.1.2 Door lock Z-TS Module PT-M with 2 HO-BO E92 F-20

								L		No
modular	silver	92	35	8	1.050	1.900 - 2.400	20	2.400	5	235850
				10	1.050	1.900 - 2.400	20	2.400	5	235860
			40	8	1.050	1.900 - 2.400	20	2.400	5	235851
				10	1.050	1.900 - 2.400	20	2.400	5	235861
			45	8	1.050	1.900 - 2.400	20	2.400	5	235852
				10	1.050	1.900 - 2.400	20	2.400	5	235862
			50	8	1.050	1.900 - 2.400	20	2.400	5	235853
				10	1.050	1.900 - 2.400	20	2.400	5	235863
			55	8	1.050	1.900 - 2.400	20	2.400	5	235854
				10	1.050	1.900 - 2.400	20	2.400	5	235864
			65	8	1.050	1.900 - 2.400	20	2.400	5	235855
				10	1.050	1.900 - 2.400	20	2.400	5	235865
			70	8	1.050	1.900 - 2.400	20	2.400	5	235856
				10	1.050	1.900 - 2.400	20	2.400	5	235866
			80	8	1.050	1.900 - 2.400	20	2.400	5	235857
				10	1.050	1.900 - 2.400	20	2.400	5	235867

Flat faceplate 24 mm

235894









4.5.1.3 Door lock Z-TS Module PT-M with 2 HO-BO E92 F-24								L		No
modular	silver	92	35	8	1.050	1.950 - 2.400	24	2.400	5	235890
				10	1.050	1.950 - 2.400	24	2.400	5	235900
			40	8	1.050	1.950 - 2.400	24	2.400	5	235891
				10	1.050	1.950 - 2.400	24	2.400	5	235901
			45	8	1.050	1.950 - 2.400	24	2.400	5	235892
				10	1.050	1.950 - 2.400	24	2.400	5	235902
			50	8	1.050	1.950 - 2.400	24	2.400	5	235893
				10	1.050	1.950 - 2.400	24	2.400	5	235903
			55	8	1.050	1.950 - 2.400	24	2.400	5	235894
				10	1.050	1.950 - 2.400	24	2.400	5	235904
			65	8	1.050	1.950 - 2.400	24	2.400	5	235895
				10	1.050	1.950 - 2.400	24	2.400	5	235905
			70	8	1.050	1.950 - 2.400	24	2.400	5	235896
				10	1.050	1.950 - 2.400	24	2.400	5	235906
			80	8	1.050	1.950 - 2.400	24	2.400	5	235897
				10	1.050	1.950 - 2.400	24	2.400	5	235907

4

Top hat faceplate 24/16 mm









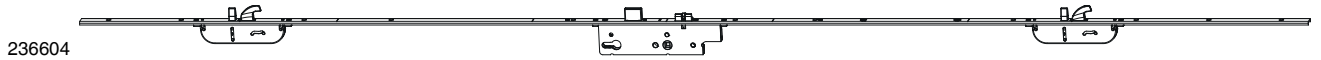

237624











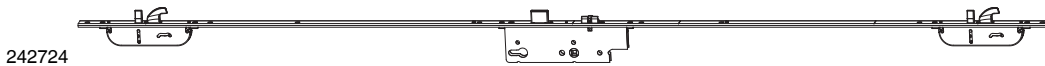



4.5.1.4 Door lock Z-TS Module PT-M with 2 HO-BO E92 F-24/16							L		No	
modular	silver	92	35	8	1.050	1.950 - 2.400	24/16	2.400	5	237620
				10	1.050	1.950 - 2.400	24/16	2.400	5	237630
			40	8	1.050	1.950 - 2.400	24/16	2.400	5	237621
				10	1.050	1.950 - 2.400	24/16	2.400	5	237631
			45	8	1.050	1.950 - 2.400	24/16	2.400	5	237622
				10	1.050	1.900 - 2.400	24/16	2.400	5	237632
			50	8	1.050	1.950 - 2.400	24/16	2.400	5	237623
				10	1.050	1.950 - 2.400	24/16	2.400	5	237633
			55	8	1.050	1.950 - 2.400	24/16	2.400	5	237624
				10	1.050	1.950 - 2.400	24/16	2.400	5	237634
			65	8	1.050	1.950 - 2.400	24/16	2.400	5	237625
				10	1.050	1.950 - 2.400	24/16	2.400	5	237635
			70	8	1.050	1.950 - 2.400	24/16	2.400	5	237626
				10	1.050	1.950 - 2.400	24/16	2.400	5	237636
			80	8	1.050	1.950 - 2.400	24/16	2.400	5	237627
				10	1.050	1.950 - 2.400	24/16	2.400	5	237637

U-faceplate 6x24x6 mm









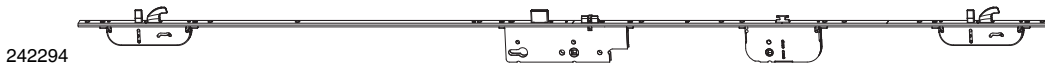



4.5.1.5 Door lock Z-TS Module PT-M with 2 HO-BO E92 U-6x24x6												
		L									No	
modular	silver	92	35	8	1.050	1.950 - 2.200	24	2.200	5	236600		
				10	1.050	1.950 - 2.200	24	2.200	5	236590		
		40	8	1.050	1.950 - 2.200	24	2.200	5	236601			
			10	1.050	1.950 - 2.200	24	2.200	5	236591			
		45	8	1.050	1.950 - 2.200	24	2.200	5	236602			
			10	1.050	1.950 - 2.200	24	2.200	5	236592			
		50	8	1.050	1.950 - 2.200	24	2.200	5	236603			
			10	1.050	1.950 - 2.200	24	2.200	5	236593			
		55	8	1.050	1.950 - 2.200	24	2.200	5	236604			
			10	1.050	1.950 - 2.200	24	2.200	5	236594			
		65	8	1.050	1.950 - 2.200	24	2.200	5	236605			
			10	1.050	1.950 - 2.200	24	2.200	5	236595			
		70	8	1.050	1.950 - 2.200	24	2.200	5	236606			
			10	1.050	1.950 - 2.200	24	2.200	5	236596			
		80	8	1.050	1.950 - 2.200	24	2.200	5	236607			
			10	1.050	1.950 - 2.200	24	2.200	5	236597			



4.5.1.6 Door lock Z-TS Module PT-M with 2 HO-BO E92 U-6x24x6 HH885												
		L									No	
modular	silver	92	35	8	885	1.500 - 1.800	24	1.740	5	242720		
				10	885	1.500 - 1.800	24	1.740	5	242730		
		40	8	885	1.500 - 1.800	24	1.740	5	242721			
			10	885	1.500 - 1.800	24	1.740	5	242731			
		45	8	885	1.500 - 1.800	24	1.740	5	242722			
			10	885	1.500 - 1.800	24	1.740	5	242732			
		50	8	885	1.500 - 1.800	24	1.740	5	242723			
			10	885	1.500 - 1.800	24	1.740	5	242733			
		55	8	885	1.500 - 1.800	24	1.740	5	242724			
			10	885	1.500 - 1.800	24	1.740	5	242734			



4.5.1.7 Door lock Z-TS Module PT-M with 2 HO-BO E92 U-6x24x6 HH885 and door turn-restrictor												
		L									No	
fixed handle height	silver	92	35	8	885	2.000 - 2.200	24	1.740	5	242290		
				10	885	2.000 - 2.200	24	1.740	5	242300		
		40	8	885	2.000 - 2.200	24	1.740	5	242291			
			10	885	2.000 - 2.200	24	1.740	5	242301			
		45	8	885	2.000 - 2.200	24	1.740	5	242292			
			10	885	2.000 - 2.200	24	1.740	5	242302			
		50	8	885	2.000 - 2.200	24	1.740	5	242293			
			10	885	2.000 - 2.200	24	1.740	5	242303			
		55	8	885	2.000 - 2.200	24	1.740	5	242294			
			10	885	2.000 - 2.200	24	1.740	5	242304			



242114

4.5.1.8 Door lock Z-TS Module PT-M with 2 HO-BO E92 U-6x24x6 K+375 HH885								L		No
fixed handle height	silver	92	35	8	885	1.500 - 1.800	24	1.385	5	242110
				10	885	1.500 - 1.800	24	1.385	5	242120
			40	8	885	1.500 - 1.800	24	1.385	5	242111
				10	885	1.500 - 1.800	24	1.385	5	242121
			45	8	885	1.500 - 1.800	24	1.385	5	242112
				10	885	1.500 - 1.800	24	1.385	5	242122
		50	8	885	1.500 - 1.800	24	1.385	5	242113	
			10	885	1.500 - 1.800	24	1.385	5	242123	
		55	8	885	1.500 - 1.800	24	1.385	5	242114	
			10	885	1.500 - 1.800	24	1.385	5	242124	

4

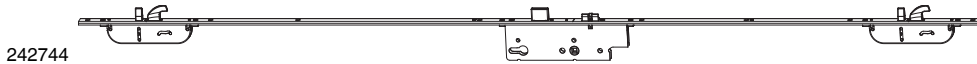

242744

4.5.1.9 Door lock Z-TS Module PT-M with 2 HO-BO E92 U-6x24x6 K+605 HH885								L		No
fixed handle height	silver	92	35	8	885	1.800 - 2.000	24	1.615	5	242740
				10	885	1.800 - 2.000	24	1.615	5	242750
			40	8	885	1.800 - 2.000	24	1.615	5	242741
				10	885	1.800 - 2.000	24	1.615	5	242751
			45	8	885	1.800 - 2.000	24	1.615	5	242742
				10	885	1.800 - 2.000	24	1.615	5	242752
		50	8	885	1.800 - 2.000	24	1.615	5	242743	
			10	885	1.800 - 2.000	24	1.615	5	242753	
		55	8	885	1.800 - 2.000	24	1.615	5	242744	
			10	885	1.800 - 2.000	24	1.615	5	242754	

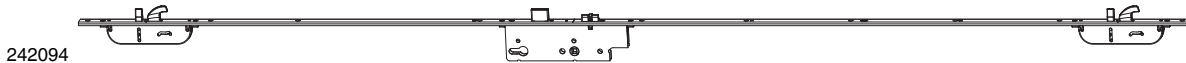













242094

4.5.1.10 Door lock Z-TS Module PT-M with 2 HO-BO E92 U-6x24x6 K+980 HH885								L		No
fixed handle height	silver	92	35	8	885	2.200 - 2.400	24	1.990	5	242090
				10	885	2.200 - 2.400	24	1.990	5	242100
			40	8	885	2.200 - 2.400	24	1.990	5	242091
				10	885	2.200 - 2.400	24	1.990	5	242101
			45	8	885	2.200 - 2.400	24	1.990	5	242092
				10	885	2.200 - 2.400	24	1.990	5	242102
		50	8	885	2.200 - 2.400	24	1.990	5	242093	
			10	885	2.200 - 2.400	24	1.990	5	242103	
		55	8	885	2.200 - 2.400	24	1.990	5	242094	
			10	885	2.200 - 2.400	24	1.990	5	242104	

Flat faceplate 16 mm

235804















4.5.1.11 Door lock Z-TS Module PT-M with 2 HO-BO E88 F-16														
modular	silver	88												No
			35	8,5	1.050	1.950 - 2.400	16	2.400	5					235800
			40	8,5	1.050	1.950 - 2.400	16	2.400	5					235801
			45	8,5	1.050	1.950 - 2.400	16	2.400	5					235802
			50	8,5	1.050	1.950 - 2.400	16	2.400	5					235803
			55	8,5	1.050	1.950 - 2.400	16	2.400	5					235804
			65	8,5	1.050	1.950 - 2.400	16	2.400	5					235805
			70	8,5	1.050	1.950 - 2.400	16	2.400	5					235806
			80	8,5	1.050	1.950 - 2.400	16	2.400	5					235807

Flat faceplate 20 mm

235844















4.5.1.12 Door lock Z-TS Module PT-M with 2 HO-BO E88 F-20														
modular	silver	88												No
			35	8,5	1.050	1.950 - 2.400	20	2.400	5					235840
			40	8,5	1.050	1.950 - 2.400	20	2.400	5					235841
			45	8,5	1.050	1.950 - 2.400	20	2.400	5					235842
			50	8,5	1.050	1.950 - 2.400	20	2.400	5					235843
			55	8,5	1.050	1.950 - 2.400	20	2.400	5					235844
			65	8,5	1.050	1.950 - 2.400	20	2.400	5					235845
			70	8,5	1.050	1.950 - 2.400	20	2.400	5					235846
			80	8,5	1.050	1.950 - 2.400	20	2.400	5					235847

Flat faceplate 16 mm

236014



4.5.1.13 Door lock Z-TS Module PT-M with 2 HO-BO E94 F-16														
modular	silver	94												No
			35	9	1.050	1.950 - 2.400	16	2.400	5					236010
			40	9	1.050	1.950 - 2.400	16	2.400	5					236011
			45	9	1.050	1.950 - 2.400	16	2.400	5					236012
			50	9	1.050	1.950 - 2.400	16	2.400	5					236013
			55	9	1.050	1.950 - 2.400	16	2.400	5					236014
			65	9	1.050	1.950 - 2.400	16	2.400	5					236015
			70	9	1.050	1.950 - 2.400	16	2.400	5					236016
			80	9	1.050	1.950 - 2.400	16	2.400	5					236017

Flat faceplate 20 mm

236024



4.5.1.14 Door lock Z-TS Module PT-M with 2 HO-BO E94 F-20

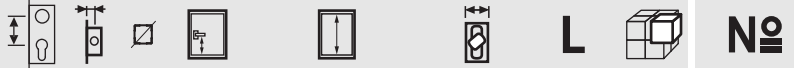

modular	silver	94	35	9	1.050	1.950 - 2.400	20	2.400	5	No
			40	9	1.050	1.950 - 2.400	20	2.400	5	236020
			45	9	1.050	1.950 - 2.400	20	2.400	5	236021
			50	9	1.050	1.950 - 2.400	20	2.400	5	236022
			55	9	1.050	1.950 - 2.400	20	2.400	5	236023
			65	9	1.050	1.950 - 2.400	20	2.400	5	236024
			70	9	1.050	1.950 - 2.400	20	2.400	5	236025
			80	9	1.050	1.950 - 2.400	20	2.400	5	236026
										236027

Top hat faceplate 24/16 mm

240464



4.5.1.15 Door lock Z-TS Module PT-M with 2 HO-BO E94 F-24/16

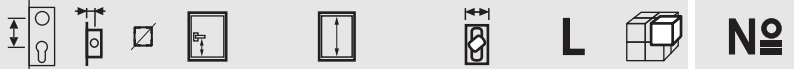

modular	silver	94	35	9	1.050	1.900 - 2.400	24/16	2.400	5	No
			40	9	1.050	1.900 - 2.400	24/16	2.400	5	240460
			45	9	1.050	1.900 - 2.400	24/16	2.400	5	240461
			50	9	1.050	1.900 - 2.400	24/16	2.400	5	240462
			55	9	1.050	1.900 - 2.400	24/16	2.400	5	240463
			65	9	1.050	1.900 - 2.400	24/16	2.400	5	240464
			70	9	1.050	1.900 - 2.400	24/16	2.400	5	240465
			80	9	1.050	1.900 - 2.400	24/16	2.400	5	240466
										240467

U-faceplate 6x24x6 mm

238462

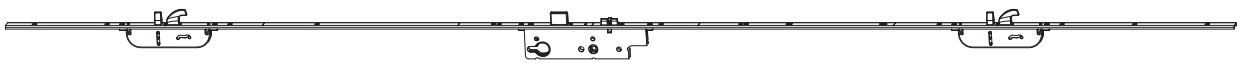

4.5.1.16 Door lock Z-TS Module PT-M with 2 HO-BO E94 U-6x24x6

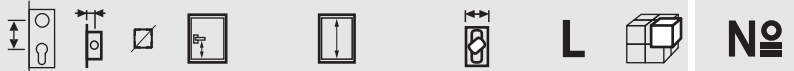







modular	silver	94	45	9	1.050	1.950 - 2.200	24	2.200	5	No
										238462

4.5.2 Door lock Z-TS with 4 HO-BO

Flat faceplate 16 mm

234004









4.5.2.1 Door lock Z-TS Module PT-M with 4 HO-BO E92 F-16								L		No
modular	silver	92	35	8	1.050	1.950 - 2.400	16	2.400	5	234000
				10	1.050	1.950 - 2.400	16	2.400	5	233990
			40	8	1.050	1.950 - 2.400	16	2.400	5	234001
				10	1.050	1.950 - 2.400	16	2.400	5	233991
			45	8	1.050	1.950 - 2.400	16	2.400	5	234002
				10	1.050	1.950 - 2.400	16	2.400	5	233992
			50	8	1.050	1.950 - 2.400	16	2.400	5	234003
				10	1.050	1.950 - 2.400	16	2.400	5	233993
			55	8	1.050	1.950 - 2.400	16	2.400	5	234004
				10	1.050	1.950 - 2.400	16	2.400	5	233994
			65	8	1.050	1.950 - 2.400	16	2.400	5	234005
				10	1.050	1.950 - 2.400	16	2.400	5	233995
			70	8	1.050	1.950 - 2.400	16	2.400	5	234006
				10	1.050	1.950 - 2.400	16	2.400	5	233996
			80	8	1.050	1.950 - 2.400	16	2.400	5	234007
				10	1.050	1.950 - 2.400	16	2.400	5	233997

Flat faceplate 20 mm

235124









4.5.2.2 Door lock Z-TS Module PT-M with 4 HO-BO E92 F-20								L		No
modular	silver	92	35	8	1.050	1.950 - 2.400	20	2.400	5	235120
				10	1.050	1.950 - 2.400	20	2.400	5	235110
			40	8	1.050	1.950 - 2.400	20	2.400	5	235121
				10	1.050	1.950 - 2.400	20	2.400	5	235111
			45	8	1.050	1.950 - 2.400	20	2.400	5	235122
				10	1.050	1.950 - 2.400	20	2.400	5	235112
			50	8	1.050	1.950 - 2.400	20	2.400	5	235123
				10	1.050	1.950 - 2.400	20	2.400	5	235113
			55	8	1.050	1.950 - 2.400	20	2.400	5	235124
				10	1.050	1.950 - 2.400	20	2.400	5	235114
			65	8	1.050	1.950 - 2.400	20	2.400	5	235125
				10	1.050	1.950 - 2.400	20	2.400	5	235115
			70	8	1.050	1.950 - 2.400	20	2.400	5	235126
				10	1.050	1.950 - 2.400	20	2.400	5	235116
			80	8	1.050	1.950 - 2.400	20	2.400	5	235127
				10	1.050	1.950 - 2.400	20	2.400	5	235117

Flat faceplate 24 mm

234814









4.5.2.3 Door lock Z-TS Module PT-M with 4 HO-BO E92 F-24								L		No
modular	silver	92	35	8	1.050	1.950 - 2.400	24	2.400	5	234810
				10	1.050	1.950 - 2.400	24	2.400	5	234800
		40	8	1.050	1.950 - 2.400	24	2.400	5	234811	
			10	1.050	1.950 - 2.400	24	2.400	5	234801	
		45	8	1.050	1.950 - 2.400	24	2.400	5	234812	
			10	1.050	1.950 - 2.400	24	2.400	5	234802	
		50	8	1.050	1.950 - 2.400	24	2.400	5	234813	
			10	1.050	1.950 - 2.400	24	2.400	5	234803	
		55	8	1.050	1.950 - 2.400	24	2.400	5	234814	
			10	1.050	1.950 - 2.400	24	2.400	5	234804	
		65	8	1.050	1.950 - 2.400	24	2.400	5	234815	
			10	1.050	1.950 - 2.400	24	2.400	5	234805	
		70	8	1.050	1.950 - 2.400	24	2.400	5	234816	
			10	1.050	1.950 - 2.400	24	2.400	5	234806	
		80	8	1.050	1.950 - 2.400	24	2.400	5	234817	
			10	1.050	1.950 - 2.400	24	2.400	5	234807	

Top hat faceplate 24/16 mm

239514



4.5.2.4 Door lock Z-TS Module PT-M with 4 HO-BO E92 F-24/16							L		No	
silver		92	35	8	1.050	1.950 - 2.400	24/16	2.400	5	239510
				10	1.050	1.950 - 2.400	24/16	2.400	5	239520
		40	8	1.050	1.950 - 2.400	24/16	2.400	5	239511	
			10	1.050	1.950 - 2.400	24/16	2.400	5	239521	
		45	8	1.050	1.950 - 2.400	24/16	2.400	5	239512	
			10	1.050	1.950 - 2.400	24/16	2.400	5	239522	
		50	8	1.050	1.950 - 2.400	24/16	2.400	5	239513	
			10	1.050	1.950 - 2.400	24/16	2.400	5	239523	
		55	8	1.050	1.950 - 2.400	24/16	2.400	5	239514	
			10	1.050	1.950 - 2.400	24/16	2.400	5	239524	
		65	8	1.050	1.950 - 2.400	24/16	2.400	5	239515	
			10	1.050	1.950 - 2.400	24/16	2.400	5	239525	
		70	8	1.050	1.950 - 2.400	24/16	2.400	5	239516	
			10	1.050	1.950 - 2.400	24/16	2.400	5	239526	
		80	8	1.050	1.950 - 2.400	24/16	2.400	5	239517	
			10	1.050	1.950 - 2.400	24/16	2.400	5	239527	

U-faceplate 6x24x6 mm

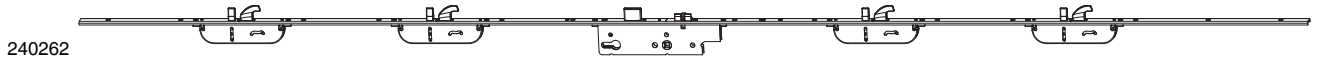

240262

4.5.2.5 Door lock Z-TS Module PT-M with 4 HO-BO E92 U-6x24x6 HH 1050



fixed handle height	silver	92	35	8	1.050	1.950 - 2.400	24	2.200	5	No
				10	1.050	1.950 - 2.200	24	2.200	5	240260
			40	8	1.050	1.950 - 2.400	24	2.200	5	240261
				10	1.050	1.950 - 2.200	24	2.200	5	240271
			45	8	1.050	1.950 - 2.400	24	2.200	5	240262
				10	1.050	1.950 - 2.200	24	2.200	5	240272



242474

4.5.2.6 Door lock Z-TS Module PT-M with 4 HO-BO E85 U-6x24x6 HH885



fixed handle height	silver	92	35	8	885	1.950 - 2.400	24	1.740	5	No
				10	885	1.950 - 2.400	24	1.740	5	242470
			40	8	885	1.950 - 2.400	24	1.740	5	242471
				10	885	1.950 - 2.400	24	1.740	5	242481
			45	8	885	1.950 - 2.400	24	1.740	5	242472
				10	885	1.950 - 2.400	24	1.740	5	242482
			50	8	885	1.950 - 2.400	24	1.740	5	242473
				10	885	1.950 - 2.400	24	1.740	5	242483
			55	8	885	1.950 - 2.400	24	1.740	5	242474
				10	885	1.950 - 2.400	24	1.740	5	242484

Flat faceplate 16 mm

236054



4.5.2.7 Door lock Z-TS Module PT-M with 4 HO-BO E94 F-16



modular	silver	94	35	9	1.050	1.950 - 2.400	16	2.400	5	No
			40	9	1.050	1.950 - 2.400	16	2.400	5	236050
			45	9	1.050	1.950 - 2.400	16	2.400	5	236051
			50	9	1.050	1.950 - 2.400	16	2.400	5	236052
			55	9	1.050	1.950 - 2.400	16	2.400	5	236053
			65	9	1.050	1.950 - 2.400	16	2.400	5	236054
			70	9	1.050	1.900 - 2.400	16	2.400	5	236055
			80	9	1.050	1.900 - 2.400	16	2.400	5	236056
										236057

Flat faceplate 20 mm

236074



4.5.2.8 Door lock Z-TS Module PT-M with 4 HO-BO E94 F-20



		94	35	9	1.050	1.950 - 2.400	20	L	5	No
modular	silver							2.400	5	236070
			40	9	1.050	1.950 - 2.400	20	2.400	5	236071
			45	9	1.050	1.950 - 2.400	20	2.400	5	236072
			50	9	1.050	1.950 - 2.400	20	2.400	5	236073
			55	9	1.050	1.900 - 2.400	20	2.400	5	236074
			65	9	1.050	1.900 - 2.400	20	2.400	5	236075
			70	9	1.050	1.900 - 2.400	20	2.400	5	236076
			80	9	1.050	1.900 - 2.400	20	2.400	5	236077

4

4.6 Door lock Z-TS Module with hook-bolt + ZS











4.6.1 Door lock Z-TS with 2 HO-BO + ZS

Flat faceplate 16 mm

234044



4.6.1.1 Door lock Z-TS Module PT-M with 2 HO-BO + ZS E92 F-16











												
		L										No
modular	silver	92	35	8	1.050	1.950 - 2.400	16	2.400	5			234040
				10	1.050	1.950 - 2.400	16	2.400	5	234030		
			40	8	1.050	1.950 - 2.400	16	2.400	5			234041
				10	1.050	1.950 - 2.400	16	2.400	5	234031		
			45	8	1.050	1.950 - 2.400	16	2.400	5			234042
				10	1.050	1.950 - 2.400	16	2.400	5	234032		
			50	8	1.050	1.950 - 2.400	16	2.400	5			234043
				10	1.050	1.950 - 2.400	16	2.400	5	234033		
			55	8	1.050	1.950 - 2.400	16	2.400	5			234044
				10	1.050	1.950 - 2.400	16	2.400	5	234034		
			65	8	1.050	1.950 - 2.400	16	2.400	5			234045
				10	1.050	1.950 - 2.400	16	2.400	5	234035		
			70	8	1.050	1.950 - 2.400	16	2.400	5			234046
				10	1.050	1.950 - 2.400	16	2.400	5	234036		
			80	8	1.050	1.950 - 2.400	16	2.400	5			234047
				10	1.050	1.950 - 2.400	16	2.400	5	234037		

Flat faceplate 20 mm

235164



4.6.1.2 Door lock Z-TS Module PT-M with 2 HO-BO + ZS E92 F-20

												
		L										No
modular	silver	92	35	8	1.050	1.950 - 2.400	20	2.400	5			235160
				10	1.050	1.950 - 2.400	20	2.400	5	235150		
			40	8	1.050	1.950 - 2.400	20	2.400	5			235161
				10	1.050	1.950 - 2.400	20	2.400	5	235151		
			45	8	1.050	1.950 - 2.400	20	2.400	5			235162
				10	1.050	1.950 - 2.400	20	2.400	5	235152		
			50	8	1.050	1.950 - 2.400	20	2.400	5			235163
				10	1.050	1.950 - 2.400	20	2.400	5	235153		
			55	8	1.050	1.950 - 2.400	20	2.400	5			235164
				10	1.050	1.950 - 2.400	20	2.400	5	235154		
			65	8	1.050	1.950 - 2.400	20	2.400	5			235165
				10	1.050	1.950 - 2.400	20	2.400	5	235155		
			70	8	1.050	1.950 - 2.400	20	2.400	5			235166
				10	1.050	1.950 - 2.400	20	2.400	5	235156		
			80	8	1.050	1.950 - 2.400	20	2.400	5			235167
				10	1.050	1.950 - 2.400	20	2.400	5	235157		

4.7 Door lock Z-TS Module with HO + i.S.







4.7.1 Door lock Z-TS with 2 HO and 2i.S.

Flat faceplate 16 mm

238664



4.7.1.1 Door lock Z-TS Module PT-M with 2 HO + 2i.S. E92 F-16







								L		No
modular	silver	92	35	8	1.050	1.950 - 2.400	16	2.400	5	238660
				10	1.050	1.950 - 2.400	16	2.400	5	238670
		40	8	1.050	1.950 - 2.400	16	2.400	5	238661	
				10	1.050	1.950 - 2.400	16	2.400	5	238671
		45	8	1.050	1.950 - 2.400	16	2.400	5	238662	
				10	1.050	1.950 - 2.400	16	2.400	5	238672
		50	8	1.050	1.950 - 2.400	16	2.400	5	238663	
				10	1.050	1.950 - 2.400	16	2.400	5	238673
		55	8	1.050	1.950 - 2.400	16	2.400	5	238664	
				10	1.050	1.950 - 2.400	16	2.400	5	238674
		65	8	1.050	1.950 - 2.400	16	2.400	5	238665	
				10	1.050	1.950 - 2.400	16	2.400	5	238675
		70	8	1.050	1.950 - 2.400	16	2.400	5	238666	
				10	1.050	1.950 - 2.400	16	2.400	5	238676
		80	8	1.050	1.950 - 2.400	16	2.400	5	238667	
				10	1.050	1.950 - 2.400	16	2.400	5	238677

Flat faceplate 20 mm

238814



4.7.1.2 Door lock Z-TS Module PT-M with 2 HO + 2i.S. E92 F-16

								L		No
modular	silver	92	35	8	1.050	1.950 - 2.400	20	2.400	5	238810
				10	1.050	1.950 - 2.400	20	2.400	5	238820
		40	8	1.050	1.950 - 2.400	20	2.400	5	238811	
				10	1.050	1.950 - 2.400	20	2.400	5	238821
		45	8	1.050	1.950 - 2.400	20	2.400	5	238812	
				10	1.050	1.950 - 2.400	20	2.400	5	238822
		50	8	1.050	1.950 - 2.400	20	2.400	5	238813	
				10	1.050	1.950 - 2.400	20	2.400	5	238823
		55	8	1.050	1.950 - 2.400	20	2.400	5	238814	
				10	1.050	1.950 - 2.400	20	2.400	5	238824
		65	8	1.050	1.950 - 2.400	20	2.400	5	238815	
				10	1.050	1.950 - 2.400	20	2.400	5	238825
		70	8	1.050	1.950 - 2.400	20	2.400	5	238816	
				10	1.050	1.950 - 2.400	20	2.400	5	238826
		80	8	1.050	1.950 - 2.400	20	2.400	5	238817	
				10	1.050	1.950 - 2.400	20	2.400	5	238827

4.8 Door lock Z-TS Module with HO







4.8.1 Door lock Z-TS with 2 HO

Flat faceplate 16 mm

238354









4.8.1.1 Door lock Z-TS Module PT-M with 2 HO E92 F-16

										L		No
modular	silver	92	35	8	1.050	1.950 - 2.400	16	2.400	5			238350
				10	1.050	1.950 - 2.400	16	2.400	5			238360
			40	8	1.050	1.950 - 2.400	16	2.400	5			238351
				10	1.050	1.950 - 2.400	16	2.400	5			238361
			45	8	1.050	1.950 - 2.400	16	2.400	5			238352
				10	1.050	1.950 - 2.400	16	2.400	5			238362
			50	8	1.050	1.950 - 2.400	16	2.400	5			238353
				10	1.050	1.950 - 2.400	16	2.400	5			238363
			55	8	1.050	1.950 - 2.400	16	2.400	5			238354
				10	1.050	1.950 - 2.400	16	2.400	5			238364
			65	8	1.050	1.950 - 2.400	16	2.400	5			238355
				10	1.050	1.950 - 2.400	16	2.400	5			238365
			70	8	1.050	1.950 - 2.400	16	2.400	5			238356
				10	1.050	1.950 - 2.400	16	2.400	5			238366
			80	8	1.050	1.950 - 2.400	16	2.400	5			238357
				10	1.050	1.950 - 2.400	16	2.400	5			238367

234624















4.8.1.2 Door lock Z-TS Module PT-M with 2 HO + ZS E92 F-16

										L		No
modular	silver	92	35	8	1.050	1.950 - 2.400	16	2.400	5			234620
				10	1.050	1.950 - 2.400	16	2.400	5			234290
			40	8	1.050	1.950 - 2.400	16	2.400	5			234621
				10	1.050	1.950 - 2.400	16	2.400	5			234291
			45	8	1.050	1.950 - 2.400	16	2.400	5			234622
				10	1.050	1.950 - 2.400	16	2.400	5			234292
			50	8	1.050	1.950 - 2.400	16	2.400	5			234623
				10	1.050	1.950 - 2.400	16	2.400	5			234293
			55	8	1.050	1.950 - 2.400	16	2.400	5			234624
				10	1.050	1.950 - 2.400	16	2.400	5			234294
			65	8	1.050	1.950 - 2.400	16	2.400	5			234625
				10	1.050	1.950 - 2.400	16	2.400	5			234295
			70	8	1.050	1.950 - 2.400	16	2.400	5			234626
				10	1.050	1.950 - 2.400	16	2.400	5			234296
			80	8	1.050	1.950 - 2.400	16	2.400	5			234627
				10	1.050	1.950 - 2.400	16	2.400	5			234297

Flat faceplate 20 mm

234324















4.8.1.3 Door lock Z-TS Module PT-M with 2 HO E92 F-20															
		L												No	
modular	silver	92	35	8	1.050	1.950 - 2.400	20	2.400	5					234320	
			10	1.050	1.950 - 2.400	20	2.400	5						234330	
		40	8	1.050	1.950 - 2.400	20	2.400	5							234321
			10	1.050	1.950 - 2.400	20	2.400	5							234331
		45	8	1.050	1.950 - 2.400	20	2.400	5							234322
			10	1.050	1.950 - 2.400	20	2.400	5							234332
		50	8	1.050	1.950 - 2.400	20	2.400	5							234323
			10	1.050	1.950 - 2.400	20	2.400	5							234333
		55	8	1.050	1.950 - 2.400	20	2.400	5							234324
			10	1.050	1.950 - 2.400	20	2.400	5							234334
		65	8	1.050	1.950 - 2.400	20	2.400	5							234325
			10	1.050	1.950 - 2.400	20	2.400	5							234335
		70	8	1.050	1.950 - 2.400	20	2.400	5							234326
			10	1.050	1.950 - 2.400	20	2.400	5							234336
		80	8	1.050	1.950 - 2.400	20	2.400	5							234327
			10	1.050	1.950 - 2.400	20	2.400	5							234337

4

Flat faceplate 24 mm

234384











4.8.1.4 Door lock Z-TS Module PT-M with 2 HO E92 F-24															
		L												No	
modular	silver	92	35	8	1.050	1.950 - 2.400	24	2.400	5					234380	
			10	1.050	1.950 - 2.400	24	2.400	5						234390	
		40	8	1.050	1.950 - 2.400	24	2.400	5							234381
			10	1.050	1.950 - 2.400	24	2.400	5							234391
		45	8	1.050	1.950 - 2.400	24	2.400	5							234382
			10	1.050	1.950 - 2.400	24	2.400	5							234392
		50	8	1.050	1.950 - 2.400	24	2.400	5							234383
			10	1.050	1.950 - 2.400	24	2.400	5							234393
		55	8	1.050	1.950 - 2.400	24	2.400	5							234384
			10	1.050	1.950 - 2.400	24	2.400	5							234394
		65	8	1.050	1.950 - 2.400	24	2.400	5							234385
			10	1.050	1.950 - 2.400	24	2.400	5							234395
		70	8	1.050	1.950 - 2.400	24	2.400	5							234386
			10	1.050	1.950 - 2.400	24	2.400	5							234396
		80	8	1.050	1.950 - 2.400	24	2.400	5							234387
			10	1.050	1.950 - 2.400	24	2.400	5							234397

Top hat faceplate 24/16 mm

239494









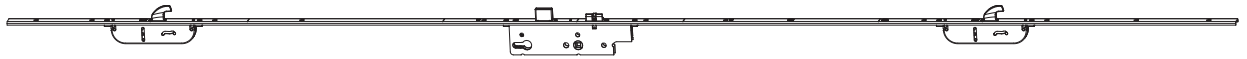

4.8.1.5 Door lock Z-TS Module PT-M with 2 HO E92 F-24/16											No
modular	silver	92	35	8	1.050	1.950 - 2.400	24/16	2.400	5		239490
				10	1.050	1.950 - 2.400	24/16	2.400	5		239500
			40	8	1.050	1.950 - 2.400	24/16	2.400	5		239491
				10	1.050	1.950 - 2.400	24/16	2.400	5		239501
			45	8	1.050	1.950 - 2.400	24/16	2.400	5		239492
				10	1.050	1.950 - 2.400	24/16	2.400	5		239502
			50	8	1.050	1.950 - 2.400	24/16	2.400	5		239493
				10	1.050	1.950 - 2.400	24/16	2.400	5		239503
			55	8	1.050	1.950 - 2.400	24/16	2.400	5		239494
				10	1.050	1.950 - 2.400	24/16	2.400	5		239504
			65	8	1.050	1.950 - 2.400	24/16	2.400	5		239495
				10	1.050	1.950 - 2.400	24/16	2.400	5		239505
			70	8	1.050	1.950 - 2.400	24/16	2.400	5		239496
				10	1.050	1.950 - 2.400	24/16	2.400	5		239506
			80	8	1.050	1.950 - 2.400	24/16	2.400	5		239497
				10	1.050	1.950 - 2.400	24/16	2.400	5		239507

U-faceplate 6x24x6 mm

239764



4.8.1.6 Door lock Z-TS Module PT-M with 2 HO E92 U-6x24x6											No
fixed handle height	silver	92	35	8	1.050	1.950 - 2.200	24	2.200	5		239760
				10	1.050	1.950 - 2.200	24	2.200	5		239750
			40	8	1.050	1.950 - 2.200	24	2.200	5		239761
				10	1.050	1.950 - 2.200	24	2.200	5		239751
			45	8	1.050	1.950 - 2.200	24	2.200	5		239762
				10	1.050	1.950 - 2.200	24	2.200	5		239752
			50	8	1.050	1.950 - 2.200	24	2.200	5		239763
				10	1.050	1.950 - 2.200	24	2.200	5		239753
			55	8	1.050	1.950 - 2.200	24	2.200	5		239764
				10	1.050	1.950 - 2.200	24	2.200	5		239754
			65	8	1.050	1.950 - 2.200	24	2.200	5		239765
				10	1.050	1.950 - 2.200	24	2.200	5		239755
			70	8	1.050	1.950 - 2.200	24	2.200	5		239766
				10	1.050	1.950 - 2.200	24	2.200	5		239756
			80	8	1.050	1.950 - 2.200	24	2.200	5		239767
				10	1.050	1.950 - 2.200	24	2.200	5		239757

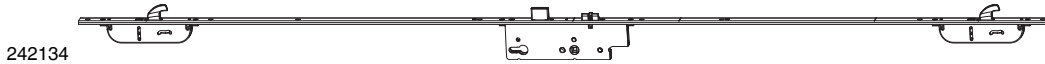

242134

**4.8.1.7 Door lock Z-TS Module PT-M
with 2 HO E92 U-6x24x6 HH885**



fixed handle height	silver	92	35	8	885	2.000 - 2.200	24	1.740	5	No
				10	885	2.000 - 2.200	24	1.740	5	242130
			40	8	885	2.000 - 2.200	24	1.740	5	242131
				10	885	2.000 - 2.200	24	1.740	5	242141
			45	8	885	2.000 - 2.200	24	1.740	5	242132
				10	885	2.000 - 2.200	24	1.740	5	242142
			50	8	885	2.000 - 2.200	24	1.740	5	242133
				10	885	2.000 - 2.200	24	1.740	5	242143
			55	8	885	2.000 - 2.200	24	1.740	5	242134
				10	885	2.000 - 2.200	24	1.740	5	242144

4



242194

**4.8.1.8 Door lock Z-TS Module PT-M
with 2 HO E92 U-6x24x6 K+375 HH885**



fixed handle height	silver	92	35	8	885	1.500 - 1.800	24	1.385	5	No
				10	885	1.500 - 1.800	24	1.385	5	242190
			40	8	885	1.500 - 1.800	24	1.385	5	242191
				10	885	1.500 - 1.800	24	1.385	5	242201
			45	8	885	1.500 - 1.800	24	1.385	5	242192
				10	885	1.500 - 1.800	24	1.385	5	242202
			50	8	885	1.500 - 1.800	24	1.385	5	242193
				10	885	1.500 - 1.800	24	1.385	5	242203
			55	8	885	1.500 - 1.800	24	1.385	5	242194
				10	885	1.500 - 1.800	24	1.385	5	242204



242154

**4.8.1.9 Door lock Z-TS Module PT-M
with 2 HO E92 U-6x24x6 K+605 HH885**



fixed handle height	silver	92	35	8	885	1.800 - 2.000	24	1.615	5	No
				10	885	1.800 - 2.000	24	1.615	5	242150
			40	8	885	1.800 - 2.000	24	1.615	5	242151
				10	885	1.800 - 2.000	24	1.615	5	242161
			45	8	885	1.800 - 2.000	24	1.615	5	242152
				10	885	1.800 - 2.000	24	1.615	5	242162
			50	8	885	1.800 - 2.000	24	1.615	5	242153
				10	885	1.800 - 2.000	24	1.615	5	242163
			55	8	885	1.800 - 2.000	24	1.615	5	242154
				10	885	1.800 - 2.000	24	1.615	5	242164

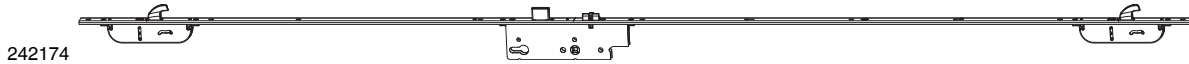

242174

4.8.1.10 Door lock Z-TS Module PT-M with 2 HO E92 U-6x24x6 K+980 HH885								L		No
fixed handle height	silver	92	35	8	885	2.200 - 2.400	24	1.990	5	242170
				10	885	2.200 - 2.400	24	1.990	5	242180
		40	8	885	2.200 - 2.400	24	1.990	5	242171	
										10
		45	8	885	2.200 - 2.400	24	1.990	5	242172	
										10
		50	8	885	2.200 - 2.400	24	1.990	5	242173	
										10
		55	8	885	2.200 - 2.400	24	1.990	5	242174	
										10

Flat faceplate 16 mm

234274



4.8.1.11 Door lock Z-TS Module PT-M with 2 HO E88 F-16								L		No	
modular	silver	88	35	8,5	1.050	1.950 - 2.400	16	2.400	5	234270	
				40	8,5	1.050	1.950 - 2.400	16	2.400	5	234271
				45	8,5	1.050	1.950 - 2.400	16	2.400	5	234272
				50	8,5	1.050	1.950 - 2.400	16	2.400	5	234273
				55	8,5	1.050	1.950 - 2.400	16	2.400	5	234274
				65	8,5	1.050	1.950 - 2.400	16	2.400	5	234275
				70	8,5	1.050	1.950 - 2.400	16	2.400	5	234276
				80	8,5	1.050	1.950 - 2.400	16	2.400	5	234277

Flat faceplate 20 mm

234314



4.8.1.12 Door lock Z-TS Module PT-M with 2 HO E88 F-20								L		No	
modular	silver	88	35	8,5	1.050	1.950 - 2.400	20	2.400	5	234310	
				40	8,5	1.050	1.950 - 2.400	20	2.400	5	234311
				45	8,5	1.050	1.950 - 2.400	20	2.200	5	234312
				50	8,5	1.050	1.950 - 2.400	20	2.400	5	234313
				55	8,5	1.050	1.950 - 2.400	20	2.400	5	234314
				65	8,5	1.050	1.950 - 2.400	20	2.400	5	234315
				70	8,5	1.050	1.950 - 2.400	20	2.400	5	234316
				80	8,5	1.050	1.950 - 2.400	20	2.400	5	234317

4.9 Door lock Z-TS Module with HO + ZS

4.9.1 Door lock Z-TS with 2 HO + ZS

234344



4.9.1.1 Door lock Z-TS Module PT-M with 2 HO + ZS E92 F-20

								L		No
modular	silver	92	35	8	1.050	1.950 - 2.400	20	2.400	5	234340
				10	1.050	1.950 - 2.400	20	2.400	5	234350
		40	8	1.050	1.950 - 2.400	20	2.400	5	234341	
			10	1.050	1.950 - 2.400	20	2.400	5	234351	
		45	8	1.050	1.950 - 2.400	20	2.400	5	234342	
			10	1.050	1.950 - 2.400	20	2.400	5	234352	
		50	8	1.050	1.950 - 2.400	20	2.400	5	234343	
			10	1.050	1.950 - 2.400	20	2.400	5	234353	
		55	8	1.050	1.950 - 2.400	20	2.400	5	234344	
			10	1.050	1.950 - 2.400	20	2.400	5	234354	
		65	8	1.050	1.950 - 2.400	20	2.400	5	234345	
			10	1.050	1.950 - 2.400	20	2.400	5	234355	
		70	8	1.050	1.950 - 2.400	20	2.400	5	234346	
			10	1.050	1.950 - 2.400	20	2.400	5	234356	
		80	8	1.050	1.950 - 2.400	20	2.400	5	234347	
			10	1.050	1.950 - 2.400	20	2.400	5	234357	

4.10 Door lock Z-TS Module with BO + i.S.













4.10.1 Door lock Z-TS with 2 BO + 2i.S.

Flat faceplate 16 mm

238614



4.10.1.1 Door lock Z-TS Module PT-M with 2 BO + 2i.S. E92 F-16













													
		92											No
modular	silver	35	8	1.050	1.950 - 2.400	16	2.400	5	238610				
		40	8	1.050	1.950 - 2.400	16	2.400	5	238611				
			10	1.050	1.950 - 2.400	16	2.400	5	238621				
		45	8	1.050	1.950 - 2.400	16	2.400	5	238612				
			10	1.050	1.950 - 2.400	16	2.400	5	238622				
		50	8	1.050	1.950 - 2.400	16	2.400	5	238613				
			10	1.050	1.950 - 2.400	16	2.400	5	238623				
		55	8	1.050	1.950 - 2.400	16	2.400	5	238614				
			10	1.050	1.950 - 2.400	16	2.400	5	238624				
		65	8	1.050	1.950 - 2.400	16	2.400	5	238615				
			10	1.050	1.950 - 2.400	16	2.400	5	238625				
		70	8	1.050	1.950 - 2.400	16	2.400	5	238616				
			10	1.050	1.950 - 2.400	16	2.400	5	238626				
		80	8	1.050	1.950 - 2.400	16	2.400	5	238617				
			10	1.050	1.950 - 2.400	16	2.400	5	238627				

Flat faceplate 20 mm

238764



4.10.1.2 Door lock Z-TS Module PT-M with 2 BO + 2i.S. E92 F-20

													
		92											No
modular	silver	35	8	1.050	1.950 - 2.400	20	2.400	5	238760				
		40	8	1.050	1.950 - 2.400	20	2.400	5	238761				
			10	1.050	1.950 - 2.400	20	2.400	5	238771				
		45	8	1.050	1.950 - 2.400	20	2.400	5	238762				
			10	1.050	1.950 - 2.400	20	2.400	5	238772				
		50	8	1.050	1.950 - 2.400	20	2.400	5	238763				
			10	1.050	1.950 - 2.400	20	2.400	5	238773				
		55	8	1.050	1.950 - 2.400	20	2.400	5	238764				
			10	1.050	1.950 - 2.400	20	2.400	5	238774				
		65	8	1.050	1.950 - 2.400	20	2.400	5	238765				
			10	1.050	1.950 - 2.400	20	2.400	5	238775				
		70	8	1.050	1.950 - 2.400	20	2.400	5	238766				
			10	1.050	1.950 - 2.400	20	2.400	5	238776				
		80	8	1.050	1.950 - 2.400	20	2.400	5	238767				
			10	1.050	1.950 - 2.400	20	2.400	5	238777				

4.11 Door lock Z-TS Module with BO







4.11.1 Door lock Z-TS with 2 BO

Flat faceplate 16 mm

234604



4.11.1.1 Door lock Z-TS Module PT-M with 2 BO E92 F-16







								L		No
modular	silver	92	35	8	1.050	1.950 - 2.400	16	2.400	5	234600
				10	1.050	1.950 - 2.400	16	2.400	5	234450
			40	8	1.050	1.950 - 2.400	16	2.400	5	234601
				10	1.050	1.950 - 2.400	16	2.400	5	234451
			45	8	1.050	1.950 - 2.400	16	2.400	5	234602
				10	1.050	1.950 - 2.400	16	2.400	5	234452
			50	8	1.050	1.950 - 2.400	16	2.400	5	234603
				10	1.050	1.950 - 2.400	16	2.400	5	234453
			55	8	1.050	1.950 - 2.400	16	2.400	5	234604
				10	1.050	1.950 - 2.400	16	2.400	5	234454
			65	8	1.050	1.950 - 2.400	16	2.400	5	234605
				10	1.050	1.950 - 2.400	16	2.400	5	234455
			70	8	1.050	1.950 - 2.400	16	2.400	5	234606
				10	1.050	1.950 - 2.400	16	2.400	5	234456
			80	8	1.050	1.950 - 2.400	16	2.400	5	234607
				10	1.050	1.950 - 2.400	16	2.400	5	234457

Flat faceplate 20 mm

234504









4.11.1.2 Door lock Z-TS Module PT-M with 2 BO E92 F-20

								L		No
modular	silver	92	35	8	1.050	1.950 - 2.400	20	2.400	5	234500
				10	1.050	1.950 - 2.400	20	2.400	5	234510
			40	8	1.050	1.950 - 2.400	20	2.400	5	234501
				10	1.050	1.950 - 2.400	20	2.400	5	234511
			45	8	1.050	1.950 - 2.400	20	2.400	5	234502
				10	1.050	1.950 - 2.400	20	2.400	5	234512
			50	8	1.050	1.950 - 2.400	20	2.400	5	234503
				10	1.050	1.950 - 2.400	20	2.400	5	234513
			55	8	1.050	1.950 - 2.400	20	2.400	5	234504
				10	1.050	1.950 - 2.400	20	2.400	5	234514
			65	8	1.050	1.950 - 2.400	20	2.400	5	234505
				10	1.050	1.950 - 2.400	20	2.400	5	234515
			70	8	1.050	1.950 - 2.400	20	2.400	5	234506
				10	1.050	1.950 - 2.400	20	2.400	5	234516
			80	8	1.050	1.950 - 2.400	20	2.400	5	234507
				10	1.050	1.950 - 2.400	20	2.400	5	234517

Flat faceplate 24 mm

234564









4.11.1.3 Door lock Z-TS Module PT-M with 2 BO E92 F-24								L		No
modular	silver	92	35	8	1.050	1.950 - 2.400	24	2.400	5	234560
				10	1.050	1.950 - 2.400	24	2.400	5	234570
			40	8	1.050	1.950 - 2.400	24	2.400	5	234561
				10	1.050	1.950 - 2.400	24	2.400	5	234571
			45	8	1.050	1.950 - 2.400	24	2.400	5	234562
				10	1.050	1.950 - 2.400	24	2.400	5	234572
			50	8	1.050	1.950 - 2.400	24	2.400	5	234563
				10	1.050	1.950 - 2.400	24	2.400	5	234573
			55	8	1.050	1.950 - 2.400	24	2.400	5	234564
				10	1.050	1.950 - 2.400	24	2.400	5	234574
			65	8	1.050	1.950 - 2.400	24	2.400	5	234565
				10	1.050	1.950 - 2.400	24	2.400	5	234575
			70	8	1.050	1.950 - 2.400	24	2.400	5	234566
				10	1.050	1.950 - 2.400	24	2.400	5	234576
			80	8	1.050	1.950 - 2.400	24	2.400	5	234567
				10	1.050	1.950 - 2.400	24	2.400	5	234577

Top hat faceplate 24/16 mm

239474







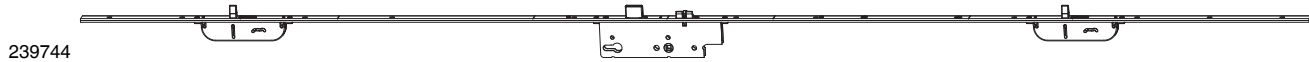

4.11.1.4 Door lock Z-TS Module PT-M with 2 BO E92 F-24/16								L		No
modular	silver	92	35	8	1.050	1.950 - 2.400	24/16	2.400	5	239470
				10	1.050	1.950 - 2.400	24/16	2.400	5	239480
			40	8	1.050	1.950 - 2.400	24/16	2.400	5	239471
				10	1.050	1.950 - 2.400	24/16	2.400	5	239481
			45	8	1.050	1.950 - 2.400	24/16	2.400	5	239472
				10	1.050	1.950 - 2.400	24/16	2.400	5	239482
			50	8	1.050	1.950 - 2.400	24/16	2.400	5	239473
				10	1.050	1.950 - 2.400	24/16	2.400	5	239483
			55	8	1.050	1.950 - 2.400	24/16	2.400	5	239474
				10	1.050	1.950 - 2.400	24/16	2.400	5	239484
			65	8	1.050	1.950 - 2.400	24/16	2.400	5	239475
				10	1.050	1.950 - 2.400	24/16	2.400	5	239485
			70	8	1.050	1.950 - 2.400	24/16	2.400	5	239476
				10	1.050	1.950 - 2.400	24/16	2.400	5	239486
			80	8	1.050	1.950 - 2.400	24/16	2.400	5	239477
				10	1.050	1.950 - 2.400	24/16	2.400	5	239487

U-faceplate 6x24x6 mm









239744

4.11.1.5 Door lock Z-TS Module PT-M with 2 BO E92 U-6x24x6								L		No
modular	silver	92	35	8	1.050	1.950 - 2.200	24	2.200	5	239740
				10	1.050	1.950 - 2.200	24	2.200	5	239730
			40	8	1.050	1.950 - 2.200	24	2.200	5	239741
				10	1.050	1.950 - 2.200	24	2.200	5	239731
			45	8	1.050	1.950 - 2.200	24	2.200	5	239742
				10	1.050	1.950 - 2.200	24	2.200	5	239732
			50	8	1.050	1.950 - 2.200	24	2.200	5	239743
				10	1.050	1.950 - 2.200	24	2.200	5	239733
			55	8	1.050	1.950 - 2.200	24	2.200	5	239744
				10	1.050	1.950 - 2.200	24	2.200	5	239734
			65	8	1.050	1.950 - 2.200	24	2.200	5	239745
				10	1.050	1.950 - 2.200	24	2.200	5	239735
			70	8	1.050	1.950 - 2.200	24	2.200	5	239746
				10	1.050	1.950 - 2.200	24	2.200	5	239736
			80	8	1.050	1.950 - 2.200	24	2.200	5	239747
				10	1.050	1.950 - 2.200	24	2.200	5	239737

4









242214

4.11.1.6 Door lock Z-TS Module PT-M with 2 BO E92 U-6x24x6 HH885								L		No
modular	silver	92	35	8	885	2.000 - 2.200	24	1.740	5	242210
				10	885	2.000 - 2.200	24	1.740	5	242220
			40	8	885	2.000 - 2.200	24	1.740	5	242211
				10	885	2.000 - 2.200	24	1.740	5	242221
			45	8	885	2.000 - 2.200	24	1.740	5	242212
				10	885	2.000 - 2.200	24	1.740	5	242222
			50	8	885	2.000 - 2.200	24	1.740	5	242213
				10	885	2.000 - 2.200	24	1.740	5	242223
			55	8	885	2.000 - 2.200	24	1.740	5	242214
				10	885	2.000 - 2.200	24	1.740	5	242224



242314

4.11.1.7 Door lock Z-TS Module PT-M with 2 BO E92 U-6x24x6 HH885 and door turn-restrictor								L		No
fixed handle height	silver	92	35	8	885	2.000 - 2.200	24	1.740	5	242310
				10	885	2.000 - 2.200	24	1.740	5	242320
			40	8	885	2.000 - 2.200	24	1.740	5	242311
				10	885	2.000 - 2.200	24	1.740	5	242321
			45	8	885	2.000 - 2.200	24	1.740	5	242312
				10	885	2.000 - 2.200	24	1.740	5	242322
			50	8	885	2.000 - 2.200	24	1.740	5	242313
				10	885	2.000 - 2.200	24	1.740	5	242323
			55	8	885	2.000 - 2.200	24	1.740	5	242314
				10	885	2.000 - 2.200	24	1.740	5	242324

242274



**4.11.1.8 Door lock Z-TS Module PT-M
with 2 BO E92 U-6x24x6 K+375 HH885**



fixed handle height	silver	92	35	8	885	1.500 - 1.800	24	1.385	5	No
				10	885	1.500 - 1.800	24	1.385	5	242270
			40	8	885	1.500 - 1.800	24	1.385	5	242271
				10	885	1.500 - 1.800	24	1.385	5	242281
			45	8	885	1.500 - 1.800	24	1.385	5	242272
				10	885	1.500 - 1.800	24	1.385	5	242282
			50	8	885	1.500 - 1.800	24	1.385	5	242273
				10	885	1.500 - 1.800	24	1.385	5	242283
			55	8	885	1.500 - 1.800	24	1.385	5	242274
				10	885	1.500 - 1.800	24	1.385	5	242284

242234

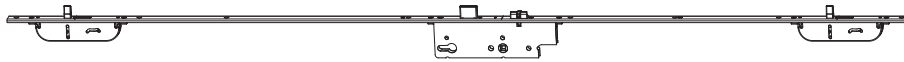

**4.11.1.9 Door lock Z-TS Module PT-M
with 2 BO E92 U-6x24x6 K+605 HH885**



fixed handle height	silver	92	35	8	885	1.800 - 2.000	24	1.615	5	No
				10	885	1.800 - 2.000	24	1.615	5	242230
			40	8	885	1.800 - 2.000	24	1.615	5	242231
				10	885	1.800 - 2.000	24	1.615	5	242241
			45	8	885	1.800 - 2.000	24	1.615	5	242232
				10	885	1.800 - 2.000	24	1.615	5	242242
			50	8	885	1.800 - 2.000	24	1.615	5	242233
				10	885	1.800 - 2.000	24	1.615	5	242243
			55	8	885	1.800 - 2.000	24	1.615	5	242234
				10	885	1.800 - 2.000	24	1.615	5	242244

242254

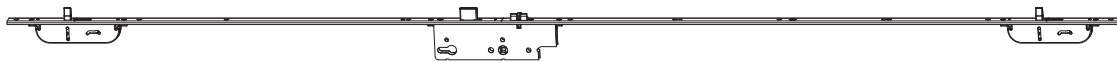

**4.11.1.10 Door lock Z-TS Module PT-M
with 2 BO E92 U-6x24x6 K+980 HH885**



fixed handle height	silver	92	35	8	885	2.200 - 2.400	24	1.990	5	No
				10	885	2.200 - 2.400	24	1.990	5	242250
			40	8	885	2.200 - 2.400	24	1.990	5	242251
				10	885	2.200 - 2.400	24	1.990	5	242261
			45	8	885	2.200 - 2.400	24	1.990	5	242252
				10	885	2.200 - 2.400	24	1.990	5	242262
			50	8	885	2.200 - 2.400	24	1.990	5	242253
				10	885	2.200 - 2.400	24	1.990	5	242263
			55	8	885	2.200 - 2.400	24	1.990	5	242254
				10	885	2.200 - 2.400	24	1.990	5	242264

Flat faceplate 16 mm

234434



4.11.1.11 Door lock Z-TS Module PT-M with 2 BO E88 F-16



modular	silver	88						L		No
		35	8,5	1.050	1.950 - 2.400	16	2.400	5	234430	
		40	8,5	1.050	1.950 - 2.400	16	2.400	5	234431	
		45	8,5	1.050	1.950 - 2.400	16	2.400	5	234432	
		50	8,5	1.050	1.950 - 2.400	16	2.400	5	234433	
		55	8,5	1.050	1.950 - 2.400	16	2.400	5	234434	
		65	8,5	1.050	1.950 - 2.400	16	2.400	5	234435	
		70	8,5	1.050	1.950 - 2.400	16	2.400	5	234436	
		80	8,5	1.050	1.950 - 2.400	16	2.400	5	234437	

Flat faceplate 20 mm

234494



4.11.1.12 Door lock Z-TS Module PT-M with 2 BO E88 F-20



modular	silver	88						L		No
		35	8,5	1.050	1.950 - 2.400	20	2.400	5	234490	
		40	8,5	1.050	1.950 - 2.400	20	2.400	5	234491	
		45	8,5	1.050	1.950 - 2.400	20	2.400	5	234492	
		50	8,5	1.050	1.950 - 2.400	20	2.400	5	234493	
		55	8,5	1.050	1.950 - 2.400	20	2.400	5	234494	
		65	8,5	1.050	1.950 - 2.400	20	2.400	5	234495	
		70	8,5	1.050	1.950 - 2.400	20	2.400	5	234496	
		80	8,5	1.050	1.950 - 2.400	20	2.400	5	234497	

Flat faceplate 16 mm

238504



4.11.1.13 Door lock Z-TS Module PT-M with 2 BO E94 F-16









modular	silver	94						L		No
		35	9	1.050	1.950 - 2.400	16	2.400	5	238500	
		40	9	1.050	1.950 - 2.400	16	2.400	5	238501	
		45	9	1.050	1.950 - 2.400	16	2.400	5	238502	
		50	9	1.050	1.950 - 2.400	16	2.400	5	238503	
		55	9	1.050	1.950 - 2.400	16	2.400	5	238504	
		65	9	1.050	1.950 - 2.400	16	2.400	5	238505	
		70	9	1.050	1.950 - 2.400	16	2.400	5	238506	
		80	9	1.050	1.950 - 2.400	16	2.400	5	238507	

Flat faceplate 20 mm

238524









4.11.1.14 Door lock Z-TS Module PT-M with 2 BO E94 F-20								L		No
modular	silver	94	35	9	1.050	1.950 - 2.400	20	2.400	5	238520
			40	9	1.050	1.950 - 2.400	20	2.400	5	238521
			45	9	1.050	1.950 - 2.400	20	2.400	5	238522
			50	9	1.050	1.950 - 2.400	20	2.400	5	238523
			55	9	1.050	1.950 - 2.400	20	2.400	5	238524
			65	9	1.050	1.950 - 2.400	20	2.400	5	238525
			70	9	1.050	1.950 - 2.400	20	2.400	5	238526
			80	9	1.050	1.950 - 2.400	20	2.400	5	238527

Top hat faceplate 24/16 mm

238544







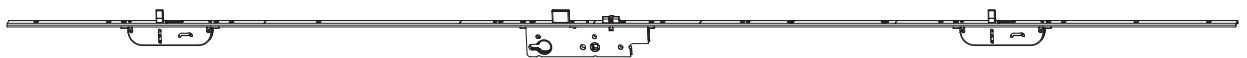

4.11.1.15 Door lock Z-TS Module PT-M with 2B O E94 F-24/16								L		No
modular	silver	94	35	9	1.050	1.950 - 2.400	24/16	2.400	5	238540
			40	9	1.050	1.950 - 2.400	24/16	2.400	5	238541
			45	9	1.050	1.950 - 2.400	24/16	2.400	5	238542
			50	9	1.050	1.950 - 2.400	24/16	2.400	5	238543
			55	9	1.050	1.950 - 2.400	24/16	2.400	5	238544
			65	9	1.050	1.950 - 2.400	24/16	2.400	5	238545
			70	9	1.050	1.950 - 2.400	24/16	2.400	5	238546
			80	9	1.050	1.950 - 2.400	24/16	2.400	5	238547

U-faceplate 6x24x6 mm

238482



4.11.1.16 Door lock Z-TS Module PT-M with 2 BO E94 U-6x24x6								L		No
modular	silver	94	45	9	1.050	1.950 - 2.200	24	2.200	5	238482

4.12 Door lock Z-TS Module with bolts + ZS







4.12.1 Door lock Z-TS with 2 bolts + ZS

Flat faceplate 16 mm

234614



4.12.1.1 Door lock Z-TS Module PT-M with 2 BO + ZS E92 F-16







								L		No
modular	silver	92	35	8	1.050	1.950 - 2.400	16	2.400	5	234610
				10	1.050	1.950 - 2.400	16	2.400	5	234470
		40	8	1.050	1.950 - 2.400	16	2.400	5	234611	
			10	1.050	1.950 - 2.400	16	2.400	5	234471	
		45	8	1.050	1.950 - 2.400	16	2.400	5	234612	
			10	1.050	1.950 - 2.400	16	2.400	5	234472	
		50	8	1.050	1.950 - 2.400	16	2.400	5	234613	
			10	1.050	1.950 - 2.400	16	2.400	5	234473	
		55	8	1.050	1.950 - 2.400	16	2.400	5	234614	
			10	1.050	1.950 - 2.400	16	2.400	5	234474	
		65	8	1.050	1.950 - 2.400	16	2.400	5	234615	
			10	1.050	1.950 - 2.400	16	2.400	5	234475	
		70	8	1.050	1.950 - 2.400	16	2.400	5	234616	
			10	1.050	1.950 - 2.400	16	2.400	5	234476	
		80	8	1.050	1.950 - 2.400	16	2.400	5	234617	
			10	1.050	1.950 - 2.400	16	2.400	5	234477	

Flat faceplate 20 mm

234524



4.12.1.2 Door lock Z-TS Module PT-M with 2 BO + ZS E92 F-20

								L		No
modular	silver	92	35	8	1.050	1.950 - 2.400	20	2.400	5	234520
				10	1.050	1.950 - 2.400	20	2.400	5	234530
		40	8	1.050	1.950 - 2.400	20	2.400	5	234521	
			10	1.050	1.950 - 2.400	20	2.400	5	234531	
		45	8	1.050	1.950 - 2.400	20	2.400	5	234522	
			10	1.050	1.950 - 2.400	20	2.400	5	234532	
		50	8	1.050	1.950 - 2.400	20	2.400	5	234523	
			10	1.050	1.950 - 2.400	20	2.400	5	234533	
		55	8	1.050	1.950 - 2.400	20	2.400	5	234524	
			10	1.050	1.950 - 2.400	20	2.400	5	234534	
		65	8	1.050	1.950 - 2.400	20	2.400	5	234525	
			10	1.050	1.950 - 2.400	20	2.400	5	234535	
		70	8	1.050	1.950 - 2.400	20	2.400	5	234526	
			10	1.050	1.950 - 2.400	20	2.400	5	234536	
		80	8	1.050	1.950 - 2.400	20	2.400	5	234527	
			10	1.050	1.950 - 2.400	20	2.400	5	234537	

**MACO
PROTECT**



Z-TS Cylinder Operated Door Lock



5 G-TS Lever operated Door Lock

5.1	Hardware overview G-TS	112
5.2	Door lock G-TS Module with i.S.	118
5.2.1	Door lock G-TS with 4 i.S.	118
5.2.2	Door lock G-TS with 2 i.S.	120
5.3	Door lock G-TS Module with HO-BO + i.S.	121
5.3.1	Door lock G-TS with 2 HO-BO + 2 i.S.	121
5.4	Door lock G-TS Module with HO-BO	122
5.4.1	Door lock G-TS with 2 HO-BO	122
5.4.2	Door lock G-TS with 4 HO-BO	124
5.5	Door lock G-TS Module with HO and i.S.	126
5.5.1	Door lock G-TS with 2 HO and 2 i.S.	126
5.6	Door lock G-TS Module with HO	127
5.6.1	Door lock G-TS with 2 HO	127
5.7	Door lock G-TS Module with BO and i.S.	129
5.7.1	Door lock G-TS with 2 BO and 2 i.S.	129
5.8	Door lock G-TS Module with BO	130
5.8.1	Door lock G-TS with 2 BO	130
5.9	Door lock G-TS Module without i.S.	133
5.9.1	Door lock G-TS without i.S.	133

5 G-TS Lever operated Door Lock

5.1 Hardware overview G-TS

3.1m

MACO PROTECT MODULE

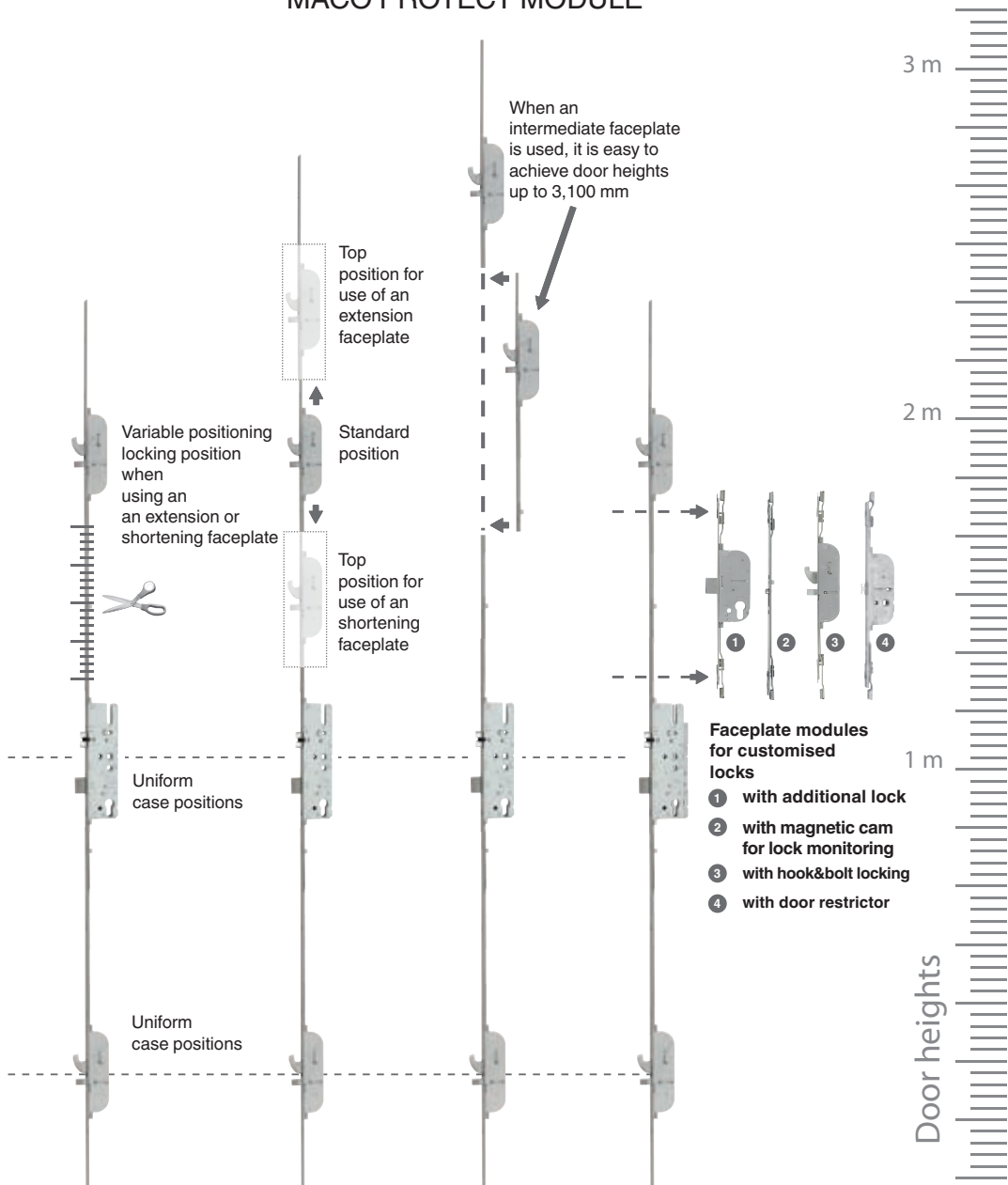

- ① 2 x hook&bolt
- ② 4 x hook&bolt
- ③ 2x hook&bolt + additional lock

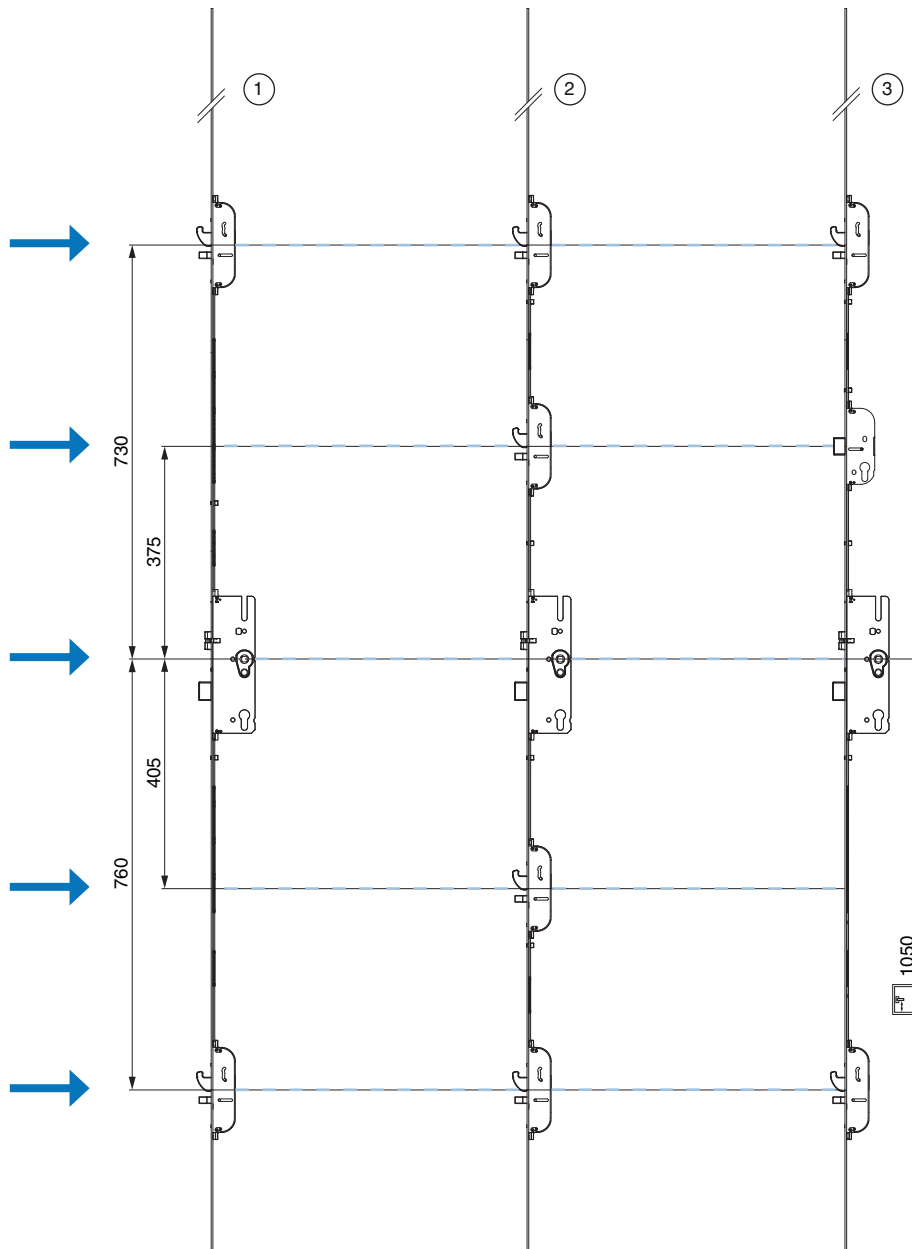

- ① standard lock
- ② shortening faceplate
- ③ extension faceplate

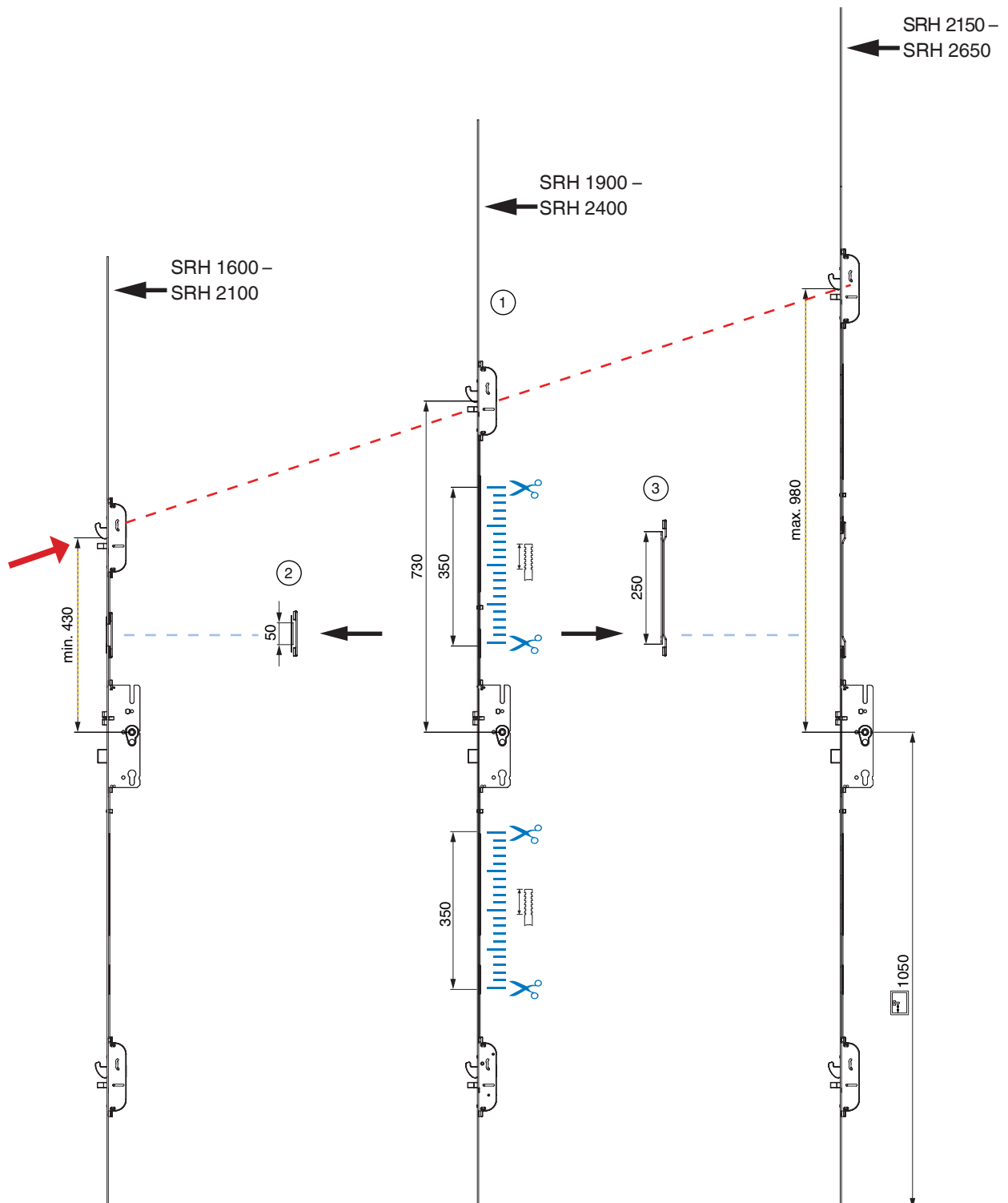

- ① standard lock
- ② faceplate module ZS
- ③ faceplate module hook&bolt
- ④ faceplate module magnetic cam
- ⑤ faceplate module door restrictor

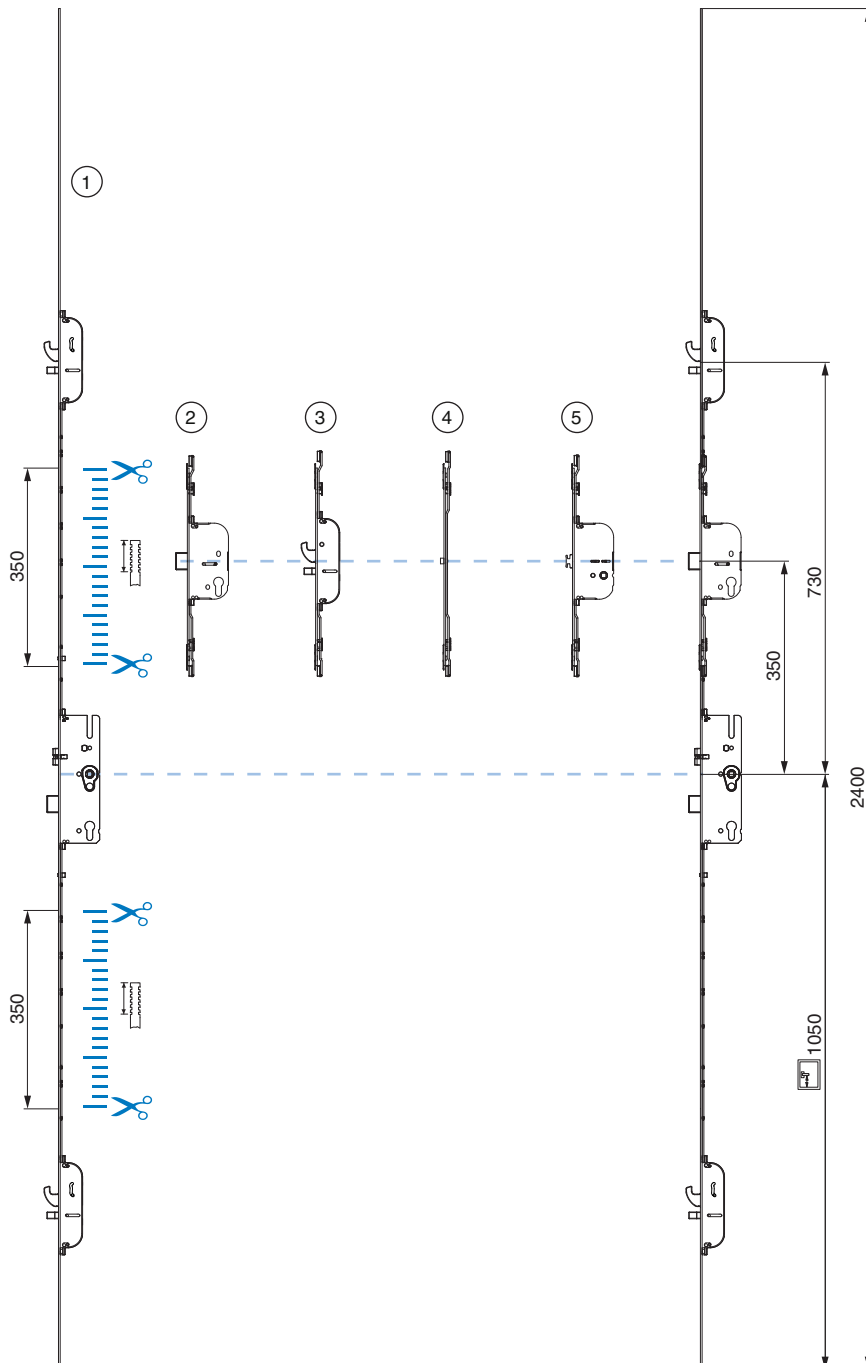



2 hook&bolt

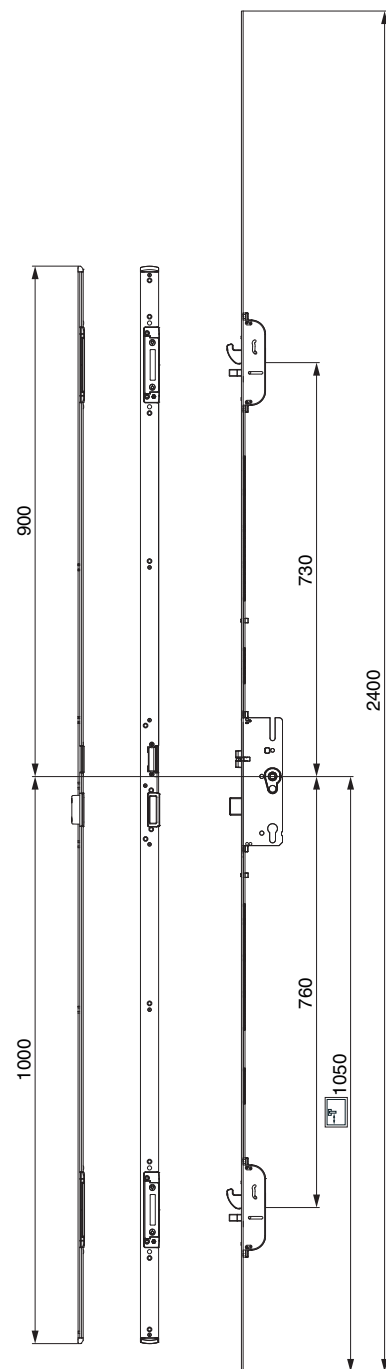
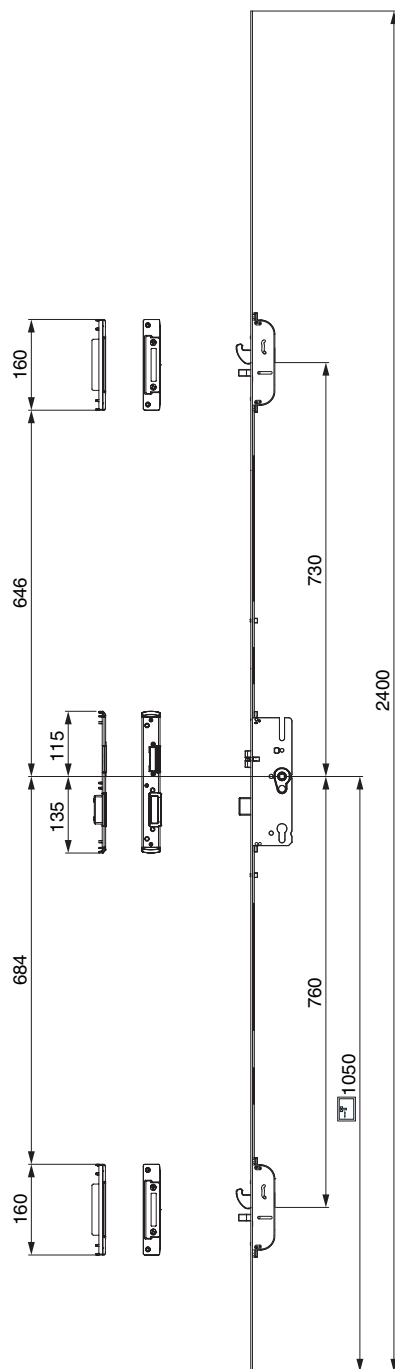



4 i.S.

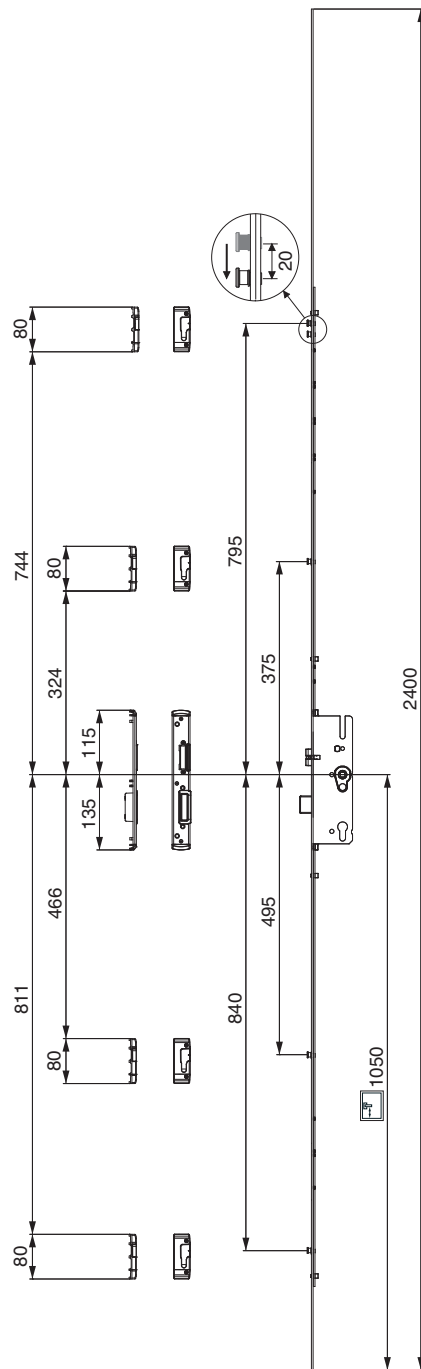

5.2 Door lock G-TS Module with i.S.

5.2.1 Door lock G-TS with 4 i.S.

Flat faceplate 16 mm

232015



5.2.1.1 Door lock G-TS Module PT-M with 4 i.S. E92 F-16

								L		No
extendable	silver	92	28	8	1.050	1.950 - 2.400	16	2.400	5	232010
				10	1.050	1.950 - 2.400	16	2.400	5	232500
				8	1.050	1.950 - 2.400	16	2.400	5	232011
				10	1.050	1.950 - 2.400	16	2.400	5	232501
				8	1.050	1.950 - 2.400	16	2.400	5	232012
				10	1.050	1.950 - 2.400	16	2.400	5	232502
				8	1.050	1.950 - 2.400	16	2.400	5	232013
				10	1.050	1.950 - 2.400	16	2.400	5	232503
				8	1.050	1.950 - 2.400	16	2.400	5	232014
				10	1.050	1.950 - 2.400	16	2.400	5	232504
				8	1.050	1.950 - 2.400	16	2.400	5	232015
				10	1.050	1.950 - 2.400	16	2.400	5	232505
				8	1.050	1.950 - 2.400	16	2.400	5	232016
				10	1.050	1.950 - 2.400	16	2.400	5	232506
				8	1.050	1.950 - 2.400	16	2.400	5	232017
				10	1.050	1.950 - 2.400	16	2.400	5	232507

Flat faceplate 20 mm

232215



5.2.1.2 Door lock G-TS Module PT-M with 4 i.S. E92 F-20

								L		No
extendable	silver	92	28	8	1.050	1.950 - 2.400	20	2.400	5	232210
				10	1.050	1.950 - 2.400	20	2.400	5	232570
				8	1.050	1.950 - 2.400	20	2.400	5	232211
				10	1.050	1.950 - 2.400	20	2.400	5	232571
				8	1.050	1.950 - 2.400	20	2.400	5	232212
				10	1.050	1.950 - 2.400	20	2.400	5	232572
				8	1.050	1.950 - 2.400	20	2.400	5	232213
				10	1.050	1.950 - 2.400	20	2.400	5	232573
				8	1.050	1.950 - 2.400	20	2.400	5	232214
				10	1.050	1.950 - 2.400	20	2.400	5	232574
				8	1.050	1.950 - 2.400	20	2.400	5	232215
				10	1.050	1.950 - 2.400	20	2.400	5	232575
				8	1.050	1.950 - 2.400	20	2.400	5	232216
				10	1.050	1.950 - 2.400	20	2.400	5	232576
				8	1.050	1.950 - 2.400	20	2.400	5	232217
				10	1.050	1.950 - 2.400	20	2.400	5	232577

Top hat faceplate 24/16 mm

241945



5.2.1.3 Door lock G-TS Module PT-M with 4 i.S. E92 F-24/16



extendable	silver	92	28	8	1.050	1.950 - 2.400	24/16	2.400	5	No
			35	8	1.050	1.950 - 2.400	24/16	2.400	5	241941
			40	8	1.050	1.950 - 2.400	24/16	2.400	5	241942
			45	8	1.050	1.950 - 2.400	24/16	2.400	5	241943
			50	8	1.050	1.950 - 2.400	24/16	2.400	5	241944
			55	8	1.050	1.950 - 2.400	24/16	2.400	5	241945
			60	8	1.050	1.950 - 2.400	24/16	2.400	5	241946
			65	8	1.050	1.950 - 2.400	24/16	2.400	5	241947

Flat faceplate 16 mm

233575



5.2.1.4 Door lock G-TS Module PT-M with 4 i.S. E94 F-16



extendable	silver	94	35	9	1.050	1.950 - 2.400	16	2.400	5	No
			40	9	1.050	1.950 - 2.400	16	2.400	5	233572
			45	9	1.050	1.950 - 2.400	16	2.400	5	233573
			50	9	1.050	1.950 - 2.400	16	2.400	5	233574
			55	9	1.050	1.950 - 2.400	16	2.400	5	233575
			60	9	1.050	1.950 - 2.400	16	2.400	5	233576
			65	9	1.050	1.950 - 2.400	16	2.400	5	233577

Flat faceplate 20 mm

233685









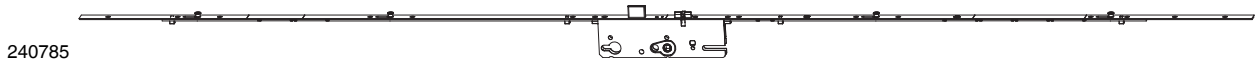

5.2.1.5 Door lock G-TS Module PT-M with 4 i.S. E94 F-20



extendable	silver	94	35	9	1.050	1.950 - 2.400	20	2.400	5	No
			40	9	1.050	1.950 - 2.400	20	2.400	5	233682
			45	9	1.050	1.950 - 2.400	20	2.400	5	233683
			50	9	1.050	1.950 - 2.400	20	2.400	5	233684
			55	9	1.050	1.950 - 2.400	20	2.400	5	233685
			60	9	1.050	1.950 - 2.400	20	2.400	5	233686
			65	9	1.050	1.950 - 2.400	20	2.400	5	233687

Top hat faceplate 24/16 mm







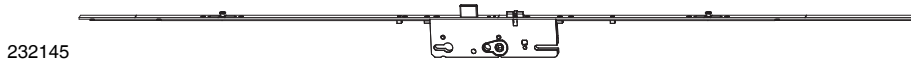

5.2.1.6 Door lock G-TS Module PT-M with 4 i.S. E94 F-24/16								L		No
extendable	silver	94	35	9	1.050	1.950 - 2.400	24/16	2.100	5	240781
			40	9	1.050	1.950 - 2.400	24/16	2.100	5	240782
			45	9	1.050	1.950 - 2.400	24/16	2.100	5	240783
			50	9	1.050	1.950 - 2.400	24/16	2.100	5	240784
			55	9	1.050	1.950 - 2.400	24/16	2.100	5	240785
			60	9	1.050	1.950 - 2.400	24/16	2.100	5	240786
			65	9	1.050	1.950 - 2.400	24/16	2.100	5	240787

5.2.2 Door lock G-TS with 2 i.S.

Flat faceplate 16 mm



5.2.2.1 Door lock G-TS Module PT-M with 2 i.S. E92 F-16								L		No
extendable	silver	92	28	8	1.050	1.900 - 2.500	16	1.500	5	232140
				10	1.050	1.900 - 2.500	16	1.500	5	232170
			35	8	1.050	1.900 - 2.500	16	1.500	5	232141
				10	1.050	1.900 - 2.500	16	1.500	5	232171
			40	8	1.050	1.900 - 2.500	16	1.500	5	232142
				10	1.050	1.900 - 2.500	16	1.500	5	232172
			45	8	1.050	1.900 - 2.500	16	1.500	5	232143
				10	1.050	1.900 - 2.500	16	1.500	5	232173
			50	8	1.050	1.900 - 2.500	16	1.500	5	232144
				10	1.050	1.900 - 2.500	16	1.500	5	232174
			55	8	1.050	1.900 - 2.500	16	1.500	5	232145
				10	1.050	1.900 - 2.500	16	1.500	5	232175
			60	8	1.050	1.900 - 2.500	16	1.500	5	232146
				10	1.050	1.900 - 2.500	16	1.500	5	232176
			65	8	1.050	1.900 - 2.500	16	1.500	5	232147
				10	1.050	1.900 - 2.500	16	1.500	5	232177

5.3 Door lock G-TS Module with HO-BO + i.S.

5.3.1 Door lock G-TS with 2 HO-BO + 2 i.S.

Flat faceplate 16 mm

234945



5.3.1.1 Door lock G-TS Module PT-M with 2 HO-BO and 2 i.S. E92 F-16



extendable	silver	92	28	8	1.050	1.950 - 2.400	16	2.400	5	No
			35	8	1.050	1.950 - 2.400	16	2.400	5	234940
			40	8	1.050	1.950 - 2.400	16	2.400	5	234941
			45	8	1.050	1.950 - 2.400	16	2.400	5	234942
			50	8	1.050	1.950 - 2.400	16	2.400	5	234943
			55	8	1.050	1.950 - 2.400	16	2.400	5	234944
			60	8	1.050	1.950 - 2.400	16	2.400	5	234945
			65	8	1.050	1.950 - 2.400	16	2.400	5	234946
										234947

Flat faceplate 20 mm

234965



5.3.1.2 Door lock G-TS Module PT-M with 2 HO-BO and 2 i.S. E92 F-20



extendable	silver	92	28	8	1.050	1.950 - 2.400	20	2.400	5	No
			35	8	1.050	1.950 - 2.400	20	2.400	5	234960
			40	8	1.050	1.950 - 2.400	20	2.400	5	234961
			45	8	1.050	1.950 - 2.400	20	2.400	5	234962
			50	8	1.050	1.950 - 2.400	20	2.400	5	234963
			55	8	1.050	1.950 - 2.400	20	2.400	5	234964
			60	8	1.050	1.950 - 2.400	20	2.400	5	234965
			65	8	1.050	1.950 - 2.400	20	2.400	5	234966
										234967

Top hat faceplate 24/16 mm

234995



5.3.1.3 Door lock G-TS Module PT-M with 2 HO-BO and 2 i.S. E92 F-24/16



extendable	silver	92	28	8	1.050	1.950 - 2.400	24/16	2.400	5	No
			35	8	1.050	1.950 - 2.400	24/16	2.400	5	234990
			40	8	1.050	1.950 - 2.400	24/16	2.400	5	234991
			45	8	1.050	1.950 - 2.400	24/16	2.400	5	234992
			50	8	1.050	1.950 - 2.400	24/16	2.400	5	234993
			55	8	1.050	1.950 - 2.400	24/16	2.400	5	234994
			60	8	1.050	1.950 - 2.400	24/16	2.400	5	234995
			65	8	1.050	1.950 - 2.400	24/16	2.400	5	234996
										234997

5.4 Door lock G-TS Module with HO-BO











5.4.1 Door lock G-TS with 2 HO-BO

Flat faceplate 16 mm

233445



5.4.1.1 Door lock G-TS Module PT-M with 2 HO-BO E92 F-16











											
		92	28	8	1.050	1.900 - 2.400	16	2.400	5	No	
modular	silver	92	28	8	1.050	1.900 - 2.400	16	2.400	5	233440	
				10	1.050	1.900 - 2.400	16	2.400	5	233450	
			35	8	1.050	1.900 - 2.400	16	2.400	5	233441	
				10	1.050	1.900 - 2.400	16	2.400	5	233451	
			40	8	1.050	1.900 - 2.400	16	2.400	5	233442	
				10	1.050	1.950 - 2.400	16	2.400	5	233452	
			45	8	1.050	1.900 - 2.400	16	2.400	5	233443	
				10	1.050	1.950 - 2.400	16	2.400	5	233453	
			50	8	1.050	1.900 - 2.400	16	2.400	5	233444	
				10	1.050	1.950 - 2.400	16	2.400	5	233454	
			55	8	1.050	1.900 - 2.400	16	2.400	5	233445	
				10	1.050	1.950 - 2.400	16	2.400	5	233455	
			60	8	1.050	1.900 - 2.400	16	2.400	5	233446	
				10	1.050	1.950 - 2.400	16	2.400	5	233456	
			65	8	1.050	1.900 - 2.400	16	2.400	5	233447	
				10	1.050	1.950 - 2.400	16	2.400	5	233457	

Flat faceplate 20 mm

233865



5.4.1.2 Door lock G-TS Module PT-M with 2 HO-BO E92 F-20

											
		92	28	8	1.050	1.950 - 2.400	20	2.400	5	No	
modular	silver	92	28	8	1.050	1.950 - 2.400	20	2.400	5	233860	
				35	8	1.050	1.950 - 2.400	20	2.400	5	233861
			40	8	1.050	1.950 - 2.400	20	2.400	5	233941	
				10	1.050	1.950 - 2.400	20	2.400	5	233862	
			45	8	1.050	1.950 - 2.400	20	2.400	5	233942	
				10	1.050	1.950 - 2.400	20	2.400	5	233863	
			50	8	1.050	1.950 - 2.400	20	2.400	5	233943	
				10	1.050	1.950 - 2.400	20	2.400	5	233864	
			55	8	1.050	1.950 - 2.400	20	2.400	5	233944	
				10	1.050	1.950 - 2.400	20	2.400	5	233865	
			60	8	1.050	1.950 - 2.400	20	2.400	5	233945	
				10	1.050	1.950 - 2.400	20	2.400	5	233866	
			65	8	1.050	1.950 - 2.400	20	2.400	5	233946	
				10	1.050	1.950 - 2.400	20	2.400	5	233867	
				8	1.050	1.950 - 2.400	20	2.400	5	233947	
				10	1.050	1.950 - 2.400	20	2.400	5	233868	

Top hat faceplate 24/16 mm

234895

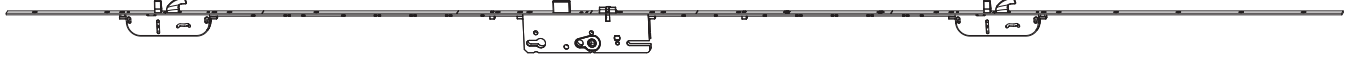

5.4.1.3 Door lock G-TS Module PT-M with 2 HO-BO E92 F-24/16



modular	silver	92						L		No
		28	8	1.050	1.950 - 2.400	24/16	2.400	5	234890	
		35	8	1.050	1.950 - 2.400	24/16	2.400	5	234891	
			10	1.050	1.950 - 2.400	24/16	2.400	5	241931	
		40	8	1.050	1.950 - 2.400	24/16	2.400	5	234892	
			10	1.050	1.950 - 2.400	24/16	2.400	5	241932	
		45	8	1.050	1.950 - 2.400	24/16	2.400	5	234893	
			10	1.050	1.950 - 2.400	24/16	2.400	5	241933	
		50	8	1.050	1.950 - 2.400	24/16	2.400	5	234894	
			10	1.050	1.950 - 2.400	24/16	2.400	5	241934	
		55	8	1.050	1.950 - 2.400	24/16	2.400	5	234895	
			10	1.050	1.950 - 2.400	24/16	2.400	5	241935	
		60	8	1.050	1.950 - 2.400	24/16	2.400	5	234896	
			10	1.050	1.950 - 2.400	24/16	2.400	5	241936	
		65	8	1.050	1.950 - 2.400	24/16	2.400	5	234897	
			10	1.050	1.950 - 2.400	24/16	2.400	5	241937	

U-faceplate 6x24x6 mm

236845

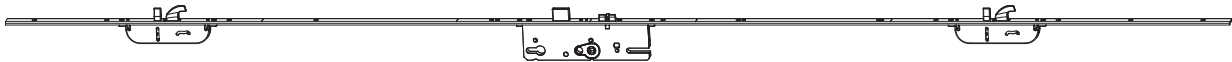

5.4.1.4 Door lock G-TS Module PT-M with 2 HO-BO E92 U-6x24x6



modular	silver	92						L		No
		28	8	1.050	1.950 - 2.400	24	2.200	5	236840	
		35	8	1.050	1.950 - 2.400	24	2.200	5	236841	
		40	8	1.050	1.950 - 2.400	24	2.200	5	236842	
		45	8	1.050	1.950 - 2.400	24	2.200	5	236843	
		50	8	1.050	1.950 - 2.400	24	2.200	5	236844	
		55	8	1.050	1.950 - 2.400	24	2.200	5	236845	
		60	8	1.050	1.950 - 2.400	24	2.200	5	236846	
		65	8	1.050	1.950 - 2.400	24	2.200	5	236847	

Flat faceplate 16 mm

233675



5.4.1.5 Door lock G-TS Module PT-M with 2 HO-BO E94 F-16







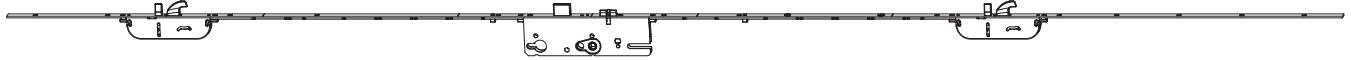

modular	silver	94						L		No
		35	9	1.050	1.950 - 2.400	16	2.400	5	233671	
		40	9	1.050	1.950 - 2.400	16	2.400	5	233672	
		45	9	1.050	1.950 - 2.400	16	2.400	5	233673	
		50	9	1.050	1.950 - 2.400	16	2.400	5	233674	
		55	9	1.050	1.950 - 2.400	16	2.400	5	233675	
		60	9	1.050	1.950 - 2.400	16	2.400	5	233676	
		65	9	1.050	1.950 - 2.400	16	2.400	5	233677	

Flat faceplate 20 mm

233755









5.4.1.6 Door lock G-TS Module PT-M with 2 HO-BO E94 F-20								L		No
modular	silver	94	35	9	1.050	1.950 - 2.400	20	2.400	5	233751
			40	9	1.050	1.950 - 2.400	20	2.400	5	233752
			45	9	1.050	1.950 - 2.400	20	2.400	5	233753
			50	9	1.050	1.950 - 2.400	20	2.400	5	233754
			55	9	1.050	1.950 - 2.400	20	2.400	5	233755
			60	9	1.050	1.950 - 2.400	20	2.400	5	233756
			65	9	1.050	1.950 - 2.400	20	2.400	5	233757

Top hat faceplate 24/16 mm

240285









5.4.1.7 Door lock G-TS Module PT-M with 2 HO-BO E94 F-24/16								L		No
modular	silver	94	35	9	1.050	1.950 - 2.400	24/16	2.400	5	240281
			40	9	1.050	1.950 - 2.400	24/16	2.400	5	240282
			45	9	1.050	1.950 - 2.400	24/16	2.400	5	240283
			50	9	1.050	1.950 - 2.400	24/16	2.400	5	240284
			55	9	1.050	1.950 - 2.400	24/16	2.400	5	240285
			60	9	1.050	1.950 - 2.400	24/16	2.400	5	240286
			65	9	1.050	1.950 - 2.400	24/16	2.400	5	240287

5.4.2 Door lock G-TS with 4 HO-BO

Flat faceplate 16 mm

235295



5.4.2.1 Door lock G-TS Module PT-M with 4 HO-BO E92 F-16								L		No
silver	92	28	8	1.050	1.950 - 2.400	16	2.400	5	235290	
		35	8	1.050	1.950 - 2.400	16	2.400	5	235291	
		40	8	1.050	1.950 - 2.400	16	2.400	5	235292	
		45	8	1.050	1.950 - 2.400	16	2.400	5	235293	
		50	8	1.050	1.950 - 2.400	16	2.400	5	235294	
		55	8	1.050	1.950 - 2.400	16	2.400	5	235295	
		60	8	1.050	1.950 - 2.400	16	2.400	5	235296	
		65	8	1.050	1.950 - 2.400	16	2.400	5	235297	

Flat faceplate 20 mm

234925

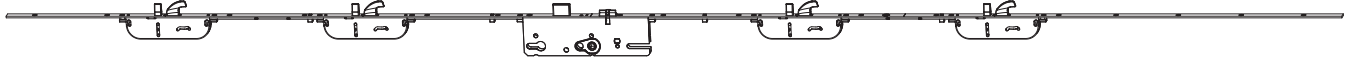

5.4.2.2 Door lock G-TS Module PT-M with 4 HO-BO E92 F-20



	92						L		No
silver	28	8	1.050	1.950 - 2.400	20	2.400	5	234920	
	35	8	1.050	1.950 - 2.400	20	2.400	5	234921	
	40	8	1.050	1.950 - 2.400	20	2.400	5	234922	
	45	8	1.050	1.950 - 2.400	20	2.400	5	234923	
	50	8	1.050	1.950 - 2.400	20	2.400	5	234924	
	55	8	1.050	1.950 - 2.400	20	2.400	5	234925	
	60	8	1.050	1.950 - 2.400	20	2.400	5	234926	
	65	8	1.050	1.950 - 2.400	20	2.400	5	234927	

Top hat faceplate 24/16 mm

234935



5.4.2.3 Door lock G-TS Module PT-M with 4 HO-BO E92 F-24/16



	92						L		No
silver	28	8	1.050	1.950 - 2.400	24/16	2.400	5	234930	
	35	8	1.050	1.950 - 2.400	24/16	2.400	5	234931	
	40	8	1.050	1.950 - 2.400	24/16	2.400	5	234932	
	45	8	1.050	1.950 - 2.400	24/16	2.400	5	234933	
	50	8	1.050	1.950 - 2.400	24/16	2.400	5	234934	
	55	8	1.050	1.950 - 2.400	24/16	2.400	5	234935	
	60	8	1.050	1.950 - 2.400	24/16	2.400	5	234936	
	65	8	1.050	1.950 - 2.400	24/16	2.400	5	234937	

5.5 Door lock G-TS Module with HO and i.S.











5.5.1 Door lock G-TS with 2 HO and 2 i.S.

Flat faceplate 16 mm

234955



5.5.1.1 Door lock G-TS Module PT-M with 2 HO and 2 i.S E92 F-16











											
		L									No
extendable	silver	92	28	8	1.050	1.950 - 2.400	16	2.400	5		234950
			35	8	1.050	1.950 - 2.400	16	2.400	5		234951
			40	8	1.050	1.950 - 2.400	16	2.400	5		234952
			45	8	1.050	1.950 - 2.400	16	2.400	5		234953
			50	8	1.050	1.950 - 2.400	16	2.400	5		234954
			55	8	1.050	1.950 - 2.400	16	2.400	5		234955
			60	8	1.050	1.950 - 2.400	16	2.400	5		234956
	65	8	1.050	1.950 - 2.400	16	2.400	5		234957		

Flat faceplate 20 mm

234985



5.5.1.2 Door lock G-TS Module PT-M with 2 HO and 2 i.S E92 F-20











											
		L									No
extendable	silver	92	28	8	1.050	1.950 - 2.400	20	2.400	5		234980
			35	8	1.050	1.950 - 2.400	20	2.400	5		234981
			40	8	1.050	1.950 - 2.400	20	2.400	5		234982
			45	8	1.050	1.950 - 2.400	20	2.400	5		234983
			50	8	1.050	1.950 - 2.400	20	2.400	5		234984
			55	8	1.050	1.950 - 2.400	20	2.400	5		234985
			60	8	1.050	1.950 - 2.400	20	2.400	5		234986
	65	8	1.050	1.950 - 2.400	20	2.400	5		234987		

Top hat faceplate 24/16 mm

235015



5.5.1.3 Door lock G-TS Module PT-M with 2 HO and 2 i.S E92 F-24/16

											
		L									No
extendable	silver	92	28	8	1.050	1.950 - 2.400	24/16	2.400	5		235010
			35	8	1.050	1.950 - 2.400	24/16	2.400	5		235011
			40	8	1.050	1.950 - 2.400	24/16	2.400	5		235012
			45	8	1.050	1.950 - 2.400	24/16	2.400	5		235013
			50	8	1.050	1.950 - 2.400	24/16	2.400	5		235014
			55	8	1.050	1.950 - 2.400	24/16	2.400	5		235015
			60	8	1.050	1.950 - 2.400	24/16	2.400	5		235016
	65	8	1.050	1.950 - 2.400	24/16	2.400	5		235017		

5.6 Door lock G-TS Module with HO

5.6.1 Door lock G-TS with 2 HO

Flat faceplate 16 mm

236835



5.6.1.1 Door lock G-TS Module PT-M with 2 HO E92 F-16



extendable	silver	92	28	8	1.050	1.950 - 2.400	16	2.400	5	236830
			35	8	1.050	1.950 - 2.400	16	2.400	5	236831
			40	8	1.050	1.950 - 2.400	16	2.400	5	236832
			45	8	1.050	1.950 - 2.400	16	2.400	5	236833
			50	8	1.050	1.950 - 2.400	16	2.400	5	236834
			55	8	1.050	1.950 - 2.400	16	2.400	5	236835
			60	8	1.050	1.950 - 2.400	16	2.400	5	236836
			65	8	1.050	1.950 - 2.400	16	2.400	5	236837

Flat faceplate 20 mm

234885



5.6.1.2 Door lock G-TS Module PT-M with 2 HO E92 F-20



extendable	silver	92	28	8	1.050	1.950 - 2.400	20	2.400	5	234880
			35	8	1.050	1.950 - 2.400	20	2.400	5	234881
			40	8	1.050	1.950 - 2.400	20	2.400	5	234882
			45	8	1.050	1.950 - 2.400	20	2.400	5	234883
			50	8	1.050	1.950 - 2.400	20	2.400	5	234884
			55	8	1.050	1.950 - 2.400	20	2.400	5	234885
			60	8	1.050	1.950 - 2.400	20	2.400	5	234886
			65	8	1.050	1.950 - 2.400	20	2.400	5	234887

Top hat faceplate 24/16 mm

234915



5.6.1.3 Door lock G-TS Module PT-M with 2 HO E92 F-24/16







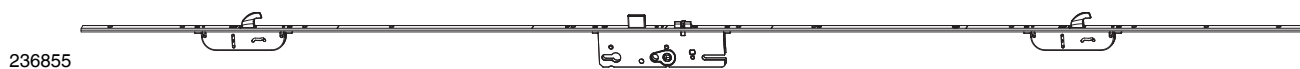

extendable	silver	92	28	8	1.050	1.950 - 2.400	24/16	2.400	5	234910
			35	8	1.050	1.950 - 2.400	24/16	2.400	5	234911
			40	8	1.050	1.950 - 2.400	24/16	2.400	5	234912
			45	8	1.050	1.950 - 2.400	24/16	2.400	5	234913
			50	8	1.050	1.950 - 2.400	24/16	2.400	5	234914
			55	8	1.050	1.950 - 2.400	24/16	2.400	5	234915
			60	8	1.050	1.950 - 2.400	24/16	2.400	5	234916
			65	8	1.050	1.950 - 2.400	24/16	2.400	5	234917

U-faceplate 6x24x6 mm



236855

5.6.1.4 Door lock G-TS Module PT-M with 2 HO E92 6x24x6 HH 1050								L		No
modular	silver	92	28	8	1.050	1.950 - 2.400	24	2.200	5	236850
			35	8	1.050	1.950 - 2.400	24	2.200	5	236851
			40	8	1.050	1.950 - 2.400	24	2.200	5	236852
			45	8	1.050	1.950 - 2.400	24	2.200	5	236853
			50	8	1.050	1.950 - 2.400	24	2.200	5	236854
			55	8	1.050	1.950 - 2.400	24	2.200	5	236855
			60	8	1.050	1.950 - 2.400	24	2.200	5	236856
			65	8	1.050	1.950 - 2.400	24	2.200	5	236857

5.7 Door lock G-TS Module with BO and i.S.

5.7.1 Door lock G-TS with 2 BO and 2 i.S.

Flat faceplate 16 mm

236825



5.7.1.1 Door lock G-TS Module PT-M with 2 BO and 2 i.S E92 F-16



extendable	silver	92	28	8	1.050	1.950 - 2.400	16	2.400	5	No
			35	8	1.050	1.950 - 2.400	16	2.400	5	236820
			40	8	1.050	1.950 - 2.400	16	2.400	5	236821
			45	8	1.050	1.950 - 2.400	16	2.400	5	236822
			50	8	1.050	1.950 - 2.400	16	2.400	5	236823
			55	8	1.050	1.950 - 2.400	16	2.400	5	236824
			60	8	1.050	1.950 - 2.400	16	2.400	5	236825
			65	8	1.050	1.950 - 2.400	16	2.400	5	236826
										236827

Flat faceplate 20 mm

234975



5.7.1.2 Door lock G-TS Module PT-M with 2 BO and 2 i.S E92 F-20



extendable	silver	92	28	8	1.050	1.950 - 2.400	20	2.400	5	No
			35	8	1.050	1.950 - 2.400	20	2.400	5	234970
			40	8	1.050	1.950 - 2.400	20	2.400	5	234971
			45	8	1.050	1.950 - 2.400	20	2.400	5	234972
			50	8	1.050	1.950 - 2.400	20	2.400	5	234973
			55	8	1.050	1.950 - 2.400	20	2.400	5	234974
			60	8	1.050	1.950 - 2.400	20	2.400	5	234975
			65	8	1.050	1.950 - 2.400	20	2.400	5	234976
										234977

Top hat faceplate 24/16 mm

235005



5.7.1.3 Door lock G-TS Module PT-M with 2 BO and 2 i.S E92 F-24/16



extendable	silver	92	28	8	1.050	1.950 - 2.400	24/16	2.400	5	No
			35	8	1.050	1.950 - 2.400	24/16	2.400	5	235000
			40	8	1.050	1.950 - 2.400	24/16	2.400	5	235001
			45	8	1.050	1.950 - 2.400	24/16	2.400	5	235002
			50	8	1.050	1.950 - 2.400	24/16	2.400	5	235003
			55	8	1.050	1.950 - 2.400	24/16	2.400	5	235004
			60	8	1.050	1.950 - 2.400	24/16	2.400	5	235005
			65	8	1.050	1.950 - 2.400	24/16	2.400	5	235006
										235007

5.8 Door lock G-TS Module with BO

5.8.1 Door lock G-TS with 2 BO

Flat faceplate 16 mm

236815



5.8.1.1 Door lock G-TS Module PT-M with 2 BO E92 F-16

modular	silver	92	28	8	1.050	1.950 - 2.400	16	2.400	5	236810
			35	8	1.050	1.950 - 2.400	16	2.400	5	236811
			40	8	1.050	1.950 - 2.400	16	2.400	5	236812
			45	8	1.050	1.950 - 2.400	16	2.400	5	236813
			50	8	1.050	1.950 - 2.400	16	2.400	5	236814
			55	8	1.050	1.950 - 2.400	16	2.400	5	236815
			60	8	1.050	1.950 - 2.400	16	2.400	5	236816
			65	8	1.050	1.950 - 2.400	16	2.400	5	236817

Flat faceplate 20 mm

234875



5.8.1.2 Door lock G-TS Module PT-M with 2 BO E92 F-20

modular	silver	92	28	8	1.050	1.950 - 2.400	20	2.400	5	234870
			35	8	1.050	1.950 - 2.400	20	2.400	5	234871
			40	8	1.050	1.950 - 2.400	20	2.400	5	234872
			45	8	1.050	1.950 - 2.400	20	2.400	5	234873
			50	8	1.050	1.950 - 2.400	20	2.400	5	234874
			55	8	1.050	1.950 - 2.400	20	2.400	5	234875
			60	8	1.050	1.950 - 2.400	20	2.400	5	234876
			65	8	1.050	1.950 - 2.400	20	2.400	5	234877

Top hat faceplate 24/16 mm

234905



5.8.1.3 Door lock G-TS Module PT-M with 2 BO E92 F-24/16

modular	silver	92	28	8	1.050	1.950 - 2.400	24/16	2.400	5	234900
			35	8	1.050	1.950 - 2.400	24/16	2.400	5	234901
			40	8	1.050	1.950 - 2.400	24/16	2.400	5	234902
			45	8	1.050	1.950 - 2.400	24/16	2.400	5	234903
			50	8	1.050	1.950 - 2.400	24/16	2.400	5	234904
			55	8	1.050	1.950 - 2.400	24/16	2.400	5	234905
			60	8	1.050	1.950 - 2.400	24/16	2.400	5	234906
			65	8	1.050	1.950 - 2.400	24/16	2.400	5	234907

U-faceplate 6x24x6 mm

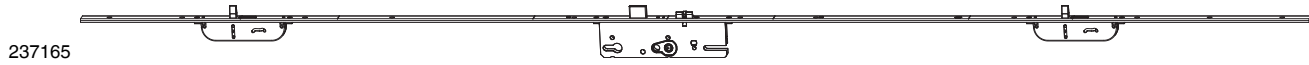

237165

5.8.1.4 Door lock G-TS Module PT-M with 2 BO E92 U-6x24x6								L		No
modular	silver	92	28	8	1.050	1.950 - 2.400	24	2.200	5	237160
			35	8	1.050	1.950 - 2.400	24	2.200	5	237161
			40	8	1.050	1.950 - 2.400	24	2.200	5	237162
			45	8	1.050	1.950 - 2.400	24	2.200	5	237163
			50	8	1.050	1.950 - 2.400	24	2.200	5	237164
			55	8	1.050	1.950 - 2.400	24	2.200	5	237165
			60	8	1.050	1.950 - 2.400	24	2.200	5	237166
			65	8	1.050	1.950 - 2.400	24	2.200	5	237167

Flat faceplate 16 mm

240795



5.8.1.5 Door lock G-TS Module PT-M with 2 BO E94 F-16								L		No
modular	silver	94	35	9	1.050	1.950 - 2.400	16	2.400	5	240791
			40	9	1.050	1.950 - 2.400	16	2.400	5	240792
			45	9	1.050	1.950 - 2.400	16	2.400	5	240793
			50	9	1.050	1.950 - 2.400	16	2.400	5	240794
			55	9	1.050	1.950 - 2.400	16	2.400	5	240795
			60	9	1.050	1.950 - 2.400	16	2.400	5	240796
			65	9	1.050	1.950 - 2.400	16	2.400	5	240797

Flat faceplate 20 mm

240805

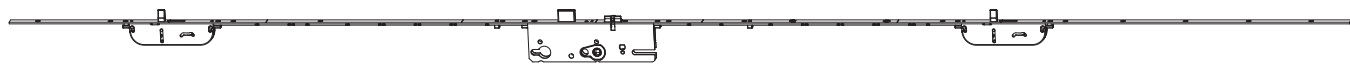

5.8.1.6 Door lock G-TS Module PT-M with 2 BO E94 F-20								L		No
modular	silver	94	35	9	1.050	1.950 - 2.400	20	2.400	5	240801
			40	9	1.050	1.950 - 2.400	20	2.400	5	240802
			45	9	1.050	1.950 - 2.400	20	2.400	5	240803
			50	9	1.050	1.950 - 2.400	20	2.400	5	240804
			55	9	1.050	1.950 - 2.400	20	2.400	5	240805
			60	9	1.050	1.950 - 2.400	20	2.400	5	240806
			65	9	1.050	1.950 - 2.400	20	2.400	5	240807

Top hat faceplate 24/16 mm

240815



**5.8.1.7 Door lock G-TS Module PT-M
with 2 BO E94 F-24/16**



modular	silver	94	35	9	1.050	1.950 - 2.400	24/16	2.400	5	No
			40	9	1.050	1.950 - 2.400	24/16	2.400	5	240811
			45	9	1.050	1.950 - 2.400	24/16	2.400	5	240812
			50	9	1.050	1.950 - 2.400	24/16	2.400	5	240813
			55	9	1.050	1.950 - 2.400	24/16	2.400	5	240814
			60	9	1.050	1.950 - 2.400	24/16	2.400	5	240815
			65	9	1.050	1.950 - 2.400	24/16	2.400	5	240816
										240817

U-faceplate 6x24x6 mm

237174

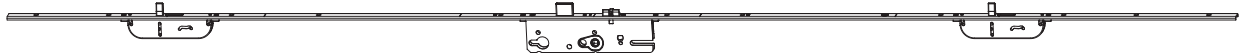

**5.8.1.8 Door lock G-TS Module PT-M
with 2 BO E94 U-6x24x6**



modular	silver	94	45	9	1.050	1.950 - 2.400	24	2.200	5	No
			50	9	1.050	1.950 - 2.400	24	2.200	5	237173
										237174

5.9 Door lock G-TS Module without i.S.

5.9.1 Door lock G-TS without i.S.

Flat faceplate 16 mm

233485

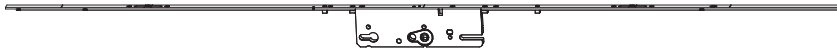

5.9.1.1 Door lock G-TS Module PT-M without i.S. E92 F-16



2-sashed	silver	92						L	No	No
		28	8	1.050	1.900 - 2.500	16	1.500	5	233480	
		35	8	1.050	1.900 - 2.500	16	1.500	5	233481	
		40	8	1.050	1.900 - 2.500	16	1.500	5	233482	
		45	8	1.050	1.900 - 2.500	16	1.500	5	233483	
		50	8	1.050	1.900 - 2.500	16	1.500	5	233484	
		55	8	1.050	1.900 - 2.500	16	1.500	5	233485	
		60	8	1.050	1.900 - 2.500	16	1.500	5	233486	
		65	8	1.050	1.900 - 2.500	16	1.500	5	233487	

**MACO
PROTECT**



G-TS Lever operated Door Lock



6 G-TA Lever Operated Automatic Door Lock

6.1	Door lock G-TA with i.S	136
6.1.1	Door lock G-TA with 4 i.S	136

6 G-TA Lever Operated Automatic Door Lock





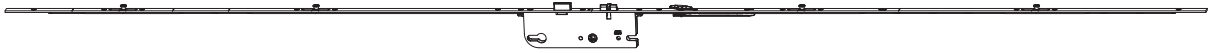

6.1 Door lock G-TA with i.S

6.1.1 Door lock G-TA with 4 i.S

243683







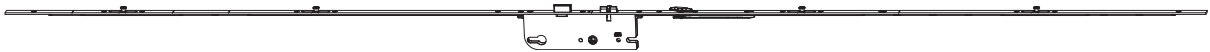

6.1.1.1 Door lock G-TA with 4 i.S E92 F-16

										L		No
extendable	silver	92	28	8	1.050	1.950 - 2.150	16	2.150	5			243680
			35	8	1.050	1.950 - 2.150	16	2.150	5			243681
			40	8	1.050	1.950 - 2.150	16	2.150	5			243682
			45	8	1.050	1.950 - 2.150	16	2.150	5			243683
			50	8	1.050	1.950 - 2.150	16	2.150	5			243684

243693



6.1.1.2 Door lock G-TA with 4 i.S E92 F-24/6

										L		No
extendable	silver	92	28	8	1.050	1.950 - 2.150	24/16	2.150	5			243690
			35	8	1.050	1.950 - 2.150	24/16	2.150	5			243691
			40	8	1.050	1.950 - 2.150	24/16	2.150	5			243692
			45	8	1.050	1.950 - 2.150	24/16	2.150	5			243693
			50	8	1.050	1.950 - 2.150	24/16	2.150	5			243694







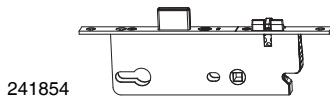

7 Z-RS - Mortise Door Lock

7.1	Door lock Z-RS	138
7.1.1	Door lock Z-RS E92 F-16	138
7.1.2	Door lock Z-RS E92 F-24	138
7.1.3	Door lock Z-RS E92 U-6x24x6	138
7.2	Door lock Z-RS with roller latch	139
7.2.1	Door lock Z-RS with roller latch E92 F-16	139
7.2.2	Door lock Z-RS with roller latch E92 F-24	139
7.2.3	Door lock Z-RS with roller latch E92 U-6x24x6	139



7 Z-RS - Mortise Door Lock

7.1 Door lock Z-RS



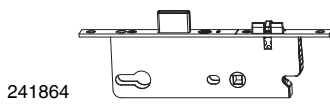

7.1.1 Door lock Z-RS E92 F-16					L		No
silver	92	25	8	16	240	10	241850
		35	8	16	240	10	241852
		45	8	16	240	10	241854

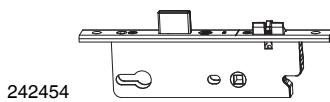

7.1.2 Door lock Z-RS E92 F-24					L		No
silver	92	25	8	24	240	10	241860
		35	8	24	240	10	241862
		45	8	24	240	10	241864



7.1.3 Door lock Z-RS E92 U-6x24x6					L		No
silver	92	25	8	24	240	10	242450
		35	8	24	240	10	242452
		45	8	24	240	10	242454

**7.2 Door lock Z-RS
with roller latch**

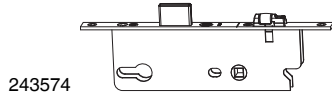

**7.2.1 Door lock Z-RS
with roller latch E92 F-16**

with roller latch

silver



92	25	8	16	240	10
	35	8	16	240	10
	45	8	16	240	10

No

243570
243572
243574

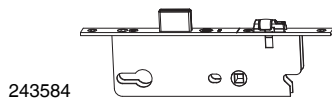

**7.2.2 Door lock Z-RS
with roller latch E92 F-24**

with roller latch

silver



92	25	8	24	240	10
	35	8	24	240	10
	45	8	24	240	10

No

243580
243582
243584

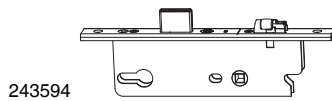

**7.2.3 Door lock Z-RS
with roller latch E92 U-6x24x6**

silver



92	25	8	24	240	10
	35	8	24	240	10
	45	8	24	240	10

No

243590
243592
243594

**MACO
PROTECT**



Z-RS - Mortise Door Lock



8 B-TV - Balcony Door Lock

8.1	Door lock B-TV MULTI MATIC	142
8.1.1	Door lock B-TV MULTI MATIC PC	142
8.1.2	Door lock B-TV MULTI MATIC RC	142
8.2	Door lock B-TV MULTI TREND	143
8.2.1	Door lock B-TV with i.S. PC extendable	143
8.2.2	Door lock B-TV with i.S. RC extendable	143
8.2.3	Door lock B-TV with VZ PC extendable	143
8.2.4	Door lock B-TV with VZ RC extendable	144
8.2.5	Door lock B-TV with i.S. PC FHH	144

8 B-TV - Balcony Door Lock

8.1 Door lock B-TV MULTI MATIC

8.1.1 Door lock B-TV MULTI MATIC PC

203833



8.1.1.1 Door lock B-TV MULTI MATIC PC E92



									No
silver	MM fixed handle height	25	8	1.050	2	92	1.347	5	203828
		28	8	1.050	2	92	1.347	5	203696
		35	8	1.050	2	92	1.347	5	203829
		40	8	1.050	2	92	1.347	5	203830
		45	8	1.050	2	92	1.347	5	203831
		50	8	1.050	2	92	1.347	5	203832
		55	8	1.050	2	92	1.347	5	203833

8.1.2 Door lock B-TV MULTI MATIC RC

203841



8.1.2.1 Door lock B-TV MULTI MATIC RC E94











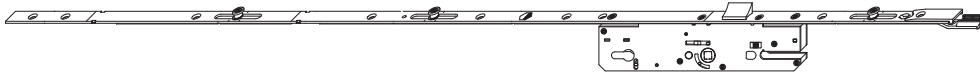



									No
silver	MM fixed handle height	35	8	1.050	2	94	1.347	5	203841
		40	8	1.050	2	94	1.347	5	203842
		45	8	1.050	2	94	1.347	5	203843
		50	8	1.050	2	94	1.347	5	203844
		55	8	1.050	2	94	1.347	5	203845

8.2 Door lock B-TV MULTI TREND

8.2.1 Door lock B-TV with i.S. PC extendable

220298









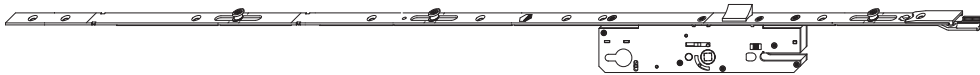



8.2.1.1 Door lock B-TV with i.S. PC E92												
silver	extendable	25	8	1.050	3	92	1.460	5	No			
		28	8	1.050	3	92	1.460	5	201455			
		35	8	1.050	3	92	1.460	5	59900			
		40	8	1.050	3	92	1.460	5	220298			
		45	8	1.050	3	92	1.460	5	220299			
		50	8	1.050	3	92	1.460	5	59901			
		55	8	1.050	3	92	1.460	5	57179			
									201459			

8.2.2 Door lock B-TV with i.S. RC extendable

201457









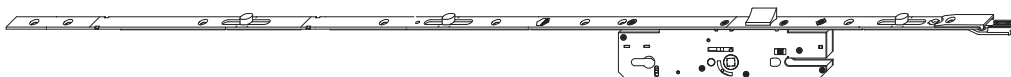



8.2.2.1 Door lock B-TV with i.S. RC E94												
silver	extendable	28	8	1.050	3	94	1.460	5	No			
		35	8	1.050	3	94	1.460	5	201457			
		40	8	1.050	3	94	1.460	5	55484			
		45	8	1.050	3	94	1.460	5	55485			
		50	8	1.050	3	94	1.460	5	55486			
		55	8	1.050	3	94	1.460	5	57181			
									55487			

8.2.3 Door lock B-TV with VZ PC extendable

58188



8.2.3.1 Door lock B-TV with i.S. PC E92												
silver	extendable	25	8	1.050	3	92	1.460	5	No			
		28	8	1.050	3	92	1.460	5	58188			
		35	8	1.050	3	92	1.460	5	55395			
		40	8	1.050	3	92	1.460	5	55396			
		45	8	1.050	3	92	1.460	5	55397			
		55	8	1.050	3	92	1.460	5	55398			
									55399			

8.2.4 Door lock B-TV with VZ RC extendable

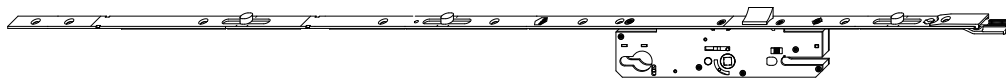

59391

8.2.4.1 Door lock B-TV with VZ RC E94



silver	extendable	28	8	1.050	3	94	1.460	5	59391
		35	8	1.050	3	94	1.460	5	55146
		40	8	1.050	3	94	1.460	5	55147
		45	8	1.050	3	94	1.460	5	55148
		55	8	1.050	3	94	1.460	5	55149

8.2.5 Door lock B-TV with i.S. PC FHH



204048

8.2.5.1 Door lock B-TV with i.S. PC E92 FHH

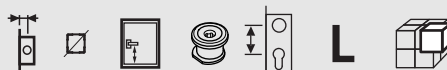

silver	fixed handle height	25	8	1.050	3	92	1.460	5	204060
		28	8	1.050	3	92	1.460	5	204048
		35	8	1.050	3	92	1.460	5	204049
		40	8	1.050	3	92	1.460	5	204050
		45	8	1.050	3	92	1.460	5	204051
		50	8	1.050	3	92	1.460	5	204052
		55	8	1.050	3	92	1.460	5	204053



9 Striker plates

9.1	Striker plates timber	146
9.1.1	Striker plates 4mm air gap 13 mm offset	146
9.1.2	Striker plates 4 mm air gap 10 mm offset	149
9.1.3	Striker plates 4 mm air gap 13 mm offset	151
9.1.4	Striker 4 mm air gap 15 mm offset	153
9.1.5	Striker plates 12 mm air gap 9 mm offset	154
9.1.6	Striker plates 12 mm air gap 10 mm offset	157
9.1.7	Striker plates 12 mm air gap 13 mm offset	159
9.2	Striker plates opposite hardware groove	162
9.2.1	Latch and deadbolt striker plates	162
9.2.2	Striker plates VZ	162
9.2.3	Striker plates i.S.	162
9.2.4	Hook and bolt striker plates	162
9.2.5	Latch and deadbolt angled striker plates	162
9.2.6	Latch striker plates	162
9.2.7	Latch striker plates B-TV	163
9.3	Single piece door striker for timber	164
9.3.1	Single piece door striker for timber U-6x24x6 13 mm offset	164
9.3.2	Single piece door striker for timber U-8x28x8 13 mm offset	165
9.3.3	Single piece door striker for timber U-8x28x12 13 mm offset	165
9.3.4	Single piece door striker for timber U-10x30x10 15 mm offset	166
9.4	Striker plates PVC	167
9.4.1	Striker plates & single-piece door strikers for Z-TA automatic/comfort PT	167
9.4.2	Striker plates & single-piece door strikers for G-TS/Z-TS module PT-M	168
9.4.3	Striker plates for Z-TF PT	169
9.4.4	Single piece door strikers for Z-TF PT	170
9.5	Striker plates ALU	171
9.5.1	Striker plates ALU 3 mm	171
9.5.2	Single piece door striker ALU 6 mm	171
9.6	Single piece door striker for PVC	173
9.6.1	Single piece door striker ALU 3 mm	173
9.6.2	Single piece door striker ALU 6 mm	173

9 Striker plates

9.1 Striker plates timber

9.1.1 Striker plates 4mm air gap 13 offset



9.1.1.1 Latch and deadbolt striker plates			L	W	H		No
silver	right	latch and deadbolt striker Z-TA 4mm air gap 9mm offset	220	18	8	20	219231
	left	latch and deadbolt striker Z-TA 4mm air gap 9mm offset	220	18	8	20	219232
		latch and deadbolt striker for 4 mm air gap	208	18	8	50	29776^{1,2}

¹ Compatible with recess cover cap 43524

² Compatible with clip-on end cap 43718 for timber 12mm air gap

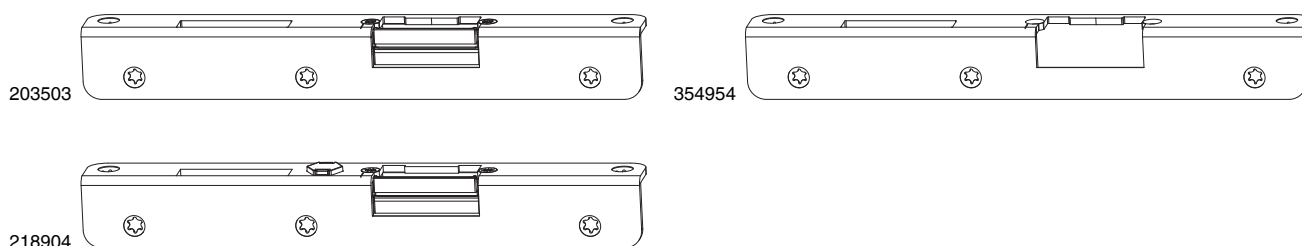

9.1.1.2 Latch and deadbolt right-angled latch plates			L			No
silver	right	right-angled latch plate for latch and deadbolt striker with receiver insert for 4 mm air gap	250	32 x 25	20	203502
		latch and deadbolt angled striker plate for electric opener for timber	250	32 x 25	20	354952
		latch and deadbolt angled striker plate for electric opener for 4 mm air gap - 1 mm gasket-compression	250	15 x 25	20	360112
		right-angled latch plate for latch and deadbolt striker Z-TA 4mm air gap 9mm offset	250	32 x 25	20	218903
	left	right-angled latch plate for latch and deadbolt striker with receiver insert for 4 mm air gap	250	32 x 25	20	203503
		latch and deadbolt angled striker plate for electric opener for timber	250	32 x 25	20	354954
		latch and deadbolt angled striker plate for electric opener for 4 mm air gap - 1 mm gasket-compression	250	15 x 25	20	360113
		right-angled latch plate for latch and deadbolt striker Z-TA for 4 mm air gap, 9 mm offset	250	32 x 25	20	218904



9.1.1.3 Latch and deadbolt striker plates for roller latch			L	W	H		No
silver	right	latch and deadbolt striker for roller latch for 4 mm air gap	208	18	8	50	59421^{1,2}
	left	latch and deadbolt striker for roller latch for 4 mm air gap	208	18	8	10	59420^{1,2}

¹ Compatible with recess cover cap 43524

² Compatible with clip-on end cap 43718 for timber 12mm air gap



9.1.1.4 Striker VZ for 4 mm air gap			L	W	H		No
silver	for 4 mm air gap		90	18	8	200	30545



9.1.1.5 Striker i.S. for 4 mm air gap			L	W	H		No
silver	right	for 4 mm air gap - 1 mm gasket-compression	90	18	8	100	96305 ^{1,2}
		for 4 mm air gap angled screw-fixing	90	18	8	100	96565 ¹
	left	for 4 mm air gap - 1 mm gasket-compression	90	18	8	100	96306 ^{1,2}
		for 4 mm air gap angled screw-fixing	90	18	8	100	96566 ¹

¹ Use left-handed striker plates for right-handed doors and vice versa!

² Not compliant with EN 1627



9.1.1.6 Hook and bolt striker plates			L	W	H		No
silver	hook and bolt striker for 4 mm air gap		180	18	8	20	207862 ^{1,2}

¹ Compatible with recess cover cap 358024

² Compatible with clip-on end cap 43718 for timber 12mm air gap



9.1.1.7 Latch and deadbolt striker plates			L	W	H		No
silver	right	latch and bolt striker 4mm air gap 9mm offset	180	18	8	20	218939
	left	latch and bolt striker 4mm air gap 9mm offset	180	18	8	20	218940

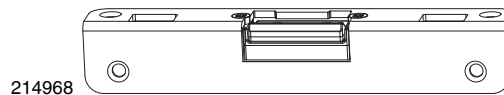
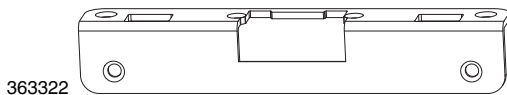

9.1.1.8 Latch and deadbolt right-angled latch plates			L			No
silver	MF-BO right-angled latch plate without latch element 4mm air gap 10mm offset		190	32 x 25	20	363322
	MF-BO right-angled latch plate with latch element 4mm air gap 10mm offset		190	32 x 25	20	214968



9.1.1.9 Latch striker plates for multi-functional latch			L	W	H		No
silver	latch striker for MF 4mm air gap 9mm offset		120	18	8	20	210501 ¹

¹ Compatible with clip-on end cap 360074 for 12mm air gap

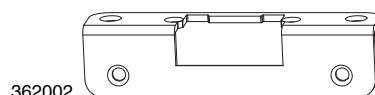
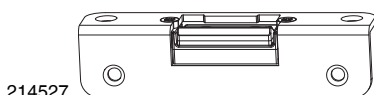



9.1.1.10 Right-angled latch plates for multi-functional latch			L			No
silver	latch striker for MF with latch-receiver insert for 4 mm air gap		130	32 x 25	20	214527
	latch striker for e-opener for 4 mm air gap		130	32 x 25	20	362002

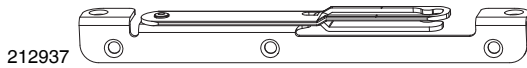

9.1.1.11 Latch striker plates B-TV			L	W	H		No
silver	for 4 mm air gap adjustable		90	18	8	50	94118 ¹

¹ Compatible with clip-on end cap 43718 for timber 12mm air gap





9.1.1.12 Striker plates for door turn-restrictor			L			No
silver	right	door turn-restrictor striker 4mm air gap 9mm offset	200	20 x 18	20	212936
	left	door turn-restrictor striker 4mm air gap 9mm offset	200	20 x 18	20	212937

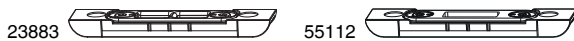

9.1.1.13 Shootbolt striker plates for shootbolt protrusion 10 x 5 mm			L	W	H		No
silver	finger bolt striker for 4 mm air gap		120	18	8	20	26799 ¹
	deadbolt striker with s slots for 4 mm air gap		120	18	8	20	50576

¹ Compatible with recess cover cap 41250



9.1.1.14 Shootbolt striker plates for shootbolt protrusion 8 x 4 mm			L	W	H		No
silver	for 4 mm air gap 2 slots		90	18	8	100	23883 ¹
	for 4 mm air gap 1 slot		90	18	8	100	55112 ¹

¹ Compatible with clip-on end cap 43718 for timber 12mm air gap

9.1.2 Striker plates 4 mm air gap 10 mm offset



9.1.2.1 Latch and deadbolt striker plates			L	W	H		No
silver	right	latch and deadbolt striker Z-TA 4mm air gap 10mm offset	220	20	8	20	219235
	left	latch and deadbolt striker Z-TA 4mm air gap 10mm offset	220	20	8	20	219236
		latch and deadbolt striker for 4 mm air gap	208	20	8	50	29787 ^{1,2}

¹ Compatible with clip-on end cap 354358 for 12mm air gap

² Compatible with recess cover cap 43524

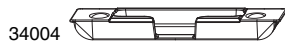

9.1.2.2 Striker plates VZ for 4 mm air gap			L	W	H		No
silver		for 4 mm air gap angled screw-fixing	90	20	8	50	34004 ¹

¹ Compatible with clip-on end cap 354358 for 12mm air gap



9.1.2.3 Striker plates i.S. for 4 mm air gap			L	W	H		No
silver	right	for 4 mm air gap angled screw-fixing	90	20	8	100	96845 ¹
	left	for 4 mm air gap angled screw-fixing	90	20	8	100	96846 ¹

¹ Use left-handed striker plates for right-handed doors and vice versa!

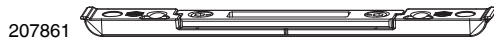

9.1.2.4 Hook and bolt striker plates			L	W	H		No
silver		hook and bolt striker for 4 mm air gap	180	20	8	20	207861 ^{1,2}

¹ Compatible with recess cover cap 358024

² Compatible with clip-on end cap 354358 for 12mm air gap



9.1.2.5 Latch and deadbolt striker plates			L			No
latch and bolt striker right 4mm air gap 10mm offset silver		right	180	8 x 20	20	218943
latch and bolt striker left 4mm air gap 10mm offset silver		left	180	8 x 20	20	218944

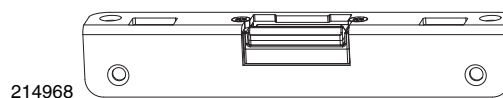
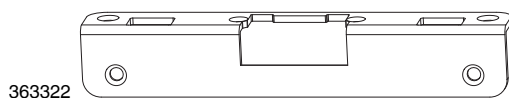

9.1.2.6 Right-angled latch plates for latch-bolt			L			No
MF-BO right-angled latch plate without latch element 4mm air gap 10mm offset silver			190	32 x 25	20	363322
MF-BO right-angled latch plate with latch element 4mm air gap 10mm offset silver			190	32 x 25	20	214968



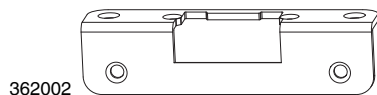

9.1.2.7 Latch striker plates for multi-functional latch		L	W	H		No
silver	latch striker for 4 mm air gap	120	20	8	20	210502 ¹

¹ Compatible with clip-on end cap 354358 for 12mm air gap



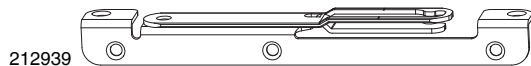

9.1.2.8 Right-angled latch plates for multi-functional latch		L			No
latch striker for e-opener for 4 mm air gap silver		130	32 x 25	20	362002



9.1.2.9 Striker plates for door turn-restrictor		L			No	
door turn-restrictor striker right 4mm air gap 10mm offset silver		right	200	20 x 20	20	212938
door turn-restrictor striker left 4mm air gap 10mm offset silver		left	200	20 x 20	20	212939



9.1.2.10 Shootbolt striker plates for shootbolt protrusion 10 x 5 mm		L			No
Finger Bolt Striker for 4mm air gap		120	20	20	29788 ^{1,2}

¹ Compatible with recess cover cap 41250

² Compatible with clip-on end cap 354358 for 12mm air gap

9.1.3 Striker plates 4 mm air gap 13 mm offset

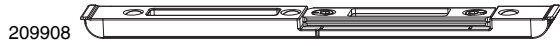

9.1.3.1 Latch and deadbolt striker plates			L	W	H		N ^o
silver	right	latch and deadbolt striker for 4 mm air gap, 13 mm offset	208	22	8	50	209907
	left	latch and deadbolt striker for 4 mm air gap, 13 mm offset	208	22	8	50	209908



9.1.3.2 Latch and deadbolt right-angled latch plates			L			N ^o
right-angled latch plate for latch and deadbolt striker Z-TA right 4mm air gap 13mm offset silver	right		250	8 x 30	20	226811 ¹
right-angled latch plate for latch and deadbolt striker Z-TA left 4mm air gap 13mm offset silver	left		250	8 x 30	5	226811 ¹
latch and deadbolt right-angled latch plate right 4mm air gap 13mm offset silver	right		250	8 x 24	20	214455 ^{2,3}
latch and deadbolt right-angled latch plate left 4mm air gap 13mm offset silver	left		250	8 x 24	20	214456 ^{2,3}
right-angled latch plate for latch and deadbolt striker Z-TA right for timber silver	right		250	8 x 24	20	218901 ^{2,3}
latch and deadbolt angled striker plate for electric opener right 4mm air gap 13mm offset silver	right		250	32 x 25	20	360614
right-angled latch plate for latch and deadbolt striker Z-TA left for timber silver	left		250	8 x 24	20	218902 ^{2,3}
latch and deadbolt angled striker plate for electric opener left 4mm air gap 13mm offset silver	left		250	32 x 25	20	360615

¹ Compatible with clip-on end cap 369691 for 12 mm air gap.

² Compatible with clip-on end cap 362920 for 12mm air gap.

³ Compatible with recess cover cap 360397

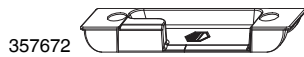

9.1.3.3 Striker plates VZ for 4 mm air gap			L	W	H		N ^o
silver	right	for 4 mm air gap, 13 mm offset - 1 mm gasket-compression	90	22	8	200	357671
	left	for 4 mm air gap, 13 mm offset - 1 mm gasket-compression	90	22	8	200	357672

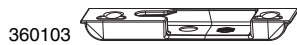

9.1.3.4 Striker plates i.S. for 4 mm air gap			L	W	H		N ^o
silver	right	for 4 mm air gap, 13 mm offset angled screw-fixing	90	22	8	100	357673 ¹
		for 4 mm air gap, 13 mm offset angled screw-fixing - 1 mm gasket-compression	90	22	8	100	360102 ^{1,2}
	left	for 4 mm air gap, 13 mm offset angled screw-fixing	90	22	8	100	357674 ¹
		for 4 mm air gap, 13 mm offset angled screw-fixing - 1 mm gasket-compression	90	22	8	100	360103 ^{1,2}

¹ Use left-handed striker plates for right-handed doors and vice versa!

² Not compliant with EN 1627



9.1.3.5 Hook and bolt striker plates			L	W	H		N ^o
hook and bolt striker 4mm air gap 13mm offset			180	22	8	20	209909 ¹

¹ Compatible with recess cover cap 358024



214459

9.1.3.6 Hook and bolt right-angled latch plates

	L	a	b		N ^o
MF-HO striker 4mm air gap 13mm offset silver	180	8 x 30	5		227065 ¹
hook and bolt striker 4mm air gap 13mm offset silver	180	8 x 24	20		214459 ²

¹ Compatible with clip-on end cap 369691 for 12 mm air gap.
² Compatible with clip-on end cap 362920 for 12mm air gap.



214457

9.1.3.7 Latch and deadbolt right-angled latch plates

	L	a	b		N ^o
MF-BO right-angled latch plate with latch element 4mm air gap 13mm offset silver	250	8 x 24	20		214457 ^{1,2,3}

¹ Compatible with clip-on end cap 362920 for 12mm air gap.
² Compatible with recess cover cap 363959
³ Compatible with recess cover cap 364326



211597

9.1.3.8 Latch striker plates for multi-functional latch

	L	W	H		N ^o
silver latch striker 4mm air gap 13mm offset	180	22	8	20	211597



214458

9.1.3.9 Right-angled latch plates for multi-functional latch

	L	a	b		N ^o
right-angled latch plate for MF 4mm air gap 13mm offset silver	130	8 x 24	20		214458 ¹

¹ Compatible with clip-on end cap 362920 for 12mm air gap.

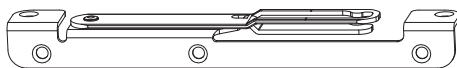

216864

9.1.3.10 Striker plates for door turn-restrictor

	L	a	b		N ^o
door turn-restrictor striker right 4mm air gap 13mm offset silver	right	200	20 x 24	20	216863
door turn-restrictor striker left 4mm air gap 13mm offset silver	left	200	20 x 24	20	216864



209911



209912

9.1.3.11 Shootbolt striker plates for shootbolt protrusion 10 x 5 mm

	L	W	H		N ^o
silver finger bolt striker 4mm air gap 13mm offset	180	22	8	20	209911
deadbolt striker with s slots 4mm air gap 13mm offset	180	22	8	20	209912



209338



9.1.3.12 Shootbolt striker plates for shootbolt protrusion 8 x 4 mm

	L	W	H		N ^o
silver for 4 mm air gap, 13 mm offset 2 slots	90	22	9	100	209338

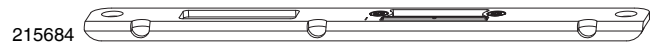
9.1.4 Striker 4 mm air gap 15 mm offset



9.1.4.1 Latch and deadbolt right-angled latch plates

	L			No
right-angled latch plate for latch and deadbolt striker Z-TA right 4mm air gap 15mm offset silver	250	8 x 26	20	219376¹
right-angled latch plate for latch and deadbolt striker Z-TA left 4mm air gap 15mm offset silver left	250	8 x 26	20	219378¹
right-angled latch plate for latch and deadbolt striker with receiver insert right for timber silver	250	8 x 26	20	215683¹
right-angled latch plate for latch and deadbolt striker with receiver insert left for timber silver	250	8 x 26	20	215684¹

¹ Compatible with recess cover cap 360397

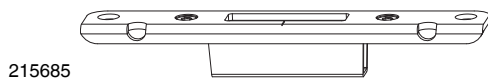

9.1.4.2 Hook and bolt right-angled latch plates

	L			No
hook and bolt striker 4mm air gap 15mm offset silver	180	8 x 26	20	215685

9.1.5 Striker plates 12 mm air gap 9 mm offset

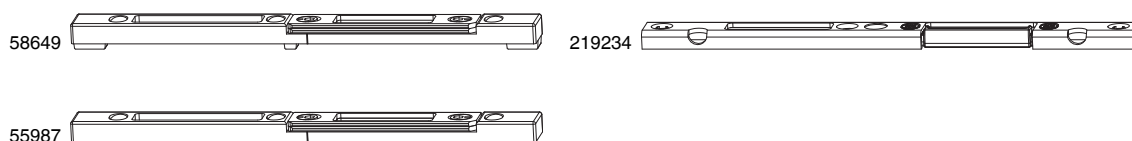

9.1.5.1 Latch and deadbolt striker plates			L	W	H		No	
silver	right	latch and deadbolt striker for hardware groove 6/8/4	208	18	9	50	58646¹	
		latch and deadbolt striker for hardware groove 7/8/4	208	18	9	20	58648¹	
		latch and deadbolt striker Z-TA 12mm air gap 9mm offset	220	18	8	20	219233	
	left	latch and deadbolt striker for hardware groove 6/8/4	208	18	9	50	58647¹	
		latch and deadbolt striker for hardware groove 7/8/4	208	18	9	20	58649¹	
		latch and deadbolt striker Z-TA 12mm air gap 9mm offset	220	18	8	20	219234	
			latch and deadbolt striker Euro-rebate	208	18	9	50	55987¹

¹ Compatible with recess cover cap 43524

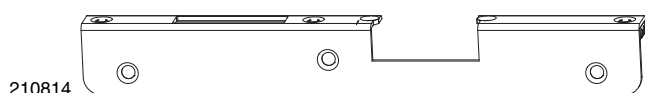

9.1.5.2 Latch and deadbolt right-angled latch plates			L			No
silver	right	right-angled latch plate for latch and deadbolt striker with receiver insert Euro-rebate 18 mm	250	32 x 18	20	210809
		latch and deadbolt angled striker plate for electric opener Euro-rebate 18 mm	250	32 x 18	20	210813
	left	right-angled latch plate for latch and deadbolt striker with receiver insert Euro-rebate 18 mm	250	32 x 18	20	210810
		latch and deadbolt angled striker plate for electric opener Euro-rebate 18 mm	250	32 x 18	20	210814



9.1.5.3 Striker plates VZ			L	W	H		No
silver	Euro-rebate 18 mm double screw fixing		49	17	9	200	34943
	for hardware groove 7/8/4 - 1 mm gasket-compression		48	16	8	200	34969
	for hardware groove 6/8/4 - 1 mm gasket-compression		48	16	8	200	34979
	Euro-rebate 18 mm angled screw-fixing		48	17	9	200	34980

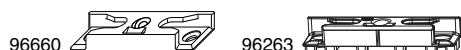

9.1.5.4 Striker plates i.S.			L	W	H		No
silver	Euro-rebate 18 mm angled screw-fixing - 0.7 mm gasket-compression		68	18	9	100	96660
	for hardware groove 6/8/4 - 1 mm gasket-compression		68	18	9	100	96263
	for hardware groove 7/8/4 angled screw-fixing - 1 mm gasket-compression		68	18	9	100	96264



9.1.5.5 Hook and bolt striker plates		L	W	H		No
silver	hook and bolt striker for 4 mm air gap	180	18	8	20	207862 ^{1,2}

¹ Must be used in combination with clip-on end cap 43718!

² Compatible with recess cover cap 358024



9.1.5.6 Latch and deadbolt striker plates		L	W		No
silver	right latch and bolt striker 12mm air gap 9mm offset	180	18	20	218941
	left latch and bolt striker 12mm air gap 9mm offset	180	18	20	218942

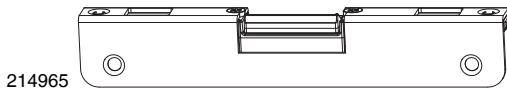

9.1.5.7 Latch and bolt right-angled latch plates		L			No
silver	MF-BO right-angled latch plate with latch element 12mm air gap 9mm offset	190	32 x 18	20	214965



9.1.5.8 Latch striker plates for multi-functional latch		L	W	H		No
silver	latch striker for MF 4mm air gap 9mm offset	120	18	8	20	210501 ¹

¹ Must be used with clip-on end cap 360074!



9.1.5.9 Right-angled latch plates for multi-functional latch		L			No
silver	Right-angled latch plate for MF or latch element Euro-rebate 18 mm	130	32 x 18	20	213325
	right-angled latch plate for MF Euro-rebate 18 mm	130	32 x 18	20	214504



9.1.5.10 Latch striker plates B-TV		L	W	H		No
silver	Euro-rebate 18 mm adjustable	80	17	6,5	50	38924
	for hardware groove 7/8/4 adjustable	80	17	6,5	50	55252
	for hardware groove 6/8/4 adjustable	80	17	6,5	50	94322

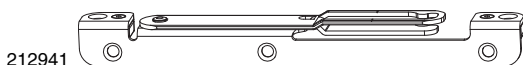

9.1.5.11 Striker plates for door turn-restrictor		L			No
silver	right door turn-restrictor striker 12mm air gap 9mm offset	200	20 x 18	20	212940
	left door turn-restrictor striker 12mm air gap 9mm offset	200	20 x 18	20	212941



9.1.5.12 Shootbolt striker plates for shootbolt protrusion 10 x 5 mm		L	W	H		Nº
silver	deadbolt striker with s slots Euro-rebate	120	18	8	20	55986
	deadbolt striker with s slots for hardware groove 7/8/4	120	18	8	20	50579
	finger bolt striker for hardware groove 7/8/4	84	18	8	20	26617
	finger bolt striker Euro-rebate	84	18	8	20	58667

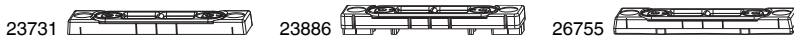

9.1.5.13 Shootbolt striker plates for shootbolt protrusion 8 x 4 mm		L	W	H		Nº
silver	Euro-rebate 18 mm 2 slots H = 6.5 mm	80	17	6,5	100	23731
	hardware groove 2 slots	80	17	6,5	100	23886
	Euro-rebate 18 mm 2 slots H = 7.5 mm	80	17	7,5	100	26755

9.1.6 Striker plates 12 mm air gap 10 mm offset





9.1.6.1 Latch and deadbolt striker plates			L	W	H		No
silver	right	latch and deadbolt striker Z-TA 12mm air gap 10mm offset	220	20	8	20	219237
	left	latch and deadbolt striker Z-TA 12mm air gap 10mm offset	220	20	8	20	219238
		latch and deadbolt striker for 4 mm air gap	208	20	8	50	29787^{1,2}

¹ Must be used with clip-on end cap 354358!

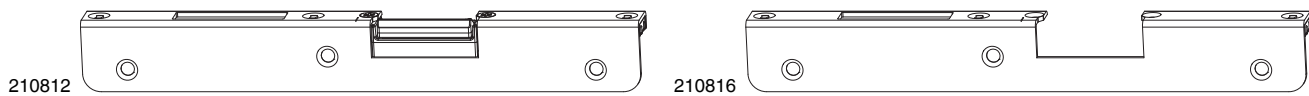
² Compatible with recess cover cap 43524



9.1.6.2 Latch and deadbolt right-angled latch plates			L			No
silver	right	right-angled latch plate for latch and deadbolt striker with receiver insert Euro-rebate 20 mm	250	32 x 20	20	210811
		latch and deadbolt angled striker plate for electric opener Euro-rebate 20 mm	250	32 x 20	20	210815
	left	right-angled latch plate for latch and deadbolt striker with receiver insert Euro-rebate 20 mm	250	32 x 20	20	210812
		latch and deadbolt angled striker plate for electric opener Euro-rebate 20 mm	250	32 x 20	20	210816



9.1.6.3 Striker plates VZ

L	W	H		No		
silver	Euro-rebate 20 mm angled screw-fixing	48	19	9	200	34981



9.1.6.4 Striker plates i.S.

L	W	H		No		
silver	Euro-rebate 20 mm angled screw-fixing - 0.7 mm gasket- compression	68	20	9	100	96861
	Euro-rebate 20 mm angled screw-fixing	68	20	9	100	96561



9.1.6.5 Hook and bolt striker plates



L	W	H		No			
silver	right and left	hook and bolt striker for 4 mm air gap	180	20	8	20	207861^{1,2}

¹ Must be used with clip-on end cap 354358!

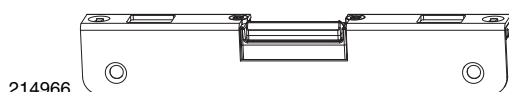
² Compatible with recess cover cap 358024



9.1.6.6 Latch and bolt right-angled latch plates

L			No		
silver	MF-BO right-angled latch plate with latch element 12mm air gap 10mm offset	190	32 x 20	20	214966

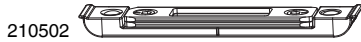

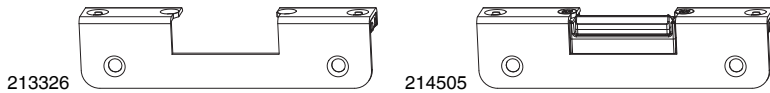

9.1.6.7 Latch striker plates for multi-functional latch		L	W	H		No
silver	latch striker for 4 mm air gap	120	20	8	20	210502 ¹

¹ Must be used with clip-on end cap 354358!

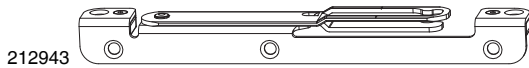

9.1.6.8 Right-angled latch plates for multi-functional latch		L			No
silver	latch striker for MF for electric opener Euro-rebate 20 mm	130	32 x 20	20	213326
	latch striker for MF with latch-receiver insert Euro-rebate 20 mm	130	32 x 20	20	214505



9.1.6.9 Striker plates for door turn-restrictor		L			No
silver	right door turn-restrictor striker 12mm air gap 10mm offset	200	20 x 20	20	212942
	left door turn-restrictor striker 12mm air gap 10mm offset	200	20 x 20	20	212943

9.1.7 Striker plates 12 mm air gap 13 offset

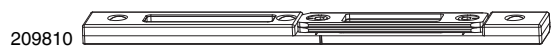

9.1.7.1 Latch and deadbolt striker plates			L	W	H		No
silver	right	latch and deadbolt striker 24mm rebate depth, 13mm offset	208	23	9	50	209809 ¹
	left	latch and deadbolt striker 24mm rebate depth, 13mm offset	208	23	9	50	209810 ¹

¹ Compatible with recess cover cap 43524

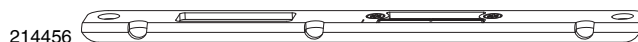
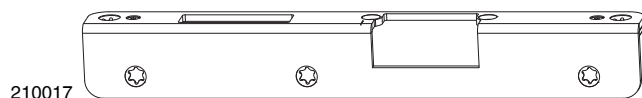

9.1.7.2 Latch and deadbolt right-angled latch plates			L			No
silver	right	right-angled latch plate for latch and deadbolt striker Z-TA 4mm air gap 13mm offset	250	8 x 30	20	226810
		latch and deadbolt angled striker plate for electric opener for 12mm air gap, 13mm offset	250	33 x 24	20	210016
		latch and deadbolt right-angled latch plate 4mm air gap 13mm offset	250	8 x 24	20	214455 ^{1,2}
		right-angled latch plate for latch and deadbolt striker Z-TA for timber	250	8 x 24	20	218901 ^{1,2}
left	right-angled latch plate for latch and deadbolt striker Z-TA 4mm air gap 13mm offset	right-angled latch plate for latch and deadbolt striker Z-TA 4mm air gap 13mm offset	250	8 x 30	5	226811
		latch and deadbolt angled striker plate for electric opener for 12mm air gap, 13mm offset	250	33 x 24	20	210017
		latch and deadbolt right-angled latch plate 4mm air gap 13mm offset	250	8 x 24	20	214456 ^{1,2}
		right-angled latch plate for latch and deadbolt striker Z-TA for timber	250	8 x 24	20	218902 ^{1,2}

¹ Must be used with clip-on end cap 362920!

² Compatible with recess cover cap 360397



9.1.7.3 Striker plates VZ			L	W	H		No
silver	24mm rebate depth, 13mm offset angled screw-fixing		48	23	9	200	34934



9.1.7.4 Striker plates i.S.			L	W	H		No
silver	24mm rebate depth, 13mm offset without reinforcement rings angled screw-fixing		68	23	9	100	364952
	24mm rebate depth, 13mm offset without reinforcement rings angled screw-fixing - 1 mm gasket-compression		68	23	9	100	364953



9.1.7.5 Hook and bolt striker plates			L	W	H		No
hook and bolt striker for 12mm air gap, 13mm offset			180	23	8	20	210779 ¹

¹ Compatible with recess cover cap 358024

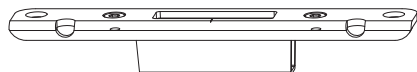

214459

9.1.7.6 Hook and bolt right-angled latch plates

		L	a	b		No
silver	MF-HO striker 4mm air gap 13mm offset	180	8 x 30	5		227065
	hook and bolt striker 4mm air gap 13mm offset	180	8 x 24	20		214459 ¹

¹ Must be used with clip-on end cap 362920!



214457

9.1.7.7 Latch and deadbolt right-angled latch plates

		L	a	b		No
silver	MF-BO right-angled latch plate with latch element 4mm air gap 13mm offset	250	8 x 24	20		214457 ^{1,2,3}

¹ Compatible with recess cover cap 363959

² Must be used with clip-on end cap 362920!

³ Compatible with recess cover cap 364326



211598

9.1.7.8 Latch striker plates for multi-functional latch

		L	W	H		No
silver	latch striker for MF timber 24mm rebate depth 12mm air gap 13mm offset	180	23	8	20	211598



214458

9.1.7.9 Right-angled latch plates for multi-functional latch

		L	a	b		No
silver	right-angled latch plate for MF 4mm air gap 13mm offset	130	8 x 24	20		214458 ¹

¹ Compatible with clip-on end cap 362920 for 12mm air gap.



209347

9.1.7.10 Latch striker plates B-TV

		L	W	H		No
silver	24mm rebate depth, 13mm offset adjustable	80	23	6,5	50	209347

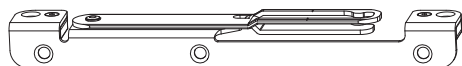

216866

9.1.7.11 Striker plates for door turn-restrictor

		L	a	b		No
silver	right door turn-restrictor striker 12mm air gap 13mm offset	200	20 x 24	20		216865
	left door turn-restrictor striker 12mm air gap 13mm offset	200	20 x 24	20		216866



210782



210781

9.1.7.12 Shootbolt striker plates for shootbolt protrusion 10 x 5 mm

		L	W	H		No
silver	deadbolt striker with s slots for 12mm air gap, 13mm offset	180	23	8	20	210782
	finger bolt striker 24mm rebate depth, 13mm offset	180	23	8	20	210781

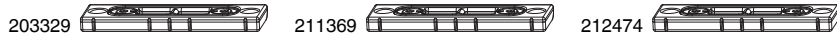

9.1.7.13 Shootbolt striker plates for shootbolt protrusion 8 x 4 mm		L	W	H		N ^o
silver	24mm rebate depth, 13mm offset 2 slots	80	23	6,5	100	203329
	24mm rebate depth, 13mm offset 2 slots with angled screw-fixing + 1 mm gasket-compression	80	23	6,5	100	211369
	24mm rebate depth, 13mm offset 2 slots with angled screw-fixing	80	23	7,7	100	212474

9.2 Striker plates opposite hardware groove



9.2.1 Latch and deadbolt striker plates			L	W	H		N ^o
silver	right	latch and deadbolt striker Z-TA for PVC	235	24	8	20	226489
		latch and deadbolt striker EH for electric opener for PVC	250	32	8	20	209104
		latch and deadbolt striker Z-TA for PVC	250	32	8	20	219258
	left	latch and deadbolt striker Z-TA for PVC	235	24	8	20	226490
		latch and deadbolt striker EH for electric opener for PVC	250	32	8	20	209105
		latch and deadbolt striker Z-TA for PVC	250	32	8	20	219259



9.2.2 Striker plates VZ			L	W	H		N ^o
silver	opposite Eurogroove - 1 mm gasket-compression		48	19	8	200	34606
	opposite Eurogroove		48	17	8	200	34610



9.2.3 Striker plates i.S.			L	W	H		N ^o
silver	right	i.S. striker plate for PVC	80	30	8	20	354987
	left	i.S. striker plate for PVC	80	30	8	20	355000
	opposite Eurogroove - 0.8 mm gasket-compression		68	20	9	100	96558



9.2.4 Hook and bolt striker plates			L	W	H		N ^o
silver	hook and bolt striker Eurogroove		180	18	8	20	217676
	MF-HO striker		180	32	6	20	219260



9.2.5 Latch and deadbolt angled striker plates			L	W	H		N ^o
silver	right	latch and bolt striker for PVC	220	32	7	20	215425
	left	latch and bolt striker for PVC	220	32	7	20	215424
	latch and bolt striker MD for electric opener for PVC		200	24		20	103413



9.2.6 Latch striker plates			L	W		N ^o
silver	latch striker MD with insert E opposite Eurogroove		120	24	20	215497



35250



9.2.7 Latch striker plates B-TV

silver

for Eurogroove

L

W

H



N_o

80

17

6,5

50

35250

9.3 Single piece door striker for timber



9.3.1 Single piece door striker for timber U-6x24x6 13 mm offset



No

24mm rebate depth, 13mm offset silver									
24mm rebate depth, 13mm offset silver	right	2HO-BO	6	24	6	2.200	5	214190 ¹	
		2HO-BO+ZS	6	24	6	2.200	5	216637 ¹	
		2MF+2i.S.	6	24	6	2.400	5	102842 ¹	
		2MF+2i.S. K+500	6	24	6	2.000	5	102846 ¹	
		2MF+3i.S.	6	24	6	2.400	5	102844 ¹	
		2MF-BO	6	24	6	2.200	5	215907 ¹	
		2MF-BO K+500	6	24	6	2.035	5	215911 ¹	
		2MF-BO K+980	6	24	6	2.200	5	215909 ¹	
		2MF-HO	6	24	6	2.200	5	218784 ¹	
		2MF-HO K+605	6	24	6	2.035	5	224649 ¹	
	2MF-HO K+980	6	24	6	2.200	5	224651 ¹		
	4HO-BO	6	24	6	2.200	5	226733 ¹		
	4i.S.	6	24	6	2.400	5	102850 ¹		
	left	2HO-BO	6	24	6	2.200	5	214191 ¹	
		2HO-BO+ZS	6	24	6	2.200	5	216638 ¹	
		2MF+2i.S.	6	24	6	2.400	5	102843 ¹	
		2MF+2i.S. K+500	6	24	6	2.000	5	102847 ¹	
		2MF+3i.S.	6	24	6	2.400	5	102845 ¹	
		2MF-BO	6	24	6	2.200	5	215908 ¹	
		2MF-BO K+500	6	24	6	2.035	5	215912 ¹	
2MF-BO K+980		6	24	6	2.200	5	215910 ¹		
2MF-HO		6	24	6	2.200	5	218785 ¹		
2MF-HO K+605		6	24	6	2.035	5	224650 ¹		
2MF-HO K+980	6	24	6	2.200	5	224652 ¹			
4HO-BO	6	24	6	2.200	5	226734 ¹			
4i.S.	6	24	6	2.400	5	102851 ¹			

¹ Compatible with screw cover cap 362704



9.3.2 Single piece door striker for timber U-8x28x8 13 mm offset



№

28 mm rebate depth, 13 mm offset	silver			1	W	2	L		№
		right	2HO-BO	8	28	8	2.220	5	102937
			2HO-BO+TB	8	28	8	2.220	5	103372
			2MF+2i.S.	8	28	8	2.220	5	102964
			2MF+3i.S.	8	28	8	2.320	5	102966
			2MF-BO	8	28	8	2.220	5	102933
			2MF-BO K+500	8	28	8	2.150	5	103571
			2MF-BO K+980	8	28	8	2.320	5	102935
			2MF-HO	8	28	8	2.220	5	104110
			2MF-HO K+605	8	28	8	2.150	5	104106
			2MF-HO K+980	8	28	8	2.420	5	104108
			4HO-BO	8	28	8	2.220	5	102939
		left	2HO-BO	8	28	8	2.220	5	102938
			2HO-BO+TB	8	28	8	2.220	5	103373
			2MF+2i.S.	8	28	8	2.220	5	102965
			2MF+3i.S.	8	28	8	2.320	5	102967
			2MF-BO	8	28	8	2.220	5	102934
			2MF-BO K+500	8	28	8	2.150	5	103572
			2MF-BO K+980	8	28	8	2.320	5	102936
			2MF-HO	8	28	8	2.220	5	104111
			2MF-HO K+605	8	28	8	2.150	5	104107
			2MF-HO K+980	8	28	8	2.420	5	104109
			4HO-BO	8	28	8	2.220	5	102940





9.3.3 Single piece door striker for timber U-8x28x12 13 mm offset



№

28 mm rebate depth, 13 mm offset	silver			1	W	2	L		№
		right	2HO-BO	8	28	12	2.220	5	102984
			2MF+2i.S.	8	28	12	2.220	5	102994
			2MF+3i.S.	8	28	12	2.320	5	102996
			2MF-BO	8	28	12	2.220	5	102990
			2MF-BO K+980	8	28	12	2.320	5	102992
			4HO-BO	8	28	12	2.220	5	102986
		left	2HO-BO	8	28	12	2.220	5	102985
			2MF+2i.S.	8	28	12	2.220	5	102995
			2MF+3i.S.	8	28	12	2.320	5	102997
			2MF-BO	8	28	12	2.220	5	102991
			2MF-BO K+980	8	28	12	2.320	5	102993
			4HO-BO	8	28	12	2.220	5	102987



9.3.4 Single piece door striker for timber U-10x30x10 15 mm offset					W		L		No
timber 30mm rebate depth 15mm offset silver	right	2HO-BO	10	30	10	2.400	5	215715	
		2HO-BO K+980	10	30	10	2.400	5	215719	
		2HO-BO+TB	10	30	10	2.400	5	215721	
		2HO_BO K+605	10	30	10	2.400	5	215717	
		2MF-BO	10	30	10	2.400	5	217036	
		2MF-BO K+500	10	30	10	2.400	5	217038	
		2MF-BO K+980	10	30	10	2.400	5	217040	
		2MF-HO	10	30	10	2.400	5	219527	
		2MF-HO K+605	10	30	10	2.400	5	219529	
		2MF-HO K+980	10	30	10	2.400	5	219531	
	4HO-BO	10	30	10	2.400	5	216690		
	left	2HO-BO	10	30	10	2.400	5	215716	
	2HO-BO K+980	10	30	10	2.400	5	215720		
	2HO_BO K+605	10	30	10	2.400	5	215718		
	2MF-BO	10	30	10	2.400	5	217037		
	2MF-BO K+500	10	30	10	2.400	5	217039		
	2MF-BO K+980	10	30	10	2.400	5	217041		
	2MF-HO	10	30	10	2.400	5	219528		
	2MF-HO K+605	10	30	10	2.400	5	219530		
	2MF-HO K+980	10	30	10	2.400	5	219532		
4HO-BO	10	30	10	2.400	5	216691			



9.4 Striker plates PVC

9.4.1 Striker plates & single-piece door strikers for Z-TA automatic/comfort PT

Profiles	Single piece door striker 2 MF-HO K+980 left							219395		
	Single piece door striker 2 MF-HO K+980 right							219394	219435	
	Single piece door striker 2 MF-HO K+605 left							219397	219436	
	Single piece door striker 2 MF-HO K+605 right							219396	219437	
	Single piece door striker 2 MF-HO + TB left							225052	225048	
	Single piece door striker 2 MF-HO + TB right							225051	225047	
	Single piece door striker 2 MF-HO left							219390	219430	
	Single piece door striker 2 MF-HO right							219389	219429	
	MF-HO striker plate							219393	219433	
	Latch and deadbolt striker plate Z-TA left							219392	219432	
	Latch and deadbolt striker plate Z-TA right							219391	219431	
	Alphacan Class								219431	219435
	Aluplast 2000								219432	219436
	Aluplast 4000/5000/6000								219429	219434
	Opposite Eurogroove								219430	219438
	Brüggmann AD								219429	219435
	Brüggmann AD 20 mm offset								219216	219220
	Deceuninck Zendow								219257	219221
	Gealan S 3000/7000/8000								219256	219221
	Inoutic AD								219255	219221
	Inoutic Prestige								219254	219221
	KBE System 70 AD								219253	219214
	Kömmering Eurofutur/Eurodur								224097	219214
	Kömmering Eurofutur 88+ MD								217947	217945
	Rehau S 730								217948	217946
	Rehau S706 New								219249	217946
	Rehau Tritec								224039	219207
	Rehau Geneco								224040	219208
	Salamander 2D/3D								217924	-
	Salamander bluEvolution								217925	-
	Salamander Streamline								-	-
	Schlüco Corona AS								-	-
	Schlüco CT 70 - AS								219432	219434
Schlüco Si 82								219432	219435	
Trocal Innonova A3								219432	219435	
Trocal Innonova A5								219256	219220	
Trocal Innonova Comfort								219255	219221	
Trocal Innonova 2000 MD								219255	219221	
Trocal 88+ MD								224800	224799	
Veka Softline/Topline with Eurogroove								213190	224798	
Veka Softline/Topline without Eurogroove								224801	224799	
Veka Softline/Topline without Eurogroove 44 mm width								217937	217938	
Veka Softline/Topline without Eurogroove 44 mm width gasket compression -1 mm								219500	224087	
Veka opposite Eurogroove 15 mm offset								226075	226065	
Wymar Profex 3000								226094	226084	
								227387	226085	
								219361	219364	



9.4.4 Single piece door strikers for Z-TF PT

Profiles	210911	210912	210726	210728	210730	210732	210913	210728	207831	210740	228292	210740	210744	210734	210738	210734	210734	210744	213923	210736	213359	210738	210738	213603	210726	210726	210740	210742	210742	213949	213937	210732	210915	210917	210918		
Z-TF 2 MF-BO K+980 Single piece door striker left	216329	-	-	-	-	-	-	-	-	-	-	-	-	-	-	-	-	-	-	-	-	-	-	-	-	-	-	-	-	-	-	-	-	-	-	216329	
Z-TF 2 MF-BO K+980 Single piece door striker right	216328	-	-	-	-	-	-	-	-	-	-	-	-	-	-	-	-	-	-	-	-	-	-	-	-	-	-	-	-	-	-	-	-	-	-	216328	
Z-TF 2 MF-BO K+605 Single piece door striker left	216327	-	-	-	-	-	-	-	-	-	-	-	-	-	-	-	-	-	-	-	-	-	-	-	-	-	-	-	-	-	-	-	-	-	216327		
Z-TF 2 MF-BO K+605 Single piece door striker right	216326	-	-	-	-	-	-	-	-	-	-	-	-	-	-	-	-	-	-	-	-	-	-	-	-	-	-	-	-	-	-	-	-	-	216326		
Z-TF 2 MF-BO Single piece door striker left	216325	-	-	-	-	-	-	-	-	-	-	-	-	-	-	-	-	-	-	-	-	-	-	-	-	-	-	-	-	-	-	-	-	-	216325		
Z-TF 2 MF-BO Single piece door striker right	216324	-	-	-	-	-	-	-	-	-	-	-	-	-	-	-	-	-	-	-	-	-	-	-	-	-	-	-	-	-	-	-	-	-	216324		
Z-TF 2 MF + 4 i.S. K+500 Single piece door striker left	-	-	213707	212813	213392	213690	213407	212813	213384	213739	-	-	-	-	-	-	-	-	-	-	-	-	-	-	-	-	-	-	-	-	-	-	-	-	-	213707	
Z-TF 2 MF + 4 i.S. K+500 Single piece door striker right	-	-	213706	212812	213391	213689	213406	212812	213383	213738	-	-	-	-	-	-	-	-	-	-	-	-	-	-	-	-	-	-	-	-	-	-	-	-	-	-	213706
Z-TF 2 MF + 4 i.S. striker plates left	-	-	213705	212811	213390	213688	213405	212811	213382	213737	-	-	-	-	-	-	-	-	-	-	-	-	-	-	-	-	-	-	-	-	-	-	-	-	-	213705	
Z-TF 2 MF + 4 i.S. Single piece door striker right	-	-	213704	212810	213389	213687	213404	212810	213381	213736	-	-	-	-	-	-	-	-	-	-	-	-	-	-	-	-	-	-	-	-	-	-	-	-	-	213704	
Z-TF 2 MF + 3 i.S. K+1030 Single piece door striker left	-	-	213703	212809	213388	213686	213403	212809	213380	213735	-	-	-	-	-	-	-	-	-	-	-	-	-	-	-	-	-	-	-	-	-	-	-	-	-	213703	
Z-TF 2 MF + 3 i.S. K+1030 Single piece door striker right	-	-	213702	212808	213387	213685	213402	212808	213379	213734	-	-	-	-	-	-	-	-	-	-	-	-	-	-	-	-	-	-	-	-	-	-	-	-	-	213702	
Z-TF 2 MF + 2 i.S. K+500 Single piece door striker left	-	-	213981	212807	213386	213684	213401	212807	213377	213733	-	-	-	-	-	-	-	-	-	-	-	-	-	-	-	-	-	-	-	-	-	-	-	-	-	213981	
Z-TF 2 MF + 2 i.S. K+500 Single piece door striker right	-	-	213980	212806	213385	213683	213400	212806	213377	213732	-	-	-	-	-	-	-	-	-	-	-	-	-	-	-	-	-	-	-	-	-	-	-	-	-	213980	
Z-TF 2 MF + 2 i.S. Single piece door striker left	210912	213977	210727	210729	210731	210733	210914	210729	207830	210741	228293	210741	210744	210734	210738	210734	210734	210744	213924	210737	213360	210739	210739	213604	210726	210726	210740	210742	210742	213950	213938	210733	210916	210918	-	210912	
Z-TF 2 MF + 2 i.S. Single piece door striker right	210911	213976	210726	210728	210730	210732	210913	210728	207831	210740	228292	210740	210744	210734	210738	210734	210734	210744	213923	210736	213359	210738	210738	213603	210726	210726	210740	210742	210742	213949	213937	210732	210915	210917	-	210911	

9.5 Striker plates ALU

9.5.1 Striker plates ALU 3 mm

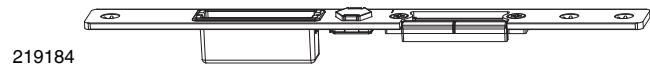
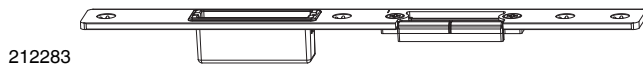

9.5.1.1 Latch and deadbolt striker plates

			L	W	H		No
silver	right	latch and deadbolt striker for alu	250	24	3	20	212282
		latch and deadbolt striker Z-TA for alu	250	24	3	20	219183
	left	latch and deadbolt striker for alu	250	24	3	20	212283
		latch and deadbolt striker Z-TA for alu	250	24	3	20	219184

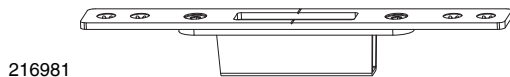
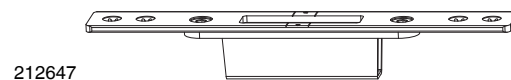
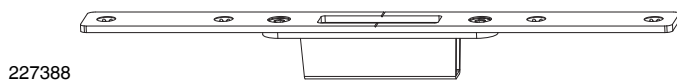

9.5.1.2 Hook- and bolt striker plates

			L	W	H		No
silver	hook and bolt striker for alu		265	24	3	20	227388
			190	25	3	20	212647
				24	3	20	216981

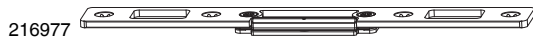

9.5.1.3 Latch and deadbolt striker plates

			L	W	H		No
silver	latch and bolt striker for alu		200	24	3	20	216977

9.5.2 Single piece door striker ALU 6 mm

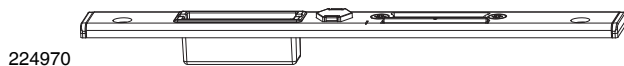

9.5.2.1 Latch and deadbolt striker plates

			L	W	H		No
silver	right	latch and deadbolt striker for PVC	235	24	6	20	213237
		latch and deadbolt striker EH for electric opener for PVC	235	24	6	20	213240
		latch and deadbolt striker Z-TA for alu	240	24	6	20	224969
	left	latch and deadbolt striker for PVC	235	24	6	20	213239
		latch and deadbolt striker EH for electric opener for PVC	235	24	6	20	213241
		latch and deadbolt striker Z-TA for alu	240	24	6	20	224970

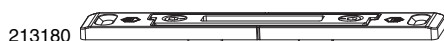

9.5.2.2 Hook- and bolt striker plates

			L	W	H		No
silver	hook and bolt striker for PVC		160	24	6	20	213180

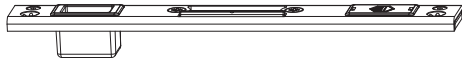

102998

9.5.2.3 Latch and deadbolt striker plates			L	W		N ^o
silver		latch and bolt striker for electric opener for PVC	200	24	20	102998



216755

9.5.2.4 Striker plates for door turn-restrictor			W	L		N ^o
silver	right	door turn-restrictor striker for alu	24	220	20	216754
	left	door turn-restrictor striker for alu	24	220	20	216755

9.6 Single piece door striker for PVC





9.6.1 Single piece door striker ALU 3 mm

			L	W	H		N ^o
silver	right	single piece door striker for alu	1.942	24	3	5	215235
			1.567	24	3	5	215233
			1.692	24	3	5	215231
			1.555	24	3	5	215227
			1.680	24	3	5	214466
			1.930	24	3	5	215229
			1.555	24	3	5	219040
			1.930	24	3	5	219042
			1.680	24	3	5	219038
	left	single piece door striker for alu	1.942	24	3	5	215236
			1.555	24	3	5	215228
			1.692	24	3	5	215232
			1.680	24	3	5	214467
			1.567	24	3	5	215234
			1.930	24	3	5	215230
			1.555	24	3	5	219041
			1.930	24	3	5	219043
			1.680	24	3	5	219039



9.6.2 Single piece door striker ALU 6 mm

				W		L		N ^o
silver	right	2MF-HO	6	24	6	1.855	5	224971
		2MF-HO K+605	6	24	6	1.725	5	224973
		2MF-HO K+980	6	24	6	2.105	5	224975
		4HO-BO	6	24	6	1.850	5	208470
	left	2MF-HO	6	24	6	1.855	5	224972
		2MF-HO K+605	6	24	6	1.725	5	224974
		2MF-HO K+980	6	24	6	2.105	5	224976
		4HO-BO	6	24	6	1.850	5	208471

MACO
PROTECT



Striker plates



10 French casement drive gear

10.1	French casement drive gear	176
10.1.1	French casement drive gears for timber 13 mm offset 24 mm rebate depth U-8x24x8	176
10.1.2	French casement drive gears for timber 13 mm offset 28 mm rebate depth U-8x24x8	176
10.1.3	French casement drive gears 13 mm offset U-8x28x12 opposite Eurogroove	177
10.2	End pieces for french casement drive gears	178
10.2.1	End pieces for timber 13 mm offset 24 mm rebate depth U-8x24x8	178
10.2.2	End pieces for timber 13 mm offset 28 mm rebate depth U-8x28x8	178
10.2.3	End pieces 13mm offset U-8x28x8 opposite Eurogroove	178
10.2.4	End pieces for timber 24 mm rebate depth with integrated MF-HO/HO-BO striker plate U-8x24x8	178
10.2.5	End pieces for timber 28 mm rebate depth with integrated MF-HO/HO-BO striker plate U-8x28x8	179
10.2.6	End pieces with integrated MF-HO/HO-BO striker plate U-8x28x8 for opposite Eurogroove	179
10.3	Extensions for French casement drive gears	180
10.3.1	Extensions 13 mm offset with integrated MF-HO/HO-BO striker plates U-8x24x8	180
10.3.2	Extensions 13 mm offset with integrated MF-HO/HO-BO striker plates U-8x28x8	180
10.3.3	Extensions 13 mm offset U-8x28x8 opposite Eurogroove	180

10 French casement drive gear

10.1 French casement drive gear

219798

10.1.1 French casement drive gears for timber 13 mm offset 24 mm rebate depth U-8x24x8

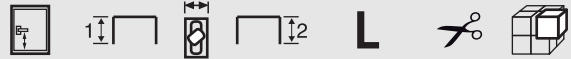

No

silver										
	right	2MF-BO	1.050	8	24	8	2.255	340	5	219423
		2MF-BO K+500	1.050	8	24	8	2.130	340	5	219425
		2MF-BO K+980	1.050	8	24	8	2.400	185	5	219427
		2MF-HO	1.050	8	24	8	2.255	340	5	219798
		2MF-HO K+605	1.050	8	24	8	2.130	340	5	219800
		2MF-HO K+980	1.050	8	24	8	2.400	185	5	219802
	left	2MF-BO	1.050	8	24	8	2.255	340	5	219424
		2MF-BO K+500	1.050	8	24	8	2.130	340	5	219426
		2MF-BO K+980	1.050	8	24	8	2.400	185	5	219428
		2MF-HO	1.050	8	24	8	2.255	340	5	219799
		2MF-HO K+605	1.050	8	24	8	2.130	340	5	219801
		2MF-HO K+980	1.050	8	24	8	2.400	185	5	219803

219032

10.1.2 French casement drive gears for timber 13 mm offset 28 mm rebate depth U-8x24x8

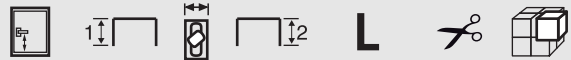







No

silver										
	right	2MF+2i.S.	1.050	8	28	8	2.255	340	5	212413
		2MF+3i.S.	1.050	8	28	8	2.400	185	5	212415
		2MF-BO	1.050	8	28	8	2.255	340	5	214208
		2MF-BO K+500	1.050	8	28	8	2.130	340	5	217144
		2MF-BO K+980	1.050	8	28	8	2.400	185	5	214210
		2MF-HO	1.050	8	28	8	2.255	340	5	219032
		2MF-HO K+605	1.050	8	28	8	2.130	340	5	219591
		2MF-HO K+980	1.050	8	28	8	2.400	185	5	219593
		4HO-BO	1.050	8	28	8	2.255	340	5	212411
	left	2MF+2i.S.	1.050	8	28	8	2.255	340	5	212414
		2MF+3i.S.	1.050	8	28	8	2.400	185	5	212416
		2MF-BO	1.050	8	28	8	2.255	340	5	214209
		2MF-BO K+500	1.050	8	28	8	2.130	340	5	217145
		2MF-BO K+980	1.050	8	28	8	2.400	185	5	214211
		2MF-HO	1.050	8	28	8	2.255	340	5	219033
		2MF-HO K+605	1.050	8	28	8	2.130	340	5	219592
		2MF-HO K+980	1.050	8	28	8	2.400	185	5	219594
		4HO-BO	1.050	8	28	8	2.255	340	5	212412



219030 

10.1.3 French casement drive gears 13 mm offset U-8x28x12 opposite Eurogroove							L			No
silver	right	2MF-BO	1.050	8	28	8	2.255	340	5	214216
		2MF-BO K+500	1.050	8	28	12	2.130	340	5	217154
		2MF-BO K+980	1.050	8	28	8	2.400	185	5	214218
		2MF-HO	1.050	8	28	8	2.255	340	5	219030
		2MF-HO K+605	1.050	8	28	8	2.130	340	5	219586
		2MF-HO K+980	1.050	8	28	8	2.400	185	5	219589
	left	4HO-BO	1.050	8	28	8	2.255	340	5	213117
		2MF-BO	1.050	8	28	8	2.255	340	5	214217
		2MF-BO K+500	1.050	8	28	12	2.130	340	5	217155
		2MF-BO K+980	1.050	8	28	8	2.400	185	5	214219
		2MF-HO	1.050	8	28	8	2.255	340	5	219031
		2MF-HO K+605	1.050	8	28	8	2.130	340	5	219588
		2MF-HO K+980	1.050	8	28	8	2.400	185	5	219590
		4HO-BO	1.050	8	28	8	2.255	340	5	213118

10.2 End pieces for french casement drive gears



10.2.1 End pieces for timber 13 mm offset 24 mm rebate depth U-8x24x8

						L		No
silver	left/right	12mm air gap 13mm offset	8	24	8	125	5	219444
						260	5	219445
						415	5	219446



10.2.2 End pieces for timber 13 mm offset 28 mm rebate depth U-8x28x8

						L		No
silver	right	for timber 12mm air gap	8	28	8	125	5	215858
	left	for timber 12mm air gap	8	28	8	125	5	215859
	right	for timber 12mm air gap	8	28	8	260	5	212419
	left	for timber 12mm air gap	8	28	8	260	5	212420
	right	for timber 12mm air gap	8	28	8	415	5	212421
	left	for timber 12mm air gap	8	28	8	415	5	212422

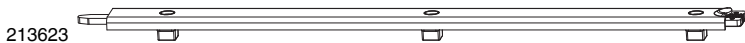

10.2.3 End pieces 13mm offset U-8x28x8 opposite Eurogroove

						L		No
silver	right	for Eurogroove	8	28	8	125	5	215862
	left	for Eurogroove	8	28	8	125	5	215863
	right	for Eurogroove	8	28	8	260	5	213621
	left	for Eurogroove	8	28	8	260	5	213622
	right	for Eurogroove	8	28	8	415	5	213623
	left	for Eurogroove	8	28	8	415	5	213624



10.2.4 End pieces for timber 24 mm rebate depth with integrated MF-HO/HO-BO striker plate U-8x24x8

						L		No
silver	right	12mm air gap 13mm offset	8	24	8	355	5	219438
	left	12mm air gap 13mm offset	8	24	8	355	5	219439
	right	12mm air gap 13mm offset	8	24	8	565	5	219440
	left	12mm air gap 13mm offset	8	24	8	565	5	219441

216254

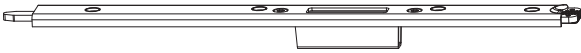

216256

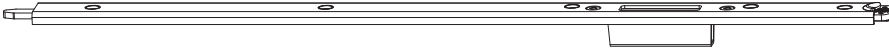

10.2.5 End pieces for timber 28 mm rebate depth with integrated MF-HO/HO-BO striker plate U-8x28x8



silver								
	right	8	28	8	355	5	216254	
	left	8	28	8	355	5	216255	
	right	8	28	8	565	5	216256	
	left	8	28	8	565	5	216257	

216294

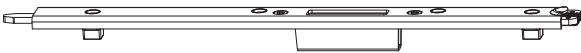

216296

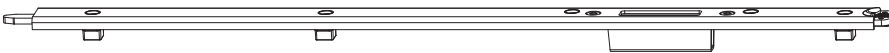

10.2.6 End pieces with integrated MF-HO/HO-BO striker plate U-8x28x8 for opposite Eurogroove



silver								
	right	opposite Eurogroove	8	28	8	355	5	216294
	left	opposite Eurogroove	8	28	8	355	5	216295
	right	opposite Eurogroove	8	28	8	565	5	216296
	left	opposite Eurogroove	8	28	8	565	5	216297

10.3 Extensions for French casement drive gears



219442

10.3.1 Extensions 13 mm offset with integrated MF-HO/HO-BO striker plates U-8x24x8



L



No

silver	right	12mm air gap 13mm offset	8	24	8	590	5	219442
	left	12mm air gap 13mm offset	8	24	8	590	5	219443



216258

10.3.2 Extensions 13 mm offset with integrated MF-HO/HO-BO striker plates U-8x28x8



L



No

silver	right	timber 12 mm air gap 28 mm rebate depth	8	28	8	590	5	216258
	left	timber 12 mm air gap 28 mm rebate depth	8	28	8	590	5	216259

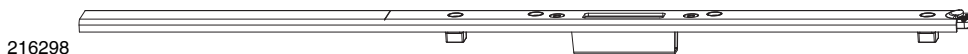

216298

10.3.3 Extensions 13 mm offset U-8x28x8 opposite Eurogroove



L



No

silver	right	opposite Eurogroove	8	28	8	590	5	216298
	left	opposite Eurogroove	8	28	8	590	5	216299



11 Shootbolts





11.1 Finger operated door shootbolts	182
11.1.1 Finger operated door shootbolts	182
11.1.2 Finger operated door shootbolts 12 mm air gap	182
11.1.3 Finger operated door shootbolts for Eurogroove	183
11.1.4 Finger operated door shootbolts for PVC	183
11.2 Finger operated interior door shootbolts	184
11.2.1 Finger operated interior door shootbolts 4 mm air gap	184

11 Shootbolts

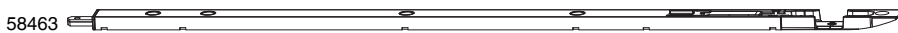
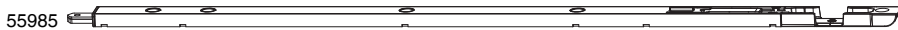

11.1 Finger operated door shootbolts

11.1.1 Finger operated door shootbolts



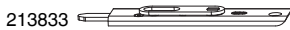



11.1.1.1 Finger operated door shootbolts 4 mm air gap 9 mm offset						L		No
silver	4mm air gap		R8	11	8	255	20	58464
						540	20	58468
				18	8	255	20	208998
						540	20	208999
					10	540	20	55985
						255	20	55989
		bottom left	R8	18	7	255	20	59424
		bottom right	R8	18	7	255	20	59425
			R90	18	8	540	20	58463
						255	20	58467
					10	255	20	59422
						540	20	59423

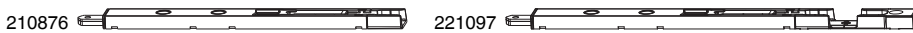

11.1.1.2 Finger operated door shootbolts 4 mm air gap 13 mm offset U-6x24x6						L		No
silver	for 4 mm air gap, 13 mm offset	left		20	10	120	20	213834
		right		20	10	120	20	213833

11.1.2 Finger operated door shootbolts 12 mm air gap



11.1.2.1 Finger operated door shootbolts 12 mm air gap 9 mm offset						L		No
silver	4mm air gap		R8	11	8	255	20	58464¹
						540	20	58468¹
				18	8	255	20	208998¹
						540	20	208999¹
					10	540	20	55985¹
						255	20	55989¹
		Euro-rebate		18	10	200	20	210876
						255	20	221097

¹ Must be used in combination with clip-on end cap 43718!

58608

59427

11.1.2.2 Finger operated door shootbolts 12 mm air gap hardware groove 6/8/4					L		No
silver	Hardware groove 6/8/4	left	11	8	255	20	58609
		right	11	8	540	20	59426
		left			255	20	58608
		right			540	20	59427

59429 58574

11.1.2.3 Finger operated door shootbolts 12 mm air gap hardware groove 7/8/4					L		No
silver	hardware groove 7/8/4	left	11	8	255	20	59428
		right	11	8	540	20	59430
		left			255	20	59429
		right			540	20	59431
		left	18	10	255	20	58575
		right	18	10	255	20	58574

213831

11.1.2.4 Finger operated door shootbolts 12 mm air gap 13 mm offset U-6x24x6					L		No
silver	for 12mm air gap, 13mm offset	right	20	10	120	20	213831
		left	20	10	120	20	213832

11.1.3 Finger operated door shootbolts for Eurogroove

213829

11.1.3.1 Finger operated door shootbolts U-6x24x6					L		No
silver	for Eurogroove MD	left	20	10	120	20	213830
		right	20	10	120	20	213829

213825

11.1.3.2 Finger operated door shootbolts U-6x32x6					L		No
silver	for Eurogroove	right	20	10	130	20	213825
		left	20	10	130	20	213826

208998

11.1.4 Finger operated door shootbolts for PVC					L		No
silver	4mm air gap	R8	11	8	255	20	58464 ¹
				8	540	20	58468 ¹
			18	8	255	20	208998 ¹
				8	540	20	208999 ¹
			10	8	540	20	55985 ¹
				8	255	20	55989 ¹

¹ Must be used together with packer for shootbolt.



11.2 Finger operated interior door shootbolts

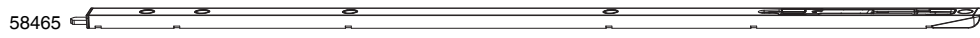

11.2.1 Finger operated interior door shootbolts 4 mm air gap					L		
silver	4mm air gap	R8	12	8	600	20	58465
					540	20	209000
					255	20	57915
					425	20	57916
		R90	12	8	540	20	59433
					255	20	58029
					425	20	58030
					600	20	58469



12 Accessories





12.1	End pieces for door lock Z-TS and G-TS	186
12.1.1	Inline end pieces	186
12.1.2	Reverse-action end pieces	188
12.2	Accessories for door lock Z-TA	190
12.2.1	Extension faceplates	190
12.2.2	Shortening faceplates	190
12.2.3	Intermediate faceplates	190
12.2.4	Motor for Z-TA Comfort	190
12.2.5	Access control systems	190
12.2.6	Access control systems — basic packages	191
12.2.7	Cables and accessories for profiles with 4 mm and 12 mm air gap	192
12.2.8	Test magnet for Z-TA	192
12.2.9	Power supplies — transformers	193
12.3	Accessories for modular locks	194
12.3.1	Faceplate extension	194
12.3.2	Shortening faceplate	194
12.3.3	Connector faceplate	194
12.3.4	Faceplate module with magnetic cam	195
12.3.5	Faceplate module HO-BO	195
12.3.6	Faceplate module additional lock	195
12.3.7	Faceplate module for door restrictor	196
12.4	Accessories for B-TV MULTI TREND	197
12.4.1	End pieces top with i.S. without shootbolt protrusion	197
12.4.2	End pieces top with VZ without shootbolt protrusion	197
12.4.3	End pieces top with i.S. and shootbolt protrusion	197
12.4.4	End pieces top without cam with shootbolt protrusion	197
12.4.5	End pieces top with i.S. and shootbolt protrusion	197
12.4.6	End pieces bottom with i.S. without shootbolt protrusion	197
12.4.7	End pieces bottom with VZ without shootbolt protrusion	197
12.5	Accessories for B-TV MULTI MATIC	198
12.5.1	Faceplate extension B-TV	198
12.5.2	Corner element B-TV	198
12.5.3	End pieces bottom without cam with shootbolt protrusion	198
12.6	Roller latch for Z-TS PT-M	199
12.7	Offset latch for Z-TS PT-M	199
12.8	Offset latch for Z-TF PT-M	199
12.9	Packer for shootbolt	199
12.10	Recess cover cap	199
12.11	Recess cover caps	200
12.12	Cover caps	200
12.13	Faceplate strip covers	200
12.14	Shootboot striker	200
12.15	Universal access key	200
12.16	Turn-only hinge safety device	200
12.17	Latch clips	201
12.18	Latch elements	201

12 Accessories

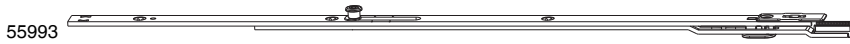
12.1 End pieces for door lock Z-TS and G-TS

12.1.1 Inline end pieces



12.1.1.1 End pieces without shootbolt protrusion						L		No
silver	1.900 - 2.100	16	255	1	300	10	57824	
		20	255	1	300	10	11243	
		24	255	1	300	10	101506	
		24/16	255	1	300	10	212767	
	2.100 - 2.300	16	255	1	500	10	55993	
		20	255	1	500	10	11244	
		24	255	1	500	10	101507	
		24/16	540	1	500	10	215167	
	2.185 - 2.385	16	540	1	585	10	57825	
		20	540	1	585	10	101489	
		24	540	1	585	10	101508	
		24/16	540	1	585	10	215172	
2.300 - 2.500	16	255	1	700	10	57826		
	20	255	1	700	10	101490		
	24	255	1	700	10	101509		
	24/16	255	1	700	10	215169		
2.385 - 2.585	16	540	1	785	10	57827		
	20	540	1	785	10	101491		
	24	540	1	785	10	101510		
	24/16	540	1	785	10	215175		



58329

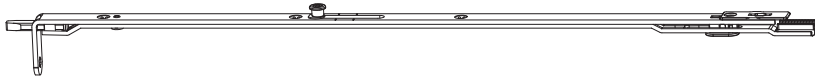

58330

12.1.1.2 End pieces with shootbolt protrusion and lateral fixing tab

					L		No
silver	1.900 - 2.100	16	255	1	300	10	58329
			0	300	10	58331	
		20	255	1	300	10	201160
			0	300	10	201162	
		24	255	1	300	10	101492
			0	300	10	101493	
	2.100 - 2.300	16	255	1	500	10	58330
			0	500	10	59405	
		20	255	1	500	10	201161
			0	500	10	201163	



58107



55992



58458



58333



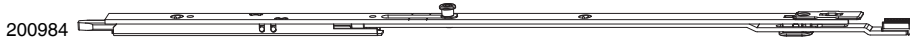

12.1.1.3 End pieces with shootbolt protrusion without lateral fixing tab

					L		No
silver	1.900 - 2.100	16	255	1	300	10	58107
		20	255	1	300	10	101483
		24	255	1	300	10	101500
		24 / 16	255	1	300	5	215154
	2.100 - 2.300	16	255	1	500	10	55992
	2.185 - 2.385	16	540	1	585	10	58458
	2.385 - 2.585	16	540	1	785	10	58333

12.1.2 Reverse-action end pieces



12.1.2.1 Reverse-action end piece with shootbolt protrusion

					L		No
silver	1.900 - 2.100	16	255	1	300	10	200983
		20	255	1	300	10	101484
		24	255	1	300	10	101501
		24 / 16	255	1	300	5	215160
	2.100 - 2.300	16	255	1	500	10	200984
		20	255	1	500	10	101485
		24	255	1	500	10	101502
		24 / 16	255	1	500	5	215164
	2.185 - 2.385	16	540	1	585	10	200985
		20	540	1	585	10	101486
		24	540	1	585	10	101503
		24 / 16	540	1	585	5	215173
2.300 - 2.500	16	255	1	700	10	200986	
	20	255	1	700	10	101487	
	24	255	1	700	10	101504	
	24 / 16	255	1	700	5	215170	
2.385 - 2.585	16	540	1	785	10	200987	
	20	540	1	785	10	101488	
	24	540	1	785	10	101505	
	24 / 16	540	1	785	5	215176	

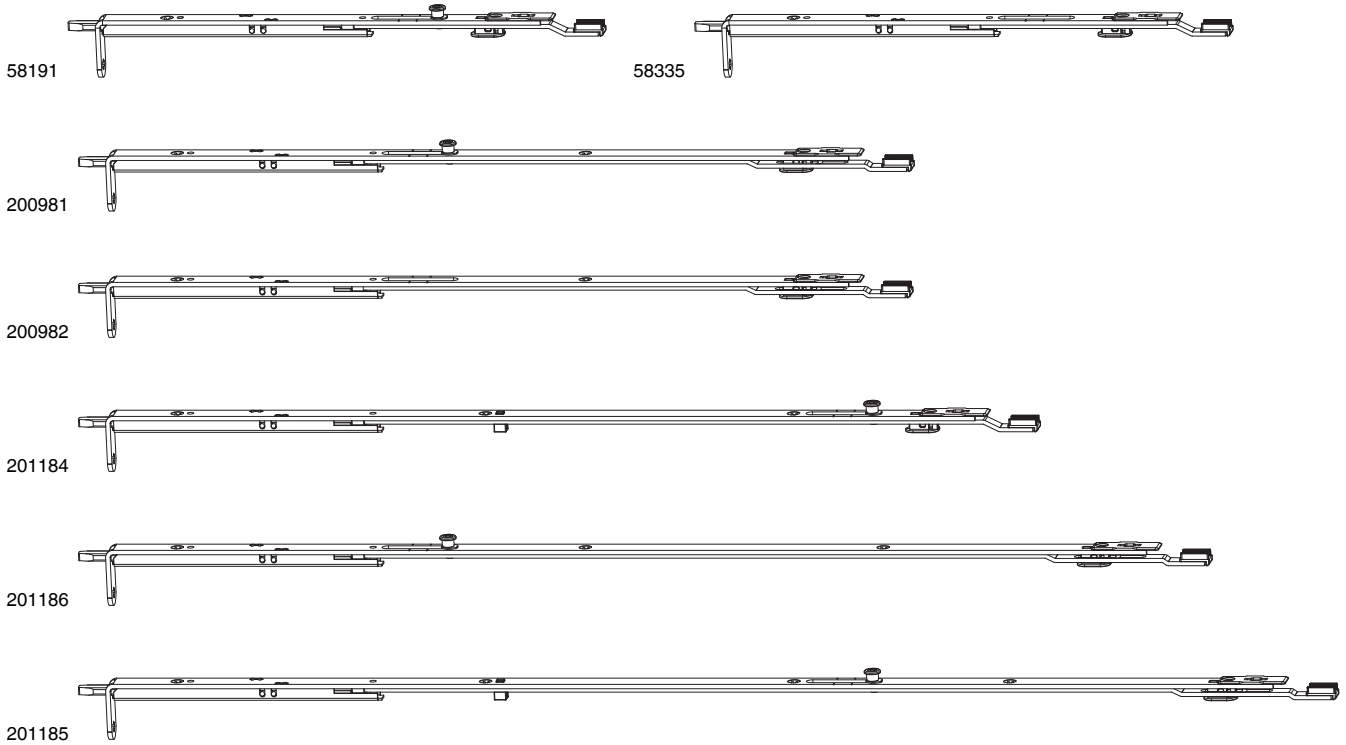

12.1.2.2 Reverse-action end piece with shootbolt protrusion and lateral fixing tab						L		No
silver	1.900 - 2.100	16	255	1	300	10	58191	
				0	300	10	58335	
		20	255	1	300	10	101072	
	2.100 - 2.300			0	300	10	101073	
		24	255	1	300	10	101494	
				0	300	10	101499	
	2.185 - 2.385	16	540	1	585	10	200981	
				0	500	10	200982	
		20	255	1	500	10	101479	
	2.300 - 2.500	24	255	1	500	10	101495	
		16	540	1	585	10	201184	
		20	540	1	585	10	101480	
	2.385 - 2.585	24	540	1	585	10	101496	
		16	255	1	700	10	201186	
		20	255	1	700	10	101481	
	24	255	1	700	10	101497		
	16	540	1	785	10	201185		
	20	540	1	785	10	101482		
		24	540	1	785	10	101498	

12.2 Accessories for door lock Z-TA



12.2.1 Extension faceplates			L		No
Extension faceplate Z-TA silver	F	16	250	10	104785
		20	250	10	104786
		24	250	10	104787
		24/16	250	10	104788
	U	24	250	10	104789



12.2.2 Shortening faceplates			L		No
Shortening faceplate Z-TA silver	F	16	50	10	104790
		20	50	10	104791
		24	50	10	104792
		24/16	50	10	104793
	U	24	50	10	104794

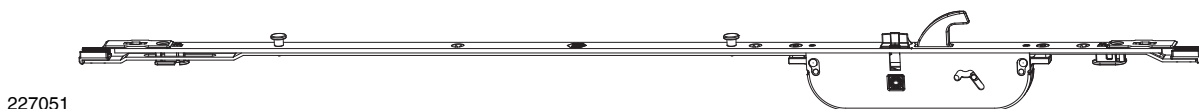

12.2.3 Intermediate faceplates			L		No
intermediate faceplate with 1 MF-HO silver	F	16	705	5	227051
		20	705	5	227052
		24	705	5	227053
		24/16	705	5	227054
	U	24	705	5	227055

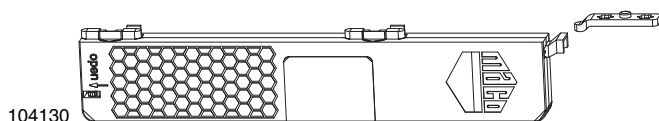

12.2.4 Motor for Z-TA Comfort			No
motor for Z-TA Comfort		1	104130

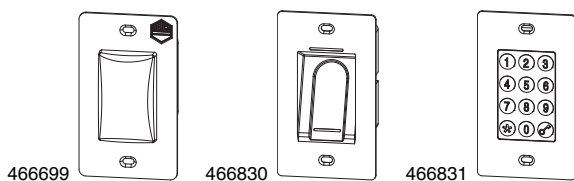

12.2.5 Access control systems			No
openDoor transponder plus		1	466699
OpenDoor touch (fingerprint)		1	466830
OpenDoor code (keypad)		1	466831

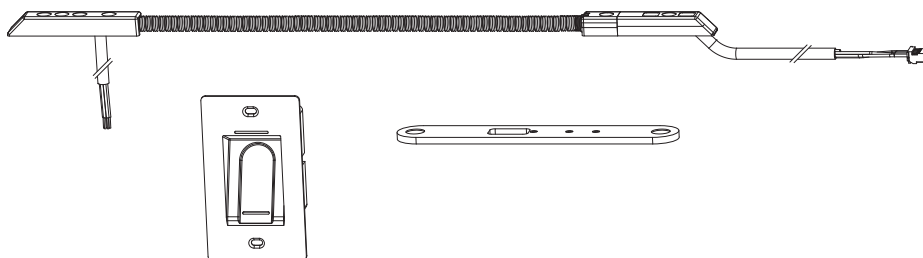

104145

12.2.6 Access control systems — basic packages



No

openDoor touch set F16	1	104145¹
openDoor touch set F20	1	104144²
openDoor transponder plus set for timber 4mm air gap F16	1	104140³
openDoor code set F20	1	104147
openDoor code set for timber 4mm air gap F16	1	104146³
openDoor touch set for timber 4mm air gap F16	1	104143³
openDoor transponder plus set for 12mm air gap F20	1	104141²
openDoor transponder plus set F16	1	104142¹
openDoor code set F16	1	104148¹
openDoor set silver V3.0	100	458252
openDoor set white V3.0	100	458253

¹ Set with access control, clip-on cable transition 2,5/6 m, and 2x cover plate F-16

² Set with access control, clip-on cable transition 2,5/6 m, and 2x cover plate F-20

³ Set with access control, clip-on cable transition 2,5/6 m, cable tray for 4 mm air gap and cover plate F-16



466842

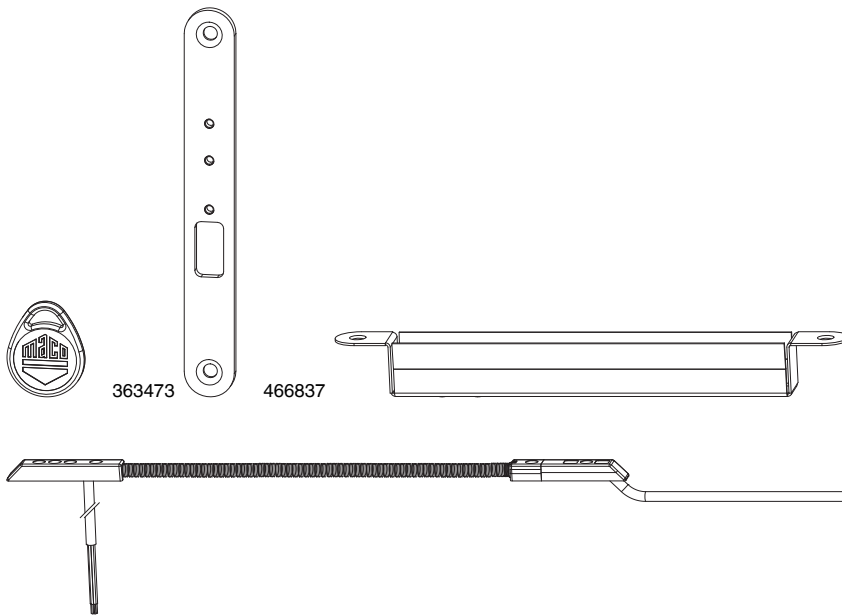

458274

363473

466837

466833

12.2.7 Cables and accessories for profiles with 4 mm and 12 mm air gap



No

OpenDoor tester	1	466842
Transponder 125 kHz for openDoor	1	458274
cable 10 m	1	466835
cable junction cover plate, timber stainless steel	1	363473
cable tray for 4 mm air gap	1	466837
clip-on cable transition 2.5 / 10m	1	466834
clip-on cable transition 2.5 / 6m	1	466833
cover for cable transition F-20	1	466838
pigtail cable 150mm	1	466836

227538



12.2.8 Test magnet for Z-TA



No

test magnet Z-TA	20	227538
------------------	----	--------



367702

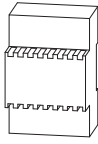

367701

12.2.9 Power supplies — transformers



No

Power supply flush-mounted

1

367702

Power supply top hat track



1

367701

12.3 Accessories for modular locks



102219 

12.3.1 Faceplate extension

			L		No
extension faceplate silver	F	16	250	10	102219
		20	250	10	102555
		24	250	10	102745
		24/16	250	10	102929
	U	24	250	10	103059

102556 

12.3.2 Shortening faceplate

			L		No
shortening faceplate silver	F	16	50	10	102556
		20	50	10	102557
		24	50	10	103062
		24/16	50	10	102930
	U	24	50	10	103058

215098





215102





212643





12.3.3 Connector faceplate

			L		No
connector with BO silver	F	16	705	5	215098
				5	215102
		20	705	5	215099
				5	215103
		24	705	5	215100
	5			215104	
	24/16	705	5	215101	
			5	215105	
	U	24	705	5	215396
				5	215395
connector with HO-BO silver	F	16	705	5	212643
				5	212758
	20	705	705	5	212762
				5	213961
	U	24	705	5	215376

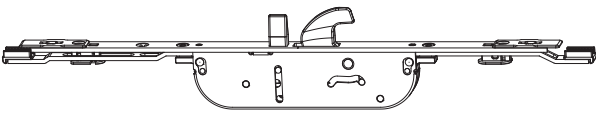

212646 

12.3.4 Faceplate module with magnetic cam			L		Nº
Faceplate module with magnetic cam silver	F	16	350	5	212646
		20	350	5	212761
		24	350	5	212765
		24 /16	350	5	213964
	U	24	350	5	215380

212644 

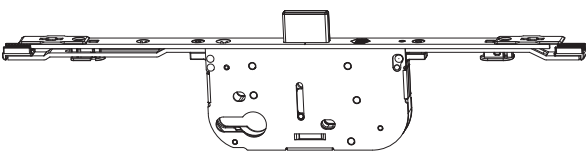
12.3.5 Faceplate module HO-BO			L		Nº
faceplate module with HO-BO silver	F	16	350	5	212644
		20	350	5	212759
		24	350	5	212763
		24 /16	350	5	213962
	U	24	350	5	215377

212776 

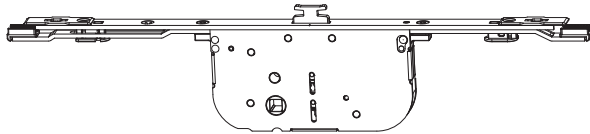

12.3.6 Faceplate module additional lock				L		Nº
faceplate module with ZS silver	F	16	BS 35	350	5	212645
			BS 40	350	5	212773
			BS 45	350	5	212774
			BS 50	350	5	212775
			BS 55	350	5	212776
			BS 65	350	5	212778
	20	BS 35	350	5	212760	
		BS 40	350	5	212889	
		BS 45	350	5	212890	
		BS 50	350	5	212891	
		BS 55	350	5	212892	
		BS 65	350	5	212894	
	24	BS 35	350	5	212764	
		BS 40	350	5	212895	
		BS 45	350	5	212896	
		BS 50	350	5	212897	
		BS 55	350	5	212898	
		BS 65	350	5	212900	
	24 /16	BS 35	350	5	213963	
		BS 40	350	5	213965	
		BS 45	350	5	213966	
		BS 50	350	5	213967	
		BS 55	350	5	213968	
		BS 65	350	5	213969	
U	24	BS 35	350	5	215378	
		BS 45	350	5	215379	



213050

12.3.7 Faceplate module for door restrictor

faceplate module with TB silver

				L		No
F	16	BS 35		350	5	213046
		BS 40		350	5	213047
		BS 45		350	5	213048
		BS 50		350	5	213049
		BS 55		350	5	213050
		BS 65		350	5	213051
	20	BS 35		350	5	213054
		BS 40		350	5	213055
		BS 45		350	5	213056
		BS 50		350	5	213057
		BS 55		350	5	213058
		BS 65		350	5	213059
	24	BS 35		350	5	213062
		BS 40		350	5	213063
		BS 45		350	5	213064
BS 50			350	5	213065	
BS 55			350	5	213066	
BS 65			350	5	213067	
24 /16	BS 35		350	5	214030	
	BS 40		350	5	214031	
	BS 45		350	5	214032	
	BS 50		350	5	214033	
	BS 55		350	5	214034	
	BS 65		350	5	214035	
U	24	BS 35		350	5	215381
		BS 45		350	5	215382

12.4 Accessories for B-TV MULTI TREND

55488

12.4.1 End pieces top with i.S. without shootbolt protrusion				L		No
silver	1.850 - 2.100	16	1	650	10	55488
	2.101 - 2.350	16	1	900	10	55489
	2.351 - 2.600	16	2	1.150	10	55490

55171

12.4.2 End pieces top with VZ without shootbolt protrusion				L		No
silver	1.850 - 2.100	16	1	650	10	55169
	2.101 - 2.350	16	1	900	10	55170
	2.351 - 2.600	16	2	1.150	10	55171

201458

12.4.3 End pieces top with i.S. and shootbolt protrusion				L		No
silver	2.351 - 2.600	16	1	1.150	5	201458

55215

12.4.4 End pieces top without cam with shootbolt protrusion				L		No
silver	1.850 - 2.100	16	1	650	10	55215
	2.101 - 2.350	16	1	900	10	55216

55217

12.4.5 End pieces top with i.S. and shootbolt protrusion				L		No
silver	2.351 - 2.600	16	1	1.150	10	55217

55491

12.4.6 End pieces bottom with i.S. without shootbolt protrusion				L		No
silver	1.850 - 2.600	16	1	400	10	55491



55172

12.4.7 End pieces bottom with VZ without shootbolt protrusion				L		No
silver	1.850 - 2.600	16	1	400	10	55172

12.5 Accessories for B-TV MULTI MATIC

203697 

12.5.1 Faceplate extension B-TV

			L		No
silver	1	1.701 - 1.950	497	10	203697
		1.951 - 2.200	747	10	203698
	2	2.201 - 2.450	997	10	203699

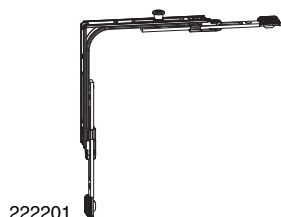





222201

12.5.2 Corner element B-TV

				No	
silver	with 1 i.S.	320 - 1.650	360 - 2.450	50	222201

225092 

12.5.3 End pieces bottom without cam with shootbolt protrusion

				L		No
silver	500 - 2.350	16	170	170	20	225092



203784

12.6 Roller latch for Z-TS PT-M		N ^o
roller latch Z-TS BS 35 PT	10	203784
roller latch Z-TS BS 40 PT	10	203785
roller latch Z-TS BS 45 PT	10	203786
roller latch Z-TS BS 50 PT	10	203787
roller latch Z-TS BS 55 PT	10	203788
roller latch Z-TS BS 60 PT	10	203789
roller latch Z-TS BS 65 PT	10	203790
roller latch Z-TS BS 70 PT	10	203791
roller latch Z-TS BS 80 PT	10	203792

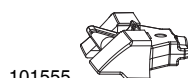

101555

12.7 Offset latch for Z-TS PT-M		N ^o
offset latch Z-TS BS 35 PT	10	101555
offset latch Z-TS BS 40 PT	10	101556
offset latch Z-TS BS 45 PT	10	101553
offset latch Z-TS BS 50 PT	10	101557
offset latch Z-TS BS 55 PT	10	101477
offset latch Z-TS BS 65 PT	10	101558
offset latch Z-TS BS 70 PT	10	101559
offset latch Z-TS BS 80 PT	10	101560

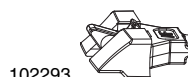

102293

12.8 Offset latch for Z-TF PT-M		N ^o
offset latch MF for Z-TF with 4 mm ribbed washer	10	102293

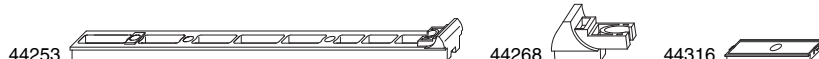

44253

44268

44316

12.9 Packer for shootbolt		N ^o
packer for finger-operated door shootbolt 200mm for Eurogroove	20	360159
packer for shootbolt for Eurogroove silver	50	44253
Clip-On End Cap for Shootbolts	100	44268
Packer for Shootbolts	100	44316
packer for finger-operated door shootbolt right for Eurogroove	50	44372
packer for finger-operated door shootbolt left for Eurogroove	50	44373



43718

362920

360074

354358

44205

44206

12.10 Recess cover cap		N ^o
clip-on end cap for right-angled latch plate timber 30mm rebate depth 13mm offset black	100	369691
Clip-On End Cap for strikers and shootbolts Euro-rebate FT18 9V Silver	100	43718
clip-on end cap for right-angled latch plate 24 x 8 Euro-rebate 12 air gap, 24mm rebate depth black	100	362920
clip-on end cap for latch striker plate Euro-rebate 18mm rebate depth 9mm offset	100	360074
Clip-On End Cap for striker Euro-rebate FT20 9V Silver	100	354358
clip-on end cap for striker plate right hardware groove silver	100	44205
adapter spacer for DL striker hardware groove left silver	100	44206



12.11 Recess cover caps



No

Dust box cover Timber long right and left For timber profiles Black	50	358024
recess cover cap for latch and deadbolt striker black	50	360397
recess cover cap Z-TF latch and bolt striker for electric opener black -30,7x PT	100	364326
recess cover cap for latch and deadbolt striker for timber profiles silver	50	43524

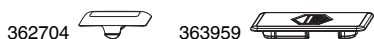

12.12 Cover caps



No

cover for angled screw-fixing black	100	362704
cover cap latch and bolt striker black	100	363959



12.13 Faceplate strip covers



No

extension for single piece door striker, timber U-6/24/6 silver	5	102852
faceplate strip cover silver F-1.400x20 PT	20	364770
faceplate strip cover silver F-1.400x24/16 PT	20	364771
faceplate strip cover silver U-1.000x24	5	103001
faceplate strip cover 1.400 silver	10	94019

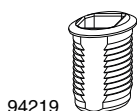

12.14 Shootboot striker



No

drill-in bush for deadbolt 8x4 silver	100	94219
---------------------------------------	-----	--------------



12.15 Universal access key



No

universal access key	20	40720
----------------------	----	--------------

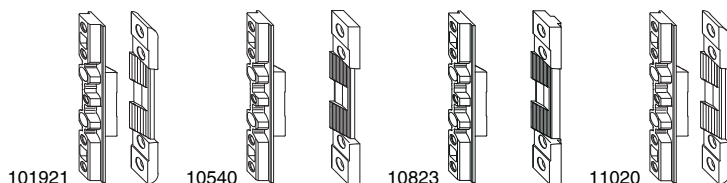

12.16 Turn-only hinge safety device



No

turn-only hinge safety device for 4 mm air gap, 13 mm offset silver	20	101921
turn-only hinge safety device Euro-rebate 18 mm silver	20	10540
turn-only hinge safety device hardware groove silver	20	10823
turn-only hinge safety device for 4 mm air gap silver	20	11020



43586 

12.17 Latch clips		No
latch clips	50	43586
latch clip for offset latch	50	362906

369143 

12.18 Latch elements		No
Upper part latch element for PVC gasket compression -2 mm silver	50	369143

**MACO
PROTECT**



Accessories



13 Jigs

13.1	Striker plate jigs	204
13.1.1	Drilling jig for main lock case	204
13.2	Air gap jigs for Z-TA	204

13 Jigs

13.1 Striker plate jigs

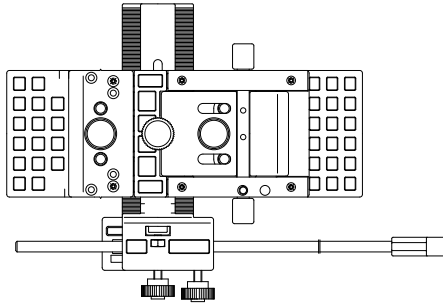

28603

13.1.1 Drilling jig for main lock case



Nº

drill jig for lock case

1

28603

13.2 Air gap jigs for Z-TA

Nº

PVC rebate gap 20 mm sash overlap

757154

PVC rebate gap 21 mm sash overlap

757155

Timber 12 mm rebate gap 20 mm overlap

757156

Timber 12 mm rebate gap 18 mm overlap

757157



Timber 4 mm rebate gap 15 mm overlap



757159

Timber 4 mm rebate gap 18 mm overlap



757158





№		Page	№		Page	№		Page
213048	5	196	215229	5	173	219041	5	173
213049	5	196	215230	5	173	219042	5	173
213050	5	196	215231	5	173	219043	5	173
213051	5	196	215232	5	173	219183	20	171
213054	5	196	215233	5	173	219184	20	171
213055	5	196	215234	5	173	219231	20	146
213056	5	196	215235	5	173	219232	20	146
213057	5	196	215236	5	173	219233	20	154
213058	5	196	215376	5	194	219234	20	154
213059	5	196	215377	5	195	219235	20	149
213062	5	196	215378	5	195	219236	20	149
213063	5	196	215379	5	195	219237	20	157
213064	5	196	215380	5	195	219238	20	157
213065	5	196	215381	5	196	219258	20	162
213066	5	196	215382	5	196	219259	20	162
213067	5	196	215395	5	194	219260	20	162
213117	5	177	215396	5	194	219376	20	153
213118	5	177	215424	20	162	219378	20	153
213180	20	171	215425	20	162	219423	5	176
213237	20	171	215497	20	162	219424	5	176
213239	20	171	215683	20	153	219425	5	176
213240	20	171	215684	20	153	219426	5	176
213241	20	171	215685	20	153	219427	5	176
213325	20	155	215715	5	166	219428	5	176
213326	20	158	215716	5	166	219438	5	178
213621	5	178	215717	5	166	219439	5	178
213622	5	178	215718	5	166	219440	5	178
213623	5	178	215719	5	166	219441	5	178
213624	5	178	215720	5	166	219442	5	180
213825	20	183	215721	5	166	219443	5	180
213826	20	183	215858	5	178	219444	5	178
213829	20	183	215859	5	178	219445	5	178
213830	20	183	215862	5	178	219446	5	178
213831	20	183	215863	5	178	219527	5	166
213832	20	183	215907	5	164	219528	5	166
213833	20	182	215908	5	164	219529	5	166
213834	20	182	215909	5	164	219530	5	166
213961	5	194	215910	5	164	219531	5	166
213962	5	195	215911	5	164	219532	5	166
213963	5	195	215912	5	164	219586	5	177
213964	5	195	215922	5	228	219588	5	177
213965	5	195	216254	5	179	219589	5	177
213966	5	195	216255	5	179	219590	5	177
213967	5	195	216256	5	179	219591	5	176
213968	5	195	216257	5	179	219592	5	176
213969	5	195	216258	5	180	219593	5	176
214030	5	196	216259	5	180	219594	5	176
214031	5	196	216294	5	179	219798	5	176
214032	5	196	216295	5	179	219799	5	176
214033	5	196	216296	5	179	219800	5	176
214034	5	196	216297	5	179	219801	5	176
214035	5	196	216298	5	180	219802	5	176
214190	5	164	216299	5	180	219803	5	176
214191	5	164	216637	5	164	220298	5	143
214208	5	176	216638	5	164	220299	5	143
214209	5	176	216690	5	166	221097	20	182
214210	5	176	216691	5	166	222201	50	198
214211	5	176	216754	20	172	224649	5	164
214216	5	177	216755	20	172	224650	5	164
214217	5	177	216863	20	152	224651	5	164
214218	5	177	216864	20	152	224652	5	164
214219	5	177	216865	20	160	224969	20	171
214455	20	151,159	216866	20	160	224970	20	171
214456	20	151,159	216977	20	171	224971	5	173
214457	20	152,160	216981	20	171	224972	5	173
214458	20	152,160	217036	5	166	224973	5	173
214459	20	152,160	217037	5	166	224974	5	173
214466	5	173	217038	5	166	224975	5	173
214467	5	173	217039	5	166	224976	5	173
214504	20	155	217040	5	166	225092	20	198
214505	20	158	217041	5	166	226489	20	162
214527	20	147	217144	5	176	226490	20	162
214965	20	155	217145	5	176	226733	5	164
214966	20	157	217154	5	177	226734	5	164
214968	20	147,149	217155	5	177	226810	20	151,159
215098	5	194	217676	20	162	226811	5	151,159
215099	5	194	218784	5	164	227051	5	190
215100	5	194	218785	5	164	227052	5	190
215101	5	194	218901	20	151,159	227053	5	190
215102	5	194	218902	20	151,159	227054	5	190
215103	5	194	218903	20	146	227055	5	190
215104	5	194	218904	20	146	227065	5	152,160
215105	5	194	218939	20	147	227388	20	171
215154	5	187	218940	20	147	227538	20	192
215160	5	188	218941	20	155	230010	5	80
215164	5	188	218942	20	155	230011	5	80
215167	10	186	218943	20	149	230012	5	80
215169	10	186	218944	20	149	230013	5	80
215170	5	188	219030	5	177	230014	5	80
215172	10	186	219031	5	177	230015	5	80
215173	5	188	219032	5	176	230016	5	80
215175	10	186	219033	5	176	230017	5	80
215176	5	188	219038	5	173	230020	5	78
215227	5	173	219039	5	173	230021	5	78
215228	5	173	219040	5	173	230022	5	78

№		Page	№		Page	№		Page
230023	5	78	232142	5	120	233865	5	122
230024	5	78	232143	5	120	233866	5	122
230025	5	78	232144	5	120	233867	5	122
230026	5	78	232145	5	120	233941	5	122
230027	5	78	232146	5	120	233942	5	122
230250	5	80	232147	5	120	233943	5	122
230251	5	80	232170	5	120	233944	5	122
230252	5	80	232171	5	120	233945	5	122
230253	5	80	232172	5	120	233946	5	122
230254	5	80	232173	5	120	233947	5	122
230255	5	80	232174	5	120	233990	5	90
230256	5	80	232175	5	120	233991	5	90
230257	5	80	232176	5	120	233992	5	90
230260	5	78	232177	5	120	233993	5	90
230261	5	78	232210	5	118	233994	5	90
230262	5	78	232211	5	118	233995	5	90
230263	5	78	232212	5	118	233996	5	90
230264	5	78	232213	5	118	233997	5	90
230265	5	78	232214	5	118	234000	5	90
230266	5	78	232215	5	118	234001	5	90
230267	5	78	232216	5	118	234002	5	90
230690	5	78	232217	5	118	234003	5	90
230691	5	78	232500	5	118	234004	5	90
230692	5	78	232501	5	118	234005	5	90
230693	5	78	232502	5	118	234006	5	90
230694	5	78	232503	5	118	234007	5	90
230695	5	78	232504	5	118	234030	5	94
230696	5	78	232505	5	118	234031	5	94
230697	5	78	232506	5	118	234032	5	94
230760	5	78	232507	5	118	234033	5	94
230761	5	78	232570	5	118	234034	5	94
230762	5	78	232571	5	118	234035	5	94
230763	5	78	232572	5	118	234036	5	94
230764	5	78	232573	5	118	234037	5	94
230765	5	78	232574	5	118	234040	5	94
230766	5	78	232575	5	118	234041	5	94
230767	5	78	232576	5	118	234042	5	94
230930	5	79	232577	5	118	234043	5	94
230931	5	79	233440	5	122	234044	5	94
230932	5	79	233441	5	122	234045	5	94
230933	5	79	233442	5	122	234046	5	94
230934	5	79	233443	5	122	234047	5	94
230935	5	79	233444	5	122	234180	5	78
230936	5	79	233445	5	122	234181	5	78
230937	5	79	233446	5	122	234182	5	78
231240	5	79	233447	5	122	234183	5	78
231241	5	79	233450	5	122	234184	5	79
231242	5	79	233451	5	122	234185	5	79
231243	5	79	233452	5	122	234200	5	45
231244	5	79	233453	5	122	234201	5	45
231245	5	79	233454	5	122	234202	5	45
231246	5	79	233455	5	122	234203	5	45
231247	5	79	233456	5	122	234204	5	45
231420	5	82	233457	5	122	234205	5	45
231421	5	82	233480	5	133	234206	5	45
231422	5	82	233481	5	133	234207	5	45
231423	5	82	233482	5	133	234220	5	49
231424	5	82	233483	5	133	234221	5	49
231425	5	82	233484	5	133	234222	5	49
231426	5	82	233485	5	133	234223	5	49
231427	5	82	233486	5	133	234224	5	49
231430	5	82	233487	5	133	234225	5	49
231431	5	82	233571	5	119	234226	5	49
231432	5	82	233572	5	119	234227	5	49
231433	5	82	233573	5	119	234230	5	46
231434	5	82	233574	5	119	234231	5	46
231435	5	82	233575	5	119	234232	5	46
231436	5	82	233576	5	119	234233	5	46
231437	5	82	233577	5	119	234234	5	46
231460	5	82	233671	5	123	234235	5	46
231461	5	82	233672	5	123	234236	5	46
231462	5	82	233673	5	123	234237	5	46
231463	5	82	233674	5	123	234250	5	50
231464	5	82	233675	5	123	234251	5	50
231465	5	82	233676	5	123	234252	5	50
231466	5	82	233677	5	123	234253	5	50
231467	5	82	233681	5	119	234254	5	50
231470	5	82	233682	5	119	234255	5	50
231471	5	82	233683	5	119	234256	5	50
231472	5	82	233684	5	119	234257	5	50
231473	5	82	233685	5	119	234270	5	100
231474	5	82	233686	5	119	234271	5	100
231475	5	82	233687	5	119	234272	5	100
231476	5	82	233751	5	124	234273	5	100
231477	5	82	233752	5	124	234274	5	100
232010	5	118	233753	5	124	234275	5	100
232011	5	118	233754	5	124	234276	5	100
232012	5	118	233755	5	124	234277	5	100
232013	5	118	233756	5	124	234280	5	49
232014	5	118	233757	5	124	234281	5	49
232015	5	118	233860	5	122	234282	5	49
232016	5	118	233861	5	122	234283	5	49
232017	5	118	233862	5	122	234284	5	49
232140	5	120	233863	5	122	234285	5	49
232141	5	120	233864	5	122	234286	5	49





№		Page	№		Page	№		Page
234964	5	121	235353	5	45	235902	5	85
234965	5	121	235354	5	45	235903	5	85
234966	5	121	235355	5	45	235904	5	85
234967	5	121	235356	5	45	235905	5	85
234970	5	129	235357	5	45	235906	5	85
234971	5	129	235370	5	47	235907	5	85
234972	5	129	235371	5	47	236000	5	80
234973	5	129	235372	5	47	236001	5	80
234974	5	129	235373	5	47	236002	5	80
234975	5	129	235374	5	47	236003	5	80
234976	5	129	235375	5	47	236004	5	80
234977	5	129	235376	5	47	236005	5	80
234980	5	126	235377	5	47	236006	5	80
234981	5	126	235380	5	47	236007	5	80
234982	5	126	235381	5	47	236010	5	88
234983	5	126	235382	5	47	236011	5	88
234984	5	126	235383	5	47	236012	5	88
234985	5	126	235384	5	47	236013	5	88
234986	5	126	235385	5	47	236014	5	88
234987	5	126	235386	5	47	236015	5	88
234990	5	121	235387	5	47	236016	5	88
234991	5	121	235770	5	44	236017	5	88
234992	5	121	235771	5	44	236020	5	89
234993	5	121	235772	5	44	236021	5	89
234994	5	121	235773	5	44	236022	5	89
234995	5	121	235774	5	44	236023	5	89
234996	5	121	235775	5	44	236024	5	89
234997	5	121	235776	5	44	236025	5	89
235000	5	129	235777	5	44	236026	5	89
235001	5	129	235780	5	44	236027	5	89
235002	5	129	235781	5	44	236030	5	81
235003	5	129	235782	5	44	236031	5	81
235004	5	129	235783	5	44	236032	5	81
235005	5	129	235784	5	44	236033	5	81
235006	5	129	235785	5	44	236034	5	81
235007	5	129	235786	5	44	236035	5	81
235010	5	126	235787	5	44	236036	5	81
235011	5	126	235800	5	88	236037	5	81
235012	5	126	235801	5	88	236050	5	92
235013	5	126	235802	5	88	236051	5	92
235014	5	126	235803	5	88	236052	5	92
235015	5	126	235804	5	88	236053	5	92
235016	5	126	235805	5	88	236054	5	92
235017	5	126	235806	5	88	236055	5	92
235110	5	90	235807	5	88	236056	5	92
235111	5	90	235810	5	84	236057	5	92
235112	5	90	235811	5	84	236070	5	93
235113	5	90	235812	5	84	236071	5	93
235114	5	90	235813	5	84	236072	5	93
235115	5	90	235814	5	84	236073	5	93
235116	5	90	235815	5	84	236074	5	93
235117	5	90	235816	5	84	236075	5	93
235120	5	90	235817	5	84	236076	5	93
235121	5	90	235820	5	84	236077	5	93
235122	5	90	235821	5	84	236590	5	86
235123	5	90	235822	5	84	236591	5	86
235124	5	90	235823	5	84	236592	5	86
235125	5	90	235824	5	84	236593	5	86
235126	5	90	235825	5	84	236594	5	86
235127	5	90	235826	5	84	236595	5	86
235150	5	94	235827	5	84	236596	5	86
235151	5	94	235840	5	88	236597	5	86
235152	5	94	235841	5	88	236600	5	86
235153	5	94	235842	5	88	236601	5	86
235154	5	94	235843	5	88	236602	5	86
235155	5	94	235844	5	88	236603	5	86
235156	5	94	235845	5	88	236604	5	86
235157	5	94	235846	5	88	236605	5	86
235160	5	94	235847	5	88	236606	5	86
235161	5	94	235850	5	84	236607	5	86
235162	5	94	235851	5	84	236810	5	130
235163	5	94	235852	5	84	236811	5	130
235164	5	94	235853	5	84	236812	5	130
235165	5	94	235854	5	84	236813	5	130
235166	5	94	235855	5	84	236814	5	130
235167	5	94	235856	5	84	236815	5	130
235290	5	124	235857	5	84	236816	5	130
235291	5	124	235860	5	84	236817	5	130
235292	5	124	235861	5	84	236820	5	129
235293	5	124	235862	5	84	236821	5	129
235294	5	124	235863	5	84	236822	5	129
235295	5	124	235864	5	84	236823	5	129
235296	5	124	235865	5	84	236824	5	129
235297	5	124	235866	5	84	236825	5	129
235340	5	45	235867	5	84	236826	5	129
235341	5	45	235890	5	85	236827	5	129
235342	5	45	235891	5	85	236830	5	127
235343	5	45	235892	5	85	236831	5	127
235344	5	45	235893	5	85	236832	5	127
235345	5	45	235894	5	85	236833	5	127
235346	5	45	235895	5	85	236834	5	127
235347	5	45	235896	5	85	236835	5	127
235350	5	45	235897	5	85	236836	5	127
235351	5	45	235900	5	85	236837	5	127
235352	5	45	235901	5	85	236840	5	123





№		Page	№		Page	№		Page
236841	5	123	237276	5	64	237604	5	79
236842	5	123	237277	5	64	237605	5	79
236843	5	123	237280	5	64	237606	5	79
236844	5	123	237281	5	64	237607	5	79
236845	5	123	237282	5	64	237620	5	85
236846	5	123	237283	5	64	237621	5	85
236847	5	123	237284	5	64	237622	5	85
236850	5	128	237285	5	64	237623	5	85
236851	5	128	237286	5	64	237624	5	85
236852	5	128	237287	5	64	237625	5	85
236853	5	128	237300	5	69	237626	5	85
236854	5	128	237301	5	69	237627	5	85
236855	5	128	237302	5	69	237630	5	85
236856	5	128	237303	5	69	237631	5	85
236857	5	128	237304	5	69	237632	5	85
237010	5	63	237305	5	69	237633	5	85
237011	5	63	237306	5	69	237634	5	85
237012	5	63	237307	5	69	237635	5	85
237013	5	63	23731	100	156	237636	5	85
237014	5	63	237320	5	60	237637	5	85
237015	5	63	237321	5	60	237650	5	47
237016	5	63	237322	5	60	237651	5	47
237017	5	63	237323	5	60	237652	5	47
237140	5	81	237324	5	60	237653	5	47
237141	5	81	237325	5	60	237654	5	47
237142	5	81	237326	5	60	237655	5	47
237143	5	81	237327	5	60	237656	5	47
237144	5	81	237330	5	60	237657	5	47
237145	5	81	237331	5	60	237660	5	47
237146	5	81	237332	5	60	237661	5	47
237147	5	81	237333	5	60	237662	5	47
237150	5	57	237334	5	60	237663	5	47
237151	5	57	237335	5	60	237664	5	47
237152	5	57	237336	5	60	237665	5	47
237153	5	57	237337	5	60	237666	5	47
237154	5	57	237350	5	66	237667	5	47
237155	5	57	237351	5	66	237680	5	48
237156	5	57	237352	5	66	237681	5	48
237157	5	57	237353	5	66	237682	5	48
237160	5	131	237354	5	66	237683	5	48
237161	5	131	237355	5	66	237684	5	48
237162	5	131	237356	5	66	237685	5	48
237163	5	131	237357	5	66	237686	5	48
237164	5	131	237370	5	60	237687	5	48
237165	5	131	237371	5	60	237690	5	48
237166	5	131	237372	5	60	237691	5	48
237167	5	131	237373	5	60	237692	5	48
237173	5	132	237374	5	60	237693	5	48
237174	5	132	237375	5	60	237694	5	48
237180	5	63	237376	5	60	237695	5	48
237181	5	63	237377	5	60	237696	5	48
237182	5	63	237380	5	60	237697	5	48
237183	5	63	237381	5	60	237730	5	52
237184	5	63	237382	5	60	237731	5	52
237185	5	63	237383	5	60	237732	5	52
237186	5	63	237384	5	60	237733	5	52
237187	5	63	237385	5	60	237734	5	52
237200	5	68	237386	5	60	237735	5	52
237201	5	68	237387	5	60	237736	5	52
237202	5	68	237390	5	61	237737	5	52
237203	5	68	237391	5	61	237750	5	52
237204	5	68	237392	5	61	237751	5	52
237205	5	68	237393	5	61	237752	5	52
237206	5	68	237394	5	61	237753	5	52
237207	5	68	237395	5	61	237754	5	52
237220	5	63	237396	5	61	237755	5	52
237221	5	63	237397	5	61	237756	5	52
237222	5	63	237400	5	61	237757	5	52
237223	5	63	237401	5	61	237760	5	55
237224	5	63	237402	5	61	237761	5	55
237225	5	63	237403	5	61	237762	5	55
237226	5	63	237404	5	61	237763	5	55
237227	5	63	237405	5	61	237764	5	55
237230	5	63	237406	5	61	237765	5	55
237231	5	63	237407	5	61	237766	5	55
237232	5	63	237480	5	66	237767	5	55
237233	5	63	237481	5	66	237790	5	52
237234	5	63	237482	5	66	237791	5	52
237235	5	63	237483	5	66	237792	5	52
237236	5	63	237484	5	66	237793	5	52
237237	5	63	237485	5	66	237794	5	52
237250	5	68	237486	5	66	237795	5	52
237251	5	68	237487	5	66	237796	5	52
237252	5	68	237590	5	79	237797	5	52
237253	5	68	237591	5	79	237810	5	52
237254	5	68	237592	5	79	237811	5	52
237255	5	68	237593	5	79	237812	5	52
237256	5	68	237594	5	79	237813	5	52
237257	5	68	237595	5	79	237814	5	52
237270	5	64	237596	5	79	237815	5	52
237271	5	64	237597	5	79	237816	5	52
237272	5	64	237600	5	79	237817	5	52
237273	5	64	237601	5	79	237820	5	55
237274	5	64	237602	5	79	237821	5	55
237275	5	64	237603	5	79	237822	5	55





№		Page	№		Page	№		Page
237823	5	55	238062	5	50	238351	5	96
237824	5	55	238063	5	50	238352	5	96
237825	5	55	238064	5	50	238353	5	96
237826	5	55	238065	5	50	238354	5	96
237827	5	55	238066	5	50	238355	5	96
237850	5	44	238067	5	50	238356	5	96
237851	5	44	238090	5	54	238357	5	96
237852	5	44	238091	5	54	238360	5	96
237853	5	44	238092	5	54	238361	5	96
237854	5	44	238093	5	54	238362	5	96
237855	5	44	238094	5	54	238363	5	96
237856	5	44	238095	5	54	238364	5	96
237857	5	44	238096	5	54	238365	5	96
237870	5	44	238097	5	54	238366	5	96
237871	5	44	238110	5	54	238367	5	96
237872	5	44	238111	5	54	238370	5	51
237873	5	44	238112	5	54	238371	5	51
237874	5	44	238113	5	54	238372	5	51
237875	5	44	238114	5	54	238373	5	51
237876	5	44	238115	5	54	238374	5	51
237877	5	44	238116	5	54	238375	5	51
237880	5	49	238117	5	54	238376	5	51
237881	5	49	238120	5	56	238377	5	51
237882	5	49	238121	5	56	238420	5	51
237883	5	49	238122	5	56	238421	5	51
237884	5	49	238123	5	56	238422	5	51
237885	5	49	238124	5	56	238423	5	51
237886	5	49	238125	5	56	238424	5	51
237887	5	49	238126	5	56	238425	5	51
237910	5	53	238127	5	56	238426	5	51
237911	5	53	238150	5	55	238427	5	51
237912	5	53	238151	5	55	238462	5	89
237913	5	53	238152	5	55	238482	5	108
237914	5	53	238153	5	55	238500	5	107
237915	5	53	238154	5	55	238501	5	107
237916	5	53	238155	5	55	238502	5	107
237917	5	53	238156	5	55	238503	5	107
237930	5	53	238157	5	55	238504	5	107
237931	5	53	238170	5	55	238505	5	107
237932	5	53	238171	5	55	238506	5	107
237933	5	53	238172	5	55	238507	5	107
237934	5	53	238173	5	55	238520	5	108
237935	5	53	238174	5	55	238521	5	108
237936	5	53	238175	5	55	238522	5	108
237937	5	53	238176	5	55	238523	5	108
237940	5	56	238177	5	55	238524	5	108
237941	5	56	238180	5	56	238525	5	108
237942	5	56	238181	5	56	238526	5	108
237943	5	56	238182	5	56	238527	5	108
237944	5	56	238183	5	56	238540	5	108
237945	5	56	238184	5	56	238541	5	108
237946	5	56	238185	5	56	238542	5	108
237947	5	56	238186	5	56	238543	5	108
237970	5	53	238187	5	56	238544	5	108
237971	5	53	238210	5	48	238545	5	108
237972	5	53	238211	5	48	238546	5	108
237973	5	53	238212	5	48	238547	5	108
237974	5	53	238213	5	48	238560	5	83
237975	5	53	238214	5	48	238561	5	83
237976	5	53	238215	5	48	238562	5	83
237977	5	53	238216	5	48	238563	5	83
237990	5	53	238217	5	48	238564	5	83
237991	5	53	238230	5	48	238565	5	83
237992	5	53	238231	5	48	238566	5	83
237993	5	53	238232	5	48	238567	5	83
237994	5	53	238233	5	48	238570	5	83
237995	5	53	238234	5	48	238571	5	83
237996	5	53	238235	5	48	238572	5	83
237997	5	53	238236	5	48	238573	5	83
238000	5	56	238237	5	48	238574	5	83
238001	5	56	238240	5	51	238575	5	83
238002	5	56	238241	5	51	238576	5	83
238003	5	56	238242	5	51	238577	5	83
238004	5	56	238243	5	51	238610	5	102
238005	5	56	238244	5	51	238611	5	102
238006	5	56	238245	5	51	238612	5	102
238007	5	56	238246	5	51	238613	5	102
238030	5	46	238247	5	51	238614	5	102
238031	5	46	238270	5	54	238615	5	102
238032	5	46	238271	5	54	238616	5	102
238033	5	46	238272	5	54	238617	5	102
238034	5	46	238273	5	54	238621	5	102
238035	5	46	238274	5	54	238622	5	102
238036	5	46	238275	5	54	238623	5	102
238037	5	46	238276	5	54	238624	5	102
238050	5	46	238277	5	54	238625	5	102
238051	5	46	238290	5	54	238626	5	102
238052	5	46	238291	5	54	238627	5	102
238053	5	46	238292	5	54	238660	5	95
238054	5	46	238293	5	54	238661	5	95
238055	5	46	238294	5	54	238662	5	95
238056	5	46	238295	5	54	238663	5	95
238057	5	46	238296	5	54	238664	5	95
238060	5	50	238297	5	54	238665	5	95
238061	5	50	238350	5	96	238666	5	95









№		Page	№		Page	№		Page
238667	5	95	239075	5	64	239274	5	66
238670	5	95	239076	5	64	239275	5	66
238671	5	95	239077	5	64	239276	5	66
238672	5	95	239090	5	58	239277	5	66
238673	5	95	239091	5	58	239300	5	67
238674	5	95	239092	5	58	239301	5	67
238675	5	95	239093	5	58	239302	5	67
238676	5	95	239094	5	58	239303	5	67
238677	5	95	239095	5	58	239304	5	67
238710	5	83	239096	5	58	239305	5	67
238711	5	83	239097	5	58	239306	5	67
238712	5	83	239100	5	58	239307	5	67
238713	5	83	239101	5	58	239320	5	61
238714	5	83	239102	5	58	239321	5	61
238715	5	83	239103	5	58	239322	5	61
238716	5	83	239104	5	58	239323	5	61
238717	5	83	239105	5	58	239324	5	61
238720	5	83	239106	5	58	239325	5	61
238721	5	83	239107	5	58	239326	5	61
238722	5	83	239120	5	65	239327	5	61
238723	5	83	239121	5	65	239330	5	61
238724	5	83	239122	5	65	239331	5	61
238725	5	83	239123	5	65	239332	5	61
238726	5	83	239124	5	65	239333	5	61
238727	5	83	239125	5	65	239334	5	61
238760	5	102	239126	5	65	239335	5	61
238761	5	102	239127	5	65	239336	5	61
238762	5	102	239140	5	58	239337	5	61
238763	5	102	239141	5	58	239350	5	67
238764	5	102	239142	5	58	239351	5	67
238765	5	102	239143	5	58	239352	5	67
238766	5	102	239144	5	58	239353	5	67
238767	5	102	239145	5	58	239354	5	67
238771	5	102	239146	5	58	239355	5	67
238772	5	102	239147	5	58	239356	5	67
238773	5	102	239150	5	58	239357	5	67
238774	5	102	239151	5	58	239370	5	62
238775	5	102	239152	5	58	239371	5	62
238776	5	102	239153	5	58	239372	5	62
238777	5	102	239154	5	58	239373	5	62
238810	5	95	239155	5	58	239374	5	62
238811	5	95	239156	5	58	239375	5	62
238812	5	95	239157	5	58	239376	5	62
238813	5	95	239170	5	65	239377	5	62
238814	5	95	239171	5	65	239380	5	62
238815	5	95	239172	5	65	239381	5	62
238816	5	95	239173	5	65	239382	5	62
238817	5	95	239174	5	65	239383	5	62
238820	5	95	239175	5	65	239384	5	62
238821	5	95	239176	5	65	239385	5	62
238822	5	95	239177	5	65	239386	5	62
238823	5	95	239190	5	59	239387	5	62
238824	5	95	239191	5	59	239400	5	67
238825	5	95	239192	5	59	239401	5	67
238826	5	95	239193	5	59	239402	5	67
238827	5	95	239194	5	59	239403	5	67
23883	100	148	239195	5	59	239404	5	67
23886	100	156	239196	5	59	239405	5	67
239000	5	57	239197	5	59	239406	5	67
239001	5	57	239200	5	59	239407	5	67
239002	5	57	239201	5	59	239420	5	62
239003	5	57	239202	5	59	239421	5	62
239004	5	57	239203	5	59	239422	5	62
239005	5	57	239204	5	59	239423	5	62
239006	5	57	239205	5	59	239424	5	62
239007	5	57	239206	5	59	239425	5	62
239020	5	64	239207	5	59	239426	5	62
239021	5	64	239220	5	65	239427	5	62
239022	5	64	239221	5	65	239430	5	62
239023	5	64	239222	5	65	239431	5	62
239024	5	64	239223	5	65	239432	5	62
239025	5	64	239224	5	65	239433	5	62
239026	5	64	239225	5	65	239434	5	62
239027	5	64	239226	5	65	239435	5	62
239040	5	57	239227	5	65	239436	5	62
239041	5	57	239240	5	59	239437	5	62
239042	5	57	239241	5	59	239450	5	68
239043	5	57	239242	5	59	239451	5	68
239044	5	57	239243	5	59	239452	5	68
239045	5	57	239244	5	59	239453	5	68
239046	5	57	239245	5	59	239454	5	68
239047	5	57	239246	5	59	239455	5	68
239050	5	57	239247	5	59	239456	5	68
239051	5	57	239250	5	59	239457	5	68
239052	5	57	239251	5	59	239470	5	104
239053	5	57	239252	5	59	239471	5	104
239054	5	57	239253	5	59	239472	5	104
239055	5	57	239254	5	59	239473	5	104
239056	5	57	239255	5	59	239474	5	104
239057	5	57	239256	5	59	239475	5	104
239070	5	64	239257	5	59	239476	5	104
239071	5	64	239270	5	66	239477	5	104
239072	5	64	239271	5	66	239480	5	104
239073	5	64	239272	5	66	239481	5	104
239074	5	64	239273	5	66	239482	5	104



№		Page	№		Page	№		Page
239483	5	104	240786	5	120	241294	5	30
239484	5	104	240787	5	120	241295	5	30
239485	5	104	240791	5	131	241296	5	30
239486	5	104	240792	5	131	241297	5	30
239487	5	104	240793	5	131	241298	5	30
239490	5	98	240794	5	131	241310	5	19
239491	5	98	240795	5	131	241311	5	19
239492	5	98	240796	5	131	241312	5	19
239493	5	98	240797	5	131	241313	5	19
239494	5	98	240801	5	131	241314	5	19
239495	5	98	240802	5	131	241315	5	19
239496	5	98	240803	5	131	241316	5	19
239497	5	98	240804	5	131	241317	5	19
239500	5	98	240805	5	131	241318	5	19
239501	5	98	240806	5	131	241320	5	27
239502	5	98	240807	5	131	241321	5	27
239503	5	98	240811	5	132	241322	5	27
239504	5	98	240812	5	132	241323	5	27
239505	5	98	240813	5	132	241324	5	27
239506	5	98	240814	5	132	241325	5	27
239507	5	98	240815	5	132	241326	5	27
239510	5	91	240816	5	132	241327	5	27
239511	5	91	240817	5	132	241328	5	27
239512	5	91	241180	5	19	241340	5	21
239513	5	91	241181	5	19	241341	5	21
239514	5	91	241182	5	19	241342	5	21
239515	5	91	241183	5	19	241343	5	21
239516	5	91	241184	5	19	241344	5	21
239517	5	91	241185	5	19	241345	5	21
239520	5	91	241186	5	19	241346	5	21
239521	5	91	241187	5	19	241347	5	21
239522	5	91	241188	5	19	241348	5	21
239523	5	91	241190	5	27	241360	5	28
239524	5	91	241191	5	27	241361	5	28
239525	5	91	241192	5	27	241362	5	28
239526	5	91	241193	5	27	241363	5	28
239527	5	91	241194	5	27	241364	5	28
239730	5	105	241195	5	27	241365	5	28
239731	5	105	241196	5	27	241366	5	28
239732	5	105	241197	5	27	241367	5	28
239733	5	105	241198	5	27	241368	5	28
239734	5	105	241210	5	20	241380	5	23
239735	5	105	241211	5	20	241381	5	23
239736	5	105	241212	5	20	241382	5	23
239737	5	105	241213	5	20	241383	5	23
239740	5	105	241214	5	20	241384	5	23
239741	5	105	241215	5	20	241385	5	23
239742	5	105	241216	5	20	241386	5	23
239743	5	105	241217	5	20	241387	5	23
239744	5	105	241218	5	20	241388	5	23
239745	5	105	241224	5	22	241390	5	29
239746	5	105	241225	5	22	241391	5	29
239747	5	105	241226	5	22	241392	5	29
239750	5	98	241227	5	22	241393	5	29
239751	5	98	241228	5	22	241394	5	29
239752	5	98	241230	5	28	241395	5	29
239753	5	98	241231	5	28	241396	5	29
239754	5	98	241232	5	28	241397	5	29
239755	5	98	241233	5	28	241398	5	29
239756	5	98	241234	5	28	241410	5	24
239757	5	98	241235	5	28	241411	5	24
239760	5	98	241236	5	28	241412	5	24
239761	5	98	241237	5	28	241413	5	24
239762	5	98	241238	5	28	241414	5	24
239763	5	98	241250	5	22	241415	5	24
239764	5	98	241251	5	22	241416	5	24
239765	5	98	241252	5	22	241417	5	24
239766	5	98	241253	5	22	241418	5	24
239767	5	98	241254	5	22	241420	5	30
240260	5	92	241255	5	22	241421	5	30
240261	5	92	241256	5	22	241422	5	30
240262	5	92	241257	5	22	241423	5	30
240270	5	92	241258	5	22	241424	5	30
240271	5	92	241260	5	29	241425	5	30
240272	5	92	241261	5	29	241426	5	30
240281	5	124	241262	5	29	241427	5	30
240282	5	124	241263	5	29	241428	5	30
240283	5	124	241264	5	29	241440	5	20
240284	5	124	241265	5	29	241441	5	20
240285	5	124	241266	5	29	241442	5	20
240286	5	124	241267	5	29	241443	5	20
240287	5	124	241268	5	29	241444	5	20
240460	5	89	241280	5	24	241445	5	20
240461	5	89	241281	5	24	241446	5	20
240462	5	89	241282	5	24	241447	5	20
240463	5	89	241283	5	24	241448	5	20
240464	5	89	241284	5	24	241450	5	28
240465	5	89	241285	5	24	241451	5	28
240466	5	89	241286	5	24	241452	5	28
240467	5	89	241287	5	24	241453	5	28
240781	5	120	241288	5	24	241454	5	28
240782	5	120	241290	5	30	241455	5	28
240783	5	120	241291	5	30	241456	5	28
240784	5	120	241292	5	30	241457	5	28
240785	5	120	241293	5	30	241458	5	28



№		Page	№		Page	№		Page
241470	5	21	241662	5	20	241790	5	25
241471	5	21	241663	5	20	241791	5	25
241472	5	21	241664	5	20	241792	5	25
241473	5	21	241665	5	20	241793	5	25
241474	5	21	241666	5	20	241794	5	25
241475	5	21	241667	5	20	241795	5	25
241476	5	21	241668	5	20	241796	5	25
241477	5	21	241670	5	22	241797	5	25
241478	5	21	241672	5	22	241798	5	25
241490	5	29	241674	5	22	241800	5	25
241491	5	29	241675	5	22	241801	5	25
241492	5	29	241676	5	22	241802	5	25
241493	5	29	241677	5	22	241803	5	25
241494	5	29	241678	5	22	241804	5	25
241495	5	29	241680	5	22	241810	5	26
241496	5	29	241681	5	22	241811	5	26
241497	5	29	241682	5	22	241812	5	26
241498	5	29	241683	5	22	241813	5	26
241510	5	23	241684	5	22	241814	5	26
241511	5	23	241685	5	22	241820	5	26
241512	5	23	241686	5	22	241821	5	26
241513	5	23	241687	5	22	241822	5	26
241514	5	23	241688	5	22	241823	5	26
241515	5	23	241690	5	24	241824	5	26
241516	5	23	241691	5	24	241850	10	138
241517	5	23	241692	5	24	241852	10	138
241518	5	23	241693	5	24	241854	10	138
241520	5	30	241694	5	24	241860	10	138
241521	5	30	241695	5	24	241862	10	138
241522	5	30	241696	5	24	241864	10	138
241523	5	30	241697	5	24	241931	5	123
241524	5	30	241698	5	24	241932	5	123
241525	5	30	241700	5	19	241933	5	123
241526	5	30	241701	5	19	241934	5	123
241527	5	30	241702	5	19	241935	5	123
241528	5	30	241703	5	19	241936	5	123
241540	5	25	241704	5	19	241937	5	123
241541	5	25	241705	5	19	241940	5	119
241542	5	25	241706	5	19	241941	5	119
241543	5	25	241707	5	19	241942	5	119
241544	5	25	241708	5	19	241943	5	119
241545	5	25	241710	5	21	241944	5	119
241546	5	25	241711	5	21	241945	5	119
241547	5	25	241712	5	21	241946	5	119
241548	5	25	241713	5	21	241947	5	119
241550	5	31	241714	5	21	242090	5	87
241551	5	31	241715	5	21	242091	5	87
241552	5	31	241716	5	21	242092	5	87
241553	5	31	241717	5	21	242093	5	87
241554	5	31	241718	5	21	242094	5	87
241555	5	31	241730	5	23	242100	5	87
241556	5	31	241731	5	23	242101	5	87
241557	5	31	241732	5	23	242102	5	87
241558	5	31	241733	5	23	242103	5	87
241570	5	25	241734	5	23	242104	5	87
241571	5	25	241735	5	23	242110	5	87
241572	5	25	241736	5	23	242111	5	87
241573	5	25	241737	5	23	242112	5	87
241574	5	25	241738	5	23	242113	5	87
241580	5	31	241740	5	24	242114	5	87
241581	5	31	241741	5	24	242120	5	87
241582	5	31	241742	5	24	242121	5	87
241583	5	31	241743	5	24	242122	5	87
241584	5	31	241744	5	24	242123	5	87
241600	5	26	241745	5	24	242124	5	87
241601	5	26	241746	5	24	242130	5	99
241602	5	26	241747	5	24	242131	5	99
241603	5	26	241748	5	24	242132	5	99
241604	5	26	241750	5	20	242133	5	99
241610	5	31	241751	5	20	242134	5	99
241611	5	31	241752	5	20	242140	5	99
241612	5	31	241753	5	20	242141	5	99
241613	5	31	241754	5	20	242142	5	99
241614	5	31	241755	5	20	242143	5	99
241630	5	26	241756	5	20	242144	5	99
241631	5	26	241757	5	20	242150	5	99
241632	5	26	241758	5	20	242151	5	99
241633	5	26	241760	5	21	242152	5	99
241634	5	26	241761	5	21	242153	5	99
241640	5	31	241762	5	21	242154	5	99
241641	5	31	241763	5	21	242160	5	99
241642	5	31	241764	5	21	242161	5	99
241643	5	31	241765	5	21	242162	5	99
241644	5	31	241766	5	21	242163	5	99
241650	5	19	241767	5	21	242164	5	99
241651	5	19	241768	5	21	242170	5	100
241652	5	19	241780	5	23	242171	5	100
241653	5	19	241781	5	23	242172	5	100
241654	5	19	241782	5	23	242173	5	100
241655	5	19	241783	5	23	242174	5	100
241656	5	19	241784	5	23	242180	5	100
241657	5	19	241785	5	23	242181	5	100
241658	5	19	241786	5	23	242182	5	100
241660	5	20	241787	5	23	242183	5	100
241661	5	20	241788	5	23	242184	5	100

№		Page	№		Page	№		Page
242190	5	99	242742	5	87	362002	20	147,150
242191	5	99	242743	5	87	362704	100	200
242192	5	99	242744	5	87	362906	50	201
242193	5	99	242750	5	87	362920	100	199
242194	5	99	242751	5	87	363322	20	147,149
242200	5	99	242752	5	87	363473	1	192
242201	5	99	242753	5	87	363959	100	200
242202	5	99	242754	5	87	364326	100	200
242203	5	99	242780	5	25	364770	20	200
242204	5	99	242781	5	25	364771	20	200
242210	5	105	242782	5	25	364952	100	159
242211	5	105	242783	5	25	364953	100	159
242212	5	105	242784	5	25	367701	1	193
242213	5	105	242790	5	25	367702	1	193
242214	5	105	242791	5	25	369143	50	201
242220	5	105	242792	5	25	369691	100	199
242221	5	105	242793	5	25	38924	50	155
242222	5	105	242800	5	26			
242223	5	105	242801	5	26			
242224	5	105	242802	5	26	40720	20	200
242230	5	106	242803	5	26	43524	50	200
242231	5	106	242804	5	26	43586	50	201
242232	5	106	242810	5	26	43718	100	199
242233	5	106	242811	5	26	44205	100	199
242234	5	106	242812	5	26	44206	100	199
242240	5	106	242813	5	26	44253	50	199
242241	5	106	242814	5	26	44268	100	199
242242	5	106	242820	5	27	44316	100	199
242243	5	106	242821	5	27	44372	50	199
242244	5	106	242822	5	27	44373	50	199
242250	5	106	242823	5	27	458252	100	191
242251	5	106	242824	5	27	458253	100	191
242252	5	106	242830	5	27	458274	1	192
242253	5	106	242831	5	27	466699	1	190
242254	5	106	242832	5	27	466830	1	190
242260	5	106	242833	5	27	466831	1	190
242261	5	106	242834	5	27	466833	1	192
242262	5	106	243570	10	139	466834	1	192
242263	5	106	243572	10	139	466835	1	192
242264	5	106	243574	10	139	466836	1	192
242270	5	106	243580	10	139	466837	1	192
242271	5	106	243582	10	139	466838	1	192
242272	5	106	243584	10	139	466842	1	192
242273	5	106	243590	10	139			
242274	5	106	243592	10	139			
242280	5	106	243594	10	139			
242281	5	106	243680	5	136	50576	20	148
242282	5	106	243681	5	136	50579	20	156
242283	5	106	243682	5	136	55112	100	148
242284	5	106	243683	5	136	55146	5	144
242290	5	86	243684	5	136	55147	5	144
242291	5	86	243690	5	136	55148	5	144
242292	5	86	243691	5	136	55149	5	144
242293	5	86	243692	5	136	55169	10	197
242294	5	86	243693	5	136	55170	10	197
242300	5	86	243694	5	136	55171	10	197
242301	5	86	26617	20	156	55172	10	197
242302	5	86	26755	100	156	55215	10	197
242303	5	86	26799	20	148	55216	10	197
242304	5	86	28603	1	204	55217	10	197
242310	5	105	29776	50	146	55252	50	155
242311	5	105	29787	50	149,157	55395	5	143
242312	5	105	29788	20	150	55396	5	143
242313	5	105				55397	5	143
242314	5	105				55398	5	143
242320	5	105				55399	5	143
242321	5	105	30545	200	147	55484	5	143
242322	5	105	34004	50	149	55485	5	143
242323	5	105	34606	200	162	55486	5	143
242324	5	105	34610	200	162	55487	5	143
242450	10	138	34934	200	159	55488	10	197
242452	10	138	34943	200	154	55489	10	197
242454	10	138	34969	200	154	55490	10	197
242470	5	92	34979	200	154	55491	10	197
242471	5	92	34980	200	154	55985	20	182,182,183
242472	5	92	34981	200	157	55986	20	156
242473	5	92	35250	50	163	55987	50	154
242474	5	92	354358	100	199	55989	20	182,182,183
242480	5	92	354952	20	146	55992	10	187
242481	5	92	354954	20	146	55993	10	186
242482	5	92	354987	20	162	57179	5	143
242483	5	92	355000	20	162	57181	5	143
242484	5	92	357671	200	151	57824	10	186
242720	5	86	357672	200	151	57825	10	186
242721	5	86	357673	100	151	57826	10	186
242722	5	86	357674	100	151	57827	10	186
242723	5	86	358024	50	200	57915	20	184
242724	5	86	360074	100	199	57916	20	184
242730	5	86	360102	100	151	58029	20	184
242731	5	86	360103	100	151	58030	20	184
242732	5	86	360112	20	146	58107	10	187
242733	5	86	360113	20	146	58188	5	143
242734	5	86	360159	20	199	58191	10	189
242740	5	87	360397	50	200	58329	10	187
242741	5	87	360614	20	151	58330	10	187
			360615	20	151	58331	10	187

№ _____  **_ Page**

58333	10	187
58335	10	189
58458	10	187
58463	20	182
58464	20	182, 182, 183
58465	20	184
58467	20	182
58468	20	182, 182, 183
58469	20	184
58574	20	183
58575	20	183
58608	20	183
58609	20	183
58646	50	154
58647	50	154
58648	20	154
58649	20	154
58667	20	156
59391	5	144
59405	10	187
59420	10	146
59421	50	146
59422	20	182
59423	20	182
59424	20	182
59425	20	182
59426	20	183
59427	20	183
59428	20	183
59429	20	183
59430	20	183
59431	20	183
59433	20	184
59900	5	143
59901	5	143

7

757154		204
757155		204
757156		270
757157		204
757158		204
757159		204

9

94019	10	200
94118	50	148
94219	100	200
94322	50	155
96263	100	154
96264	100	154
96305	100	147
96306	100	147
96558	100	162
96561	100	157
96565	100	147
96566	100	147
96660	100	154
96845	100	149
96846	100	149
96861	100	157

**MACO
PROTECT**



MAYER & CO BESCHLÄGE GMBH

ALPENSTRASSE 173
A-5020 SALZBURG
TEL +43 662 6196-0
FAX +43 662 6196-1449
maco@maco.eu
www.maco.eu